



PULSAR REFLECT™

Intelligent Transducer

Instruction Manual



PULSAR REFLECT™ (THIRD EDITION REV 1)

January 2025

Part Number M-080-0-003-1P

COPYRIGHT

© Pulsar Measurement, 2022-2025. All rights reserved. No part of this publication may be reproduced, transmitted, transcribed, stored in a retrieval system, or translated into any language in any form without the written permission of Pulsar Measurement.

WARRANTY AND LIABILITY

Pulsar Measurement guarantees for a period of 2 years from the date of delivery that it will either exchange or repair any part of this product returned to Pulsar Measurement if it is found to be defective in material or workmanship, subject to the defect not being due to unfair wear and tear, misuse, modification or alteration, accident, misapplication, or negligence.

DISCLAIMER

Pulsar Measurement neither gives nor implies any process guarantee for this product and shall have no liability in respect of any loss, injury or damage whatsoever arising out of the application or use of any product or circuit described herein.

Every effort has been made to ensure accuracy of this documentation, but Pulsar Measurement cannot be held liable for any errors.

Pulsar Measurement operates a policy of constant development and improvement and reserves the right to amend technical details, as necessary.

The REFLECT shown on the cover of this manual is used for illustrative purposes only and may not be representative of the actual REFLECT supplied.

CONTACT

For technical support, please contact:

Europe: supporteurope@pulsarmeasurement.com

Outside Europe: supportnorthamerica@pulsarmeasurement.com

If you have any comments or suggestions about this product, please contact:

Europe: europe@pulsarmeasurement.com

Outside Europe: northamerica@pulsarmeasurement.com

Pulsar Measurement website: www.pulsarmeasurement.com

United States

11451 Belcher Road South
Largo,
FL 33773
888-473-9546

Canada

16456 Sixsmith Drive
Long Sault, Ont.
K0C 1P0
855-300-9151

United Kingdom

Cardinal Building, Enigma
Commercial Centre
Sandy's Road, Malvern
WR14 1JJ
00 44 (0)1684 891371

CONTENTS

Chapter 1: Start Here.....	7
About this Manual	7
About Pulsar REFLECT	8
Functional Description	8
Product Specification.....	10
UK Declaration of Conformity	12
EU Declaration of Conformity	13
Chapter 2 Installation.....	14
Unpacking	14
Power Supply Requirements.....	14
Dimensions	15
Outdoor and Open Vessel Installation	19
Front Nose Thread Installation	20
Closed Vessel Installation	21
Cable	22
Typical wiring for a Pulsar REFLECT	22
Preparation for Operation	23
Maintenance	24
Hazardous Area Installation.....	24
Chapter 3 How To Use Your Pulsar REFLECT	29
4-20 mA Device	29
Accessing Parameters.....	30
Hart Commands.....	30
Pulsar REFLECT connection	32
Chapter 4 REFLECT Bluetooth and PC Connectivity.....	33
REFLECT Bluetooth	33
Connecting to Bluetooth.....	33
Home Page	35
Connecting your REFLECT.....	37

Trace Page.....	39
Settings Page.....	41
REFLECT Hart Communicator Software.....	44
Opening Pulsar REFLECT Hart Communicator.....	46
Pulsar REFLECT Hart Communicator Opening Screen.....	47
Menu Strip	47
Shortcut Icons.....	49
Toggle Parameter List	51
Main Screen Selection Tabs.....	51
Main Screen.....	52
Progress Bar	59
Cursor Position.....	59
Transducer	59
Quick start setup	60
Setting up Your Application.....	60
Setting Security Passcodes.....	61
Resetting Factory Defaults.....	62
Chapter 5 Parameter Listing and Description	63
Application.....	63
Operation	63
Distance	66
Data Logs	67
mA Output.....	69
Compensation	70
Stability.....	72
System	72
DATEM.....	75
Volume	77
Conversion.....	77

Breakpoints.....	82
Tables.....	83
Chapter 6 Troubleshooting.....	84
Chapter 7 Disposal.....	85
Transducers.....	85
Controllers.....	85

CHAPTER 1: START HERE...

Congratulations on your purchase of a Pulsar REFLECT Intelligent Transducer Level Monitoring System. This quality system has been developed over many years and represents the latest in high technology Radar level measurement and control. It has been designed to give you years of trouble-free performance, and a few minutes spent reading this operating manual will ensure that your installation is as simple as possible.

About this Manual

It is important that this manual is referred to for correct installation and operation. There are various parts of the manual that offer additional help or information as shown.

Tips



TIP: Look for this icon throughout your Pulsar Measurement manual to find helpful information and answers to frequently asked questions.

Additional Information

Additional Information

At various parts of the manual, you will find sections like this that explain specific things in more detail.

About Pulsar REFLECT



Functional Description

The Pulsar REFLECT Intelligent Transducer is a highly developed RADAR level measurement system which provides non-contacting level measurement for a wide variety of applications in both liquids and solids. Its unique design gives unrivalled performance in echo discrimination and accuracy in a loop powered device.

Housed within a robustly engineered enclosure, the REFLECT Radar is designed for easy installation. The integral REFLECT⁷ILT⁷™ levelling indicator ensures optimal setup with liquids and Bluetooth radio allows local setup and monitoring via any device with a Bluetooth enabled browser (i.e., Google Chrome and Microsoft Edge on a PC or Android, and BlueFy Web BLE Browser on iOS). The primary system communication is via HART modem over 4-20mA loop. For further information on setting up Radar with a controller please consult Pulsar Measurement for assistance.

It gives all the advantages associated with radar technology and offers best-in-class performance with a narrow beam angle. The range is 0.075 to 8 metres (0.25 to 26.2 ft) or 0.075 to 20 metres (0.25 to 65.6 ft). The signal emanates from the curved face of the radar, but for the purposes of measurement it is measured from the front edge of the body.

Easy calibration and maintenance free "fit and forget" performance mean that you can install the REFLECT Level Monitoring System rapidly and with confidence. With calibration being achieved either using a HART programmer/calibrator, or via a PC utilising the Pulsar REFLECT software. The Pulsar REFLECT Intelligent Transducer operates on the FMCW Radar principle and uses 'state of the art' echo extraction technology.

The Reflect-W sensor features an innovative design, which has no extra antenna, that can offer very high performance and effective radar level sensing. And utilises “state of the art” echo extraction technology.

The Pulsar REFLECT Intelligent Transducer comes in two models:

1. R8 with a range from 0.075m (0.25 ft) to 8.00m (26.2 ft).
2. R20 with a range of 0.075m (0.25 ft) to 20.00m (65.6 ft).

These are available in standard cable lengths of 10, 20, 30m, 50m or 100m length, with a range of mounting brackets also available.

Models can be mounted via a rear, 1” BSP (ATEX/UK only) or 1” NPT thread (CFMus only), and there is also an optional 1.5” front thread mounting available, see [Chapter 2 Installation](#) for further details.

Models are available for use in hazardous area installations; zones 0, 1, 2 (gas) and zones 20, 21 and 22 (dust) with Ex ia certification through UKEx, ATEX, and IECEx; or for Class I, Div 1, groups A,B,C,D; Class II, Div 1, groups E,F,G; Class III with Ex ia intrinsically safe certification through FM for the United States and Canada.

The Reflect-W sensor can be fitted with an optional Front Nose Thread Adapter, for direct connection to a process, and is suitable for both BSP and NPT connections. As the Reflect-W has been designed predominantly for use in water and wastewater applications, the 1.5” Front Thread Adapter is available in both BSP and NPT thread configurations for reliable mechanical connection. However, for applications that require air-tight sealing, please contact Pulsar Measurement for further advice.

The Pulsar REFLECT Intelligent Transducer has a 4 to 20mA output which can be programmed to give an output proportional to **level, space, distance or volume**, dependant on the measurement mode selected and provides a ‘fault condition’ alarm of either 3.8mA or 22mA.

Boot time for the REFLECT intelligent Transducer from power up to stable reading: 10 seconds. For 4 to 20mA set proportional to measured level/distance.

Product Specification

PHYSICAL

Dimensions & Mounting	<p>ATEX/UK Model: 135 x 102mm (5.31 x 4.04") Rear thread 1" BSP with M20 adaptor, or choice of optional 1.5" BSP Front Thread Adaptor.</p> <p>FM Model: 162 x 103mm (6.38 x 4.06") maximum. Rear thread 1" NPT with M20 adaptor, or choice of optional 1.5" NPT Front Thread Adaptor</p>
Mounting Options	ANSI or DIN flange front thread adaptor (PVDF)
Weight	All Models: 1.5kg (3.3lbs)
Frequency	All Models: V-Band (63 GHz)
Enclosure material/description	Valox 357U
Transducer cable requirements	2 core screened.
Standard cable lengths	Standard: 5, 10, 20 or 30m (16.4 ft, 32.8ft, 65.5ft or 98.4ft) Optional: 50m or 100m (164ft or 328ft)

ENVIRONMENTAL

Enclosure protection (all models)	IP68 / NEMA 6P
Max. & min. temperature (electronics)	-40 °C to +80 °C (-40°F to 176°F)
Vibration Protection	Fully Potted
Humidity	0 to 99% (non condensating)
Process Pressure	-1 to +3 bar
CE Approval	See EU Declaration of Conformity
UKCA Approval	See UK Declaration of Conformity
Regulatory Approvals	FC, RED, CE, cFMus, UKCA, IECEx, ATEX, UKEx
cFMus Approval	FM23CA0027X, FM23US0037X. Intrinsically safe for Class I, Div 1, Groups A,B,C,D; Class II, Div 1, Groups E,F,G; Class III; T4
Radio Approval	EN 302729 (level probing radar), FCC Part 15C
Hazardous Area Approvals	Zones 0, 1, 2: Ex II 1G Exia IIC T4 Ga, Tamb.= -40 °C to +80 °C. Zones 20, 21, 22 : Ex II 1D Exia IIIC T100 °C Da, Tamb.= -40 °C to +80 °C. Class I, II, III, Division 1, Groups A, B, C, D, E, F, G T4 Class 1, Zone 0, AExia IIC T4, Ga Class 1, Zone 20, AExia IIIC T100°C, Da
WEEE and ROHS	Compliant

PERFORMANCE

Measurement Range	R8: 0.075m (0.24 ft.) to 8.00m (26.24 ft.) R20: 0.075m (0.24 ft.) to 20.00m (65.61 ft.)
Accuracy	All Models: ±2mm (0.08 inch)
Repeatability	All Models: ±1mm (0.04) inch
Beam Angle	All Models: 6°
First Stable Measurement	Cold Boot = 10 seconds, Warm Boot = 5 seconds

OUTPUTS

Digital Communications	HART with DTM
Communication Protocol	HART 7
Analog	4-20mA loop powered, output resolution 1µA
User Indicator	Quad-colour lights with tilt sensor

PROGRAMMING

PC programming (via HART modem and 250 Ohm resistor)	REFLECT PC, and 250 Ohm resistor. (For setup, installation, echo profiles, cloning & troubleshooting).
Programming (via Bluetooth)	REFLECT HTML Application/webpage
Local Wireless Communication	Encrypted Bluetooth with mobile interface (ability to disable)
Wireless Range	4m to 40m (13.1ft to 31.2ft). User Configurable
Program security	Via passcode
Programmed data integrity	Via non-volatile RAM
PC Setup and monitoring	Compatible with Win 7, Win 8 and Win 10

SUPPLY

Power supply	12V min. (mA loop with $R_s = 0\Omega$) 16V min. (HART with $R_s = 250\Omega$) 28V DC max.
Power	3.8 - 22mA
Current Consumption	Current consumption at start-up = 20mA

ACCESSORIES

BReez™ Adaptor	Greatly increases ease of use
Front Thread Adaptor	For compatibility with chemical applications

Pulsar Measurement operates a policy of constant development and improvement and reserve the right to amend technical details, as necessary.

UK Declaration of Conformity**UK DECLARATION OF CONFORMITY****P U L S A R *Reflect Radar sensor.***

This declaration of conformity is issued under the sole responsibility of the manufacturer.

UK legislation	SI 2016/1091 - Electro-Magnetic Compatibility. SI 2017/1206 - Radio equipment. SI 2016/1101 - Electrical safety. SI 2016/1107 - Explosive atmospheres. SI 2012/3032 - Restriction of hazardous substances.
Manufacturer's name	Pulsar Process Measurement Ltd.
Manufacturer's address	Cardinal Building, Enigma Commercial Centre, Sandy's Road, Malvern, Worcestershire, WR14 1JJ, UK.
Apparatus	DC powered level measurement sensor utilising radar technology.
Models	Reflect, all models. (UKEx where approved)
Type of equipment	Measurement and process control.
Standards applied	EN 302729 v2.1.1:2016, radio equipment. BS EN 61326-1:2013 EMC, equipment class industrial. BS EN 61010-1:2010+A1:2019 Safety requirements for electrical equipment for measurement, control and laboratory use. BS EN IEC 60079-0:2018 UKEx general requirements. BS EN 60079-11:2012 UKEx intrinsic safety (Ex ia).
Approved body	Eurofins E&E CML Ltd., #2503.
Role	Issue of UKEx conformity assessment certificate; CML 22UKEX2378X.
Auditing body	CSA Group Testing UK Ltd., #0518.

I declare that the apparatus named above has been tested and complies with the relevant sections of the above referenced standards & legislation.

Signed:

A handwritten signature in black ink, appearing to be "Tim Brown".

Date: 7th September 2022.

Rev. 1.0 .

Name & function:

Tim Brown, electronics engineer.

Pulsar Process Measurement Ltd.

EU Declaration of Conformity**EU DECLARATION OF CONFORMITY****P U L S A R *Reflect Radar sensor.***

This declaration of conformity is issued under the sole responsibility of the manufacturer.

Relevant directive(s)	2014/30/EU - EMC directive and its amending directives. 2014/53/EU - Radio equipment directive and its amending directives. 2014/35/EU - Low Voltage directive and its amending directives. 2014/34/EU - ATEX directive and its amending directives. 2011/65/EU - RoHS directive and its amending directives.
Manufacturer's name	Pulsar Process Measurement Ltd.
Manufacturer's address	Cardinal Building, Enigma Commercial Centre, Sandy's Road, Malvern, Worcestershire, WR14 1JJ, UK.
Apparatus	DC powered level measurement sensor utilising radar technology.
Models	Reflect, all models. (ATEX where approved)
Type of equipment	Measurement and process control.
Standards applied	EN 302729 v2.1.1:2016, radio equipment. EN 61326-1:2013 EMC, equipment class industrial. EN 61010-1:2010+A1:2019 Safety requirements for electrical equipment for measurement, control and laboratory use. EN IEC 60079-0:2018 ATEX general requirements. EN 60079-11:2012 ATEX intrinsic safety (Ex ia).
Notified body	CML B.V., # 2776.
Role	Issue of ATEX and IECEx type examination certificates. CML 22ATEX2377X.
Auditing body	CSA Group Netherlands B.V., # 2813.

I declare that the apparatus named above has been tested and complies with the relevant sections of the above referenced standards & directives.

Signed:

A handwritten signature in black ink, appearing to read "Tim Brown".

Date: 7th September 2022.

Rev. 1.0 .

Name & function: Tim Brown, electronics engineer.

Pulsar Process Measurement Ltd.

CHAPTER 2 INSTALLATION

Unpacking

Important Notice

All shipping cartons should be opened carefully. When using a box cutter, do not plunge the blade deeply into the box, as it could potentially cut or scratch equipment components. Carefully remove equipment from each carton, checking it against the packing list before discarding any packing material. If there is any shortage or obvious shipping damage to the equipment, report it immediately to Pulsar Measurement.

Power Supply Requirements

The Pulsar REFLECT Intelligent Transducer operates from a DC supply of 12 to 28V and will typically draw less than 22mA.

The compact one-piece construction of the Pulsar REFLECT Intelligent Transducer can be mounted easily using either the 1" BSP (ATEX/IECEx only) or 1" NPT (cFMus) read mounting thread and BReez adaptor, or the optional 1.5" BSP or NPT front nose thread attachment (ordered at point of purchase).

When choosing a location to mount the Pulsar REFLECT Intelligent Transducer, bear in mind the following:

- The Pulsar REFLECT signal path should be free of falling material and obstructions such as pipes, beams etc.
- The Pulsar REFLECT should be mounted at least 7.5cm (0.25 feet) above the maximum level of the material and be perpendicular to the surface.
- The ambient temperature is between -40°C and 80°C.
- There should be no high voltage cables or electrical inverter wiring near the transducer cabling.

Important Notice

All electronic products are susceptible to electrostatic shock, so follow proper grounding procedures during installation.

Dimensions

The dimensions of the Pulsar REFLECT Intelligent Transducer are shown below:

Rear Thread Mount 1" BSP

R8 & R20

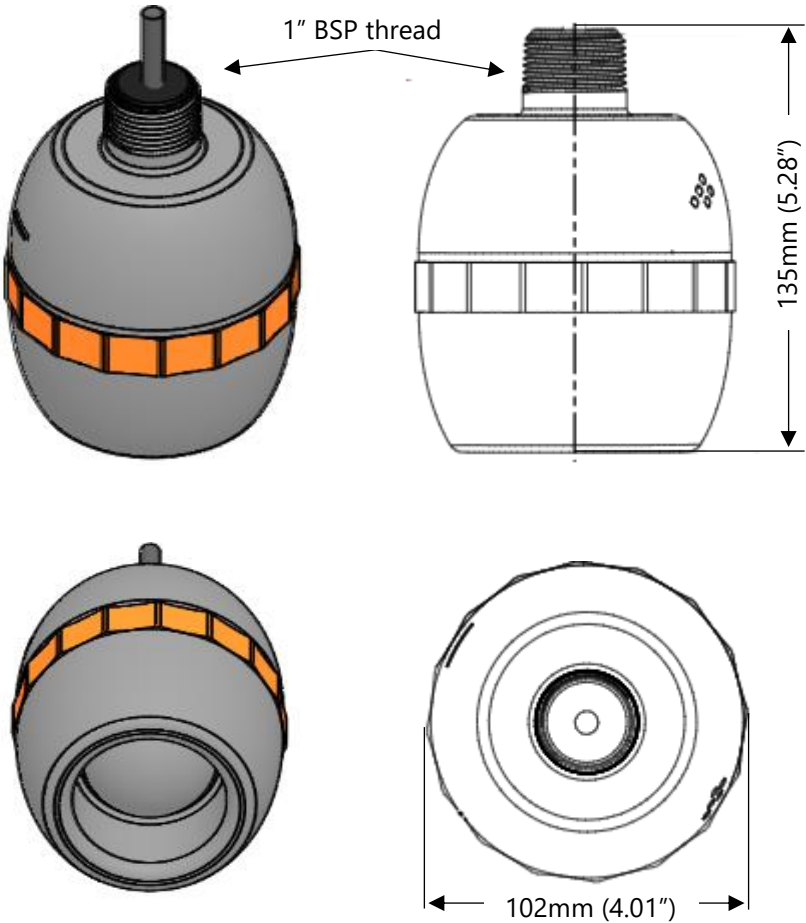

Rear Thread Mount 1" NPT

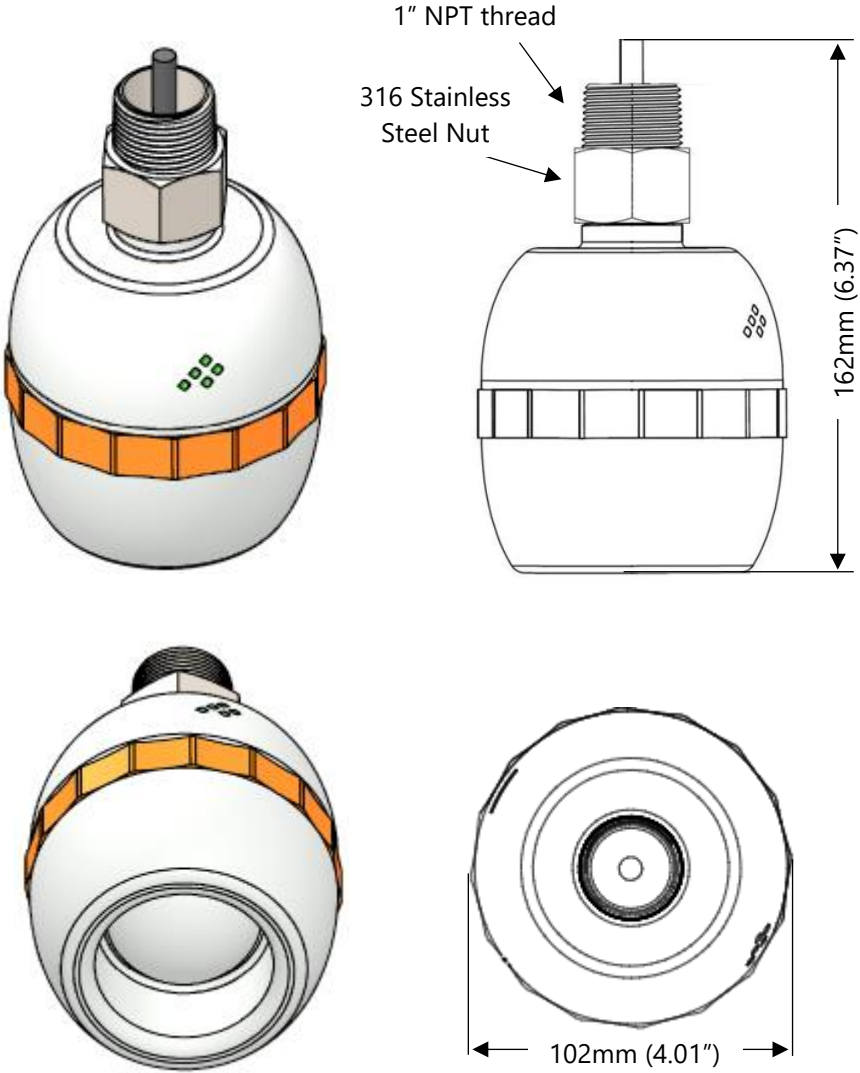

Front Thread Mount 1.5" BSP

R8 & R20

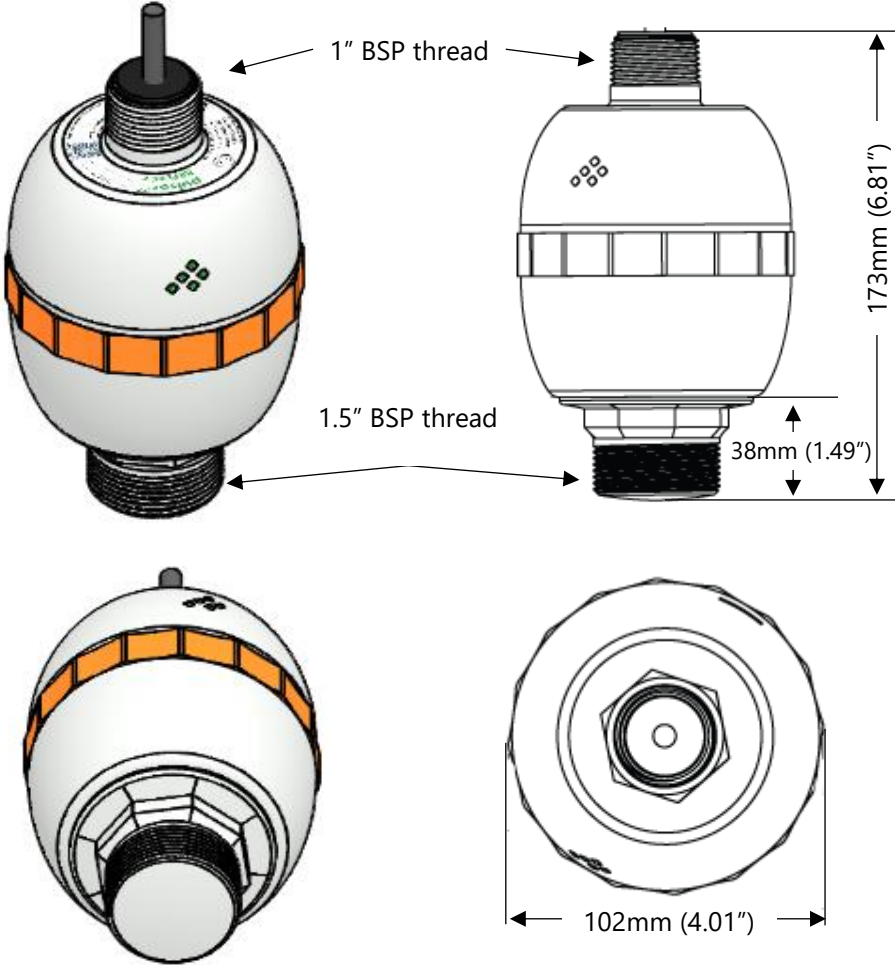

Front Thread Mount 1.5" NPT

R8 & R20

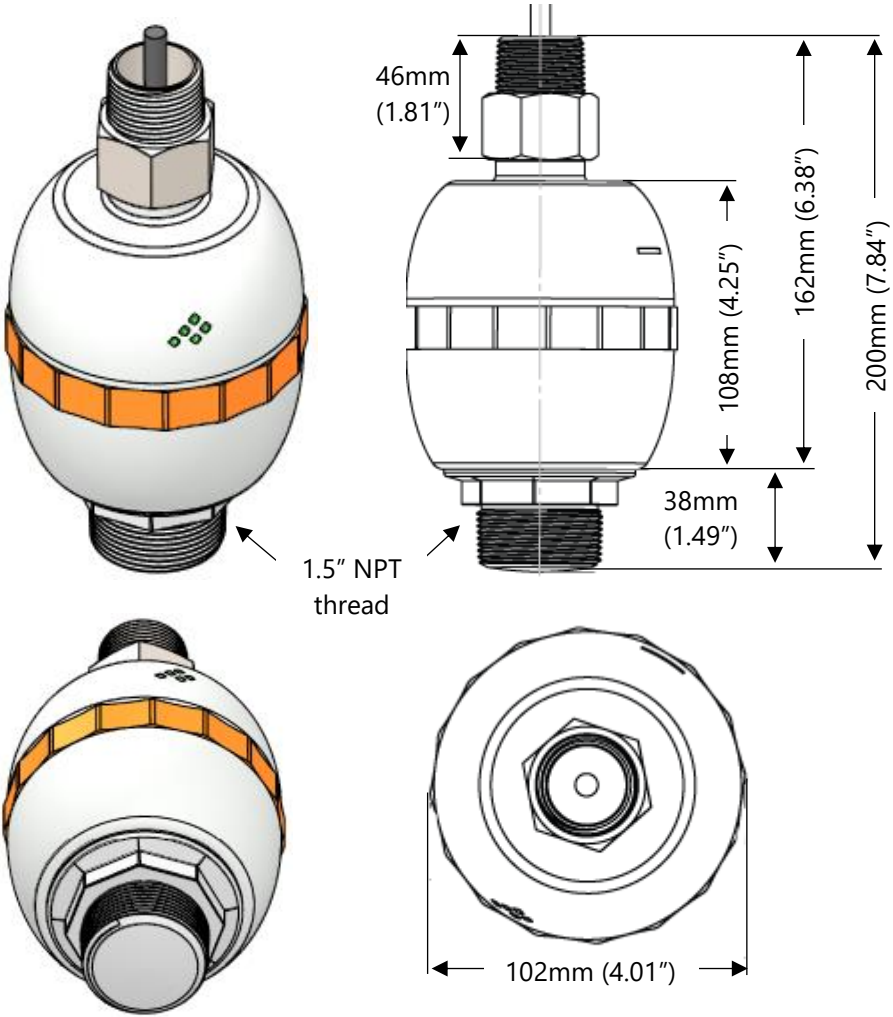

Important Notice
The diagrams shown are for illustrative purposes only.

Outdoor and Open Vessel Installation

The Pulsar REFLECT Intelligent Transducer can be simply mounted on a bracket, suitable for the application and secured using either the 1" BSP rear thread with BReez adaptor (UK & ATEX) or 1" NPT rear adaptor with BReez adaptor (cFMus) or via the 1½" BSP or NPT front thread, dependant on model.

MODEL	RANGE	L = BLANKING
R8	8 metres (26.24 feet)	0.075m (0.25 feet)
R20	20 metres (65.61 feet)	0.075m (0.25 feet)

'L' (Blanking) should, as a minimum be at least that as detailed in the table above but can be greater if required.

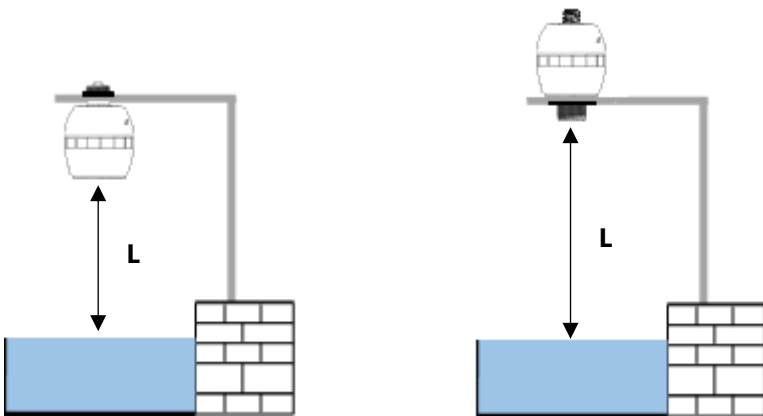

Mounted via Rear 1" BSP/NPT Thread

Mounted via optional 1.5" BSP/NPT Front Nose Thread

Important Notice

Care should be taken when installing the REFLECT with a Front Nose Thread. Please do not use the body of the REFLECT to tighten the sensor, use appropriate tools such as a torque wrench (not exceeding 20Nm), and tighten the octagonal. Ensure that the threaded part is screwed in straight to avoid any damage. Do not attempt to move the fitting if it has been installed incorrectly. Please unscrew, taking care to carry out the installation again.

Front Nose Thread Installation

Care should be taken when installing the REFLECT with a Front Nose Thread.

Please do not use the body of the REFLECT to tighten the sensor, use appropriate tools such as a torque wrench (not exceeding 20Nm), and tighten the octagonal area of the front nose thread (as shown in the diagram below).

Ensure that the threaded part is screwed in straight to avoid any damage. Do not attempt to move the fitting if it has been installed incorrectly.

Please unscrew, taking care to carry out the installation again.

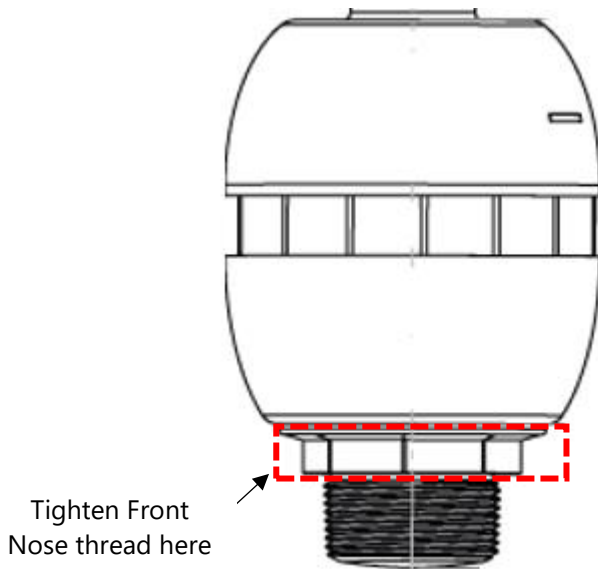

Closed Vessel Installation

"L" should be at least that as detailed in the table above but can be greater if required. The Pulsar REFLECT Intelligent Transducer can be simply screwed into a flange and secured using the rear 1" BSP with M20 adaptor (UK & ATEX) or 1" NPT rear thread or via the 1½" BSP or NPT front thread, dependant on model.

Where a flange and/or gasket is used, ensure chemical compatibility of the materials used. In cases where a metal flange is used it is advisable to fit a suitable gasket between the flange of the Pulsar REFLECT Intelligent Transducer and the connection to the vessel.

Standpipe Installations

When mounting the Pulsar REFLECT Intelligent Transducer to a standpipe care should be taken to ensure that the standpipe is of sufficient diameter with reference to its length, see the table below for details:

DIA. (D)		MAX LENGTH	
mm	inches	mm	inches
100	4	300	12
150	6	420	16
200	8	560	22

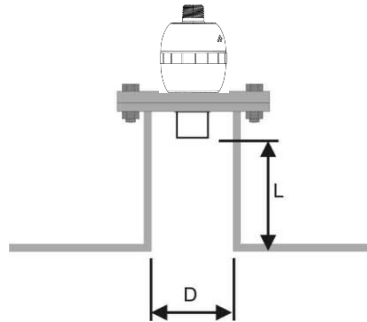

Pulsar REFLECT Flange mounted via Front Nose Thread

When using a standpipe, fixed to the top of a vessel, ensure that the open end of the standpipe is clear of any obstructions such as weld seams, gaskets etc. to avoid unwanted signal returns.

If using standpipes which extend into the vessel, beyond the blanking distance, but not as far as the empty level, then the open end of the standpipe should be cut to an angle of 45°.

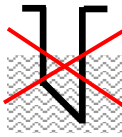

The maximum level (100% of Span) is inside the Blanking Distance.

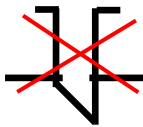

Pipe should be free of obstructions such as weld seams.



Correct standpipe installation

Cable

The Pulsar REFLECT Intelligent Transducer comes with a fitted integral cable, if this cable is extended then the total capacitance must not exceed the limits for the voltage applied.

Typical wiring for a Pulsar REFLECT

The HART modem and PC or HART programmer are used to set up the operation parameters for the Pulsar REFLECT Intelligent Transducer. The output can either be as a 4-20mA current giving level or distance or as a digital signal via a HART master.

The Pulsar REFLECT Intelligent Transducer cable is a twisted pair with overall cable screen. The twisted pair are red and black, connect the red to +ve and the black to -ve. The screen should go to signal ground.

Loop Resistance

For two wire operation, the maximum cable resistance allowable can be calculated from the graph below. For example, if a Pulsar REFLECT Intelligent Transducer was supplied from 24V, the maximum total cable resistance is 650 ohms, for a typical 77 ohm/km cable this would mean a maximum cable length of $650/77 = 8.4\text{km}$, remember this is total cable resistance, so this figure must be divided by 2 to give 4.2km max distance.

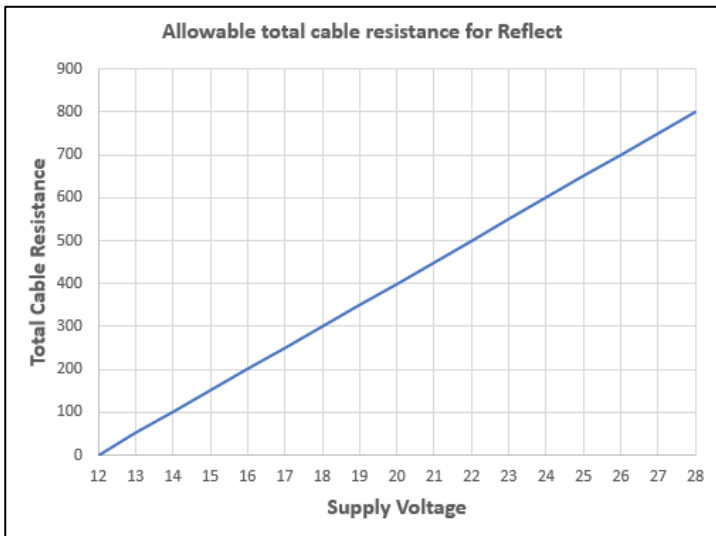

Maximum cable resistance vs supply voltage.

Important Notice

If the equipment is installed or used in a manner not specified in this manual, then the protection provided by the equipment may be impaired.

Preparation for Operation

Before switching on, check the following:

- ✓ The Pulsar REFLECT Intelligent Transducer is mounted correctly.
- ✓ The power supply is correctly installed.
- ✓ Any controlled equipment, e.g., motors & servos, are in a safe & monitored state.

Maintenance

There are no user serviceable parts inside your Pulsar REFLECT Intelligent Transducer, if you experience any problems with the unit, then please contact Pulsar Measurement for advice. To clean the equipment, wipe with a damp cloth. Do not use any solvents on the enclosure.

Hazardous Area Installation

Information specific to Hazardous Area Installation

(Reference European ATEX Directive 2014/34/EU, Annex II, 1.0.6.)/ UK Statutory Instrument 2016/1107.

The following instructions apply to equipment covered by certificate number CML 22ATEX2377X (ATEX Exia), CML 22UKEX2378X (UKEx Ex ia), IECEx CML22.0051X (IECEx Ex ia). Zones 0, 1, 2: Ex II 1G Exia IIC T4 Ga, Tamb.= -40°C to +80°C. Zones 20, 21, 22: Ex II 1D Exia IIIC T100°C Da, Tamb.= -40°C to +80°C.

1. The equipment may be used with flammable gases and vapours with apparatus groups IIC, IIB, and IIA with temperature classes; T1, T2, T3, T4 maximum ambient temperature range -40°C to +80°C.
2. The equipment is only certified for use in ambient temperatures in the range -40°C to +80°C and should not be used outside this range
3. Installation shall be carried out in accordance with the applicable code of practice by suitably trained personnel
4. Repair of this equipment shall be carried out in accordance with the applicable code of practice.
5. If the equipment is likely to meet aggressive substances, then it is the responsibility of the user to take suitable precautions that prevent it from being adversely affected, thus ensuring that the type of protection is not compromised.
 - Aggressive Substances - e.g., acidic liquids or gases that are acids, solvents or alkaline that attack metals or polymeric materials.
 - Suitable Precautions - e.g., regular checks as part of routine inspections or establishing from the material's data sheet that it is resistant to specific chemicals.

6. The certificate number has an 'X' suffix that indicates that the following special condition of certification applies;
In the case of Pulsar REFLECT, due to the housing and labels being non-conductive plastic, care needs to be taken with regards electrostatic charge. The equipment shall not be installed if the conditions are conducive to the build-up of electrostatic charge. Additionally, the equipment should only be cleaned with a damp cloth.
7. The manufacturer should note that, on being put into service, the equipment must be accompanied by a translation of the instructions in the language or languages of the country in which the equipment is to be used and by the instructions in the original language.

Hazardous Area Specific Power Supply and barrier Requirements

The Pulsar REFLECT Intelligent transducer operates from a DC supply of 12 – 28V and will typically draw less than 22mA.

In the case of the Ex ia version the unit must be powered from an approved I.S. safety barrier or approved I.S. Power supply with the following limits: $U_i = <28V$, $I_i = <162mA$, $P_i = <0.85W$. $R_S \geq 250\Omega$

When installing in hazardous areas always check the label for approval details (see below):

EU/UK Label:

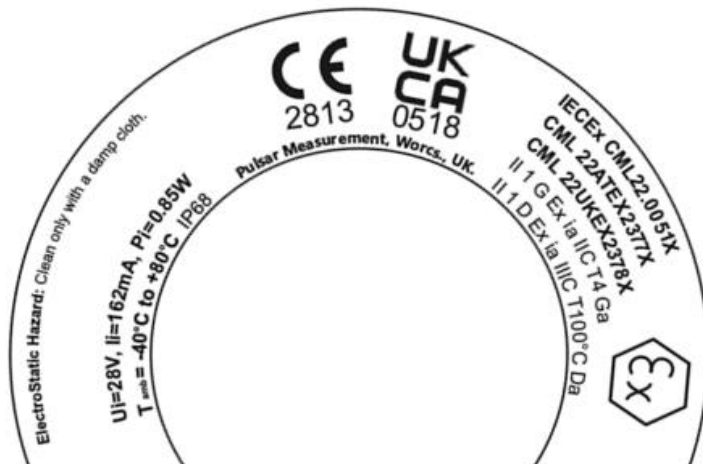

USA/Canada Label:



Hazardous Area Installation

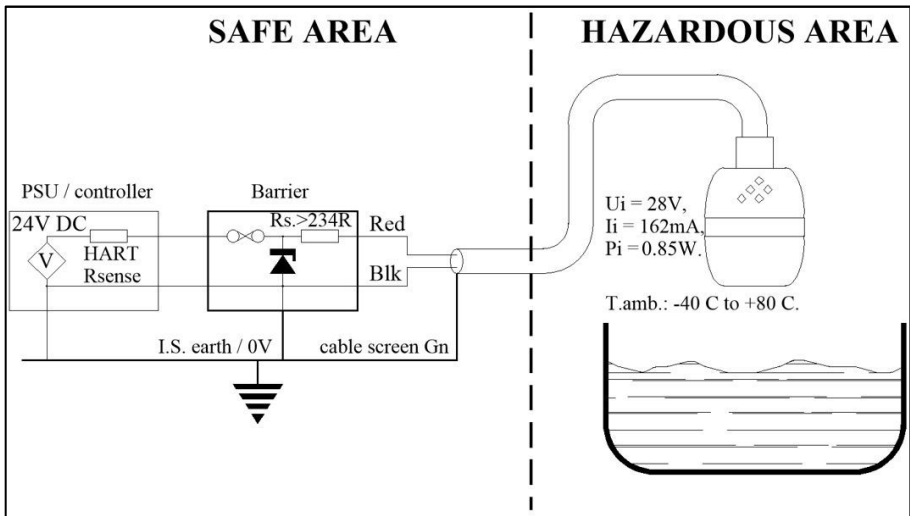

CABLE COLOUR	DESCRIPTION	COMMENTS
Red	DC Power +Ve	+ 12V to +28V DC max.
Black	DC 0V / Ground	Connect to the same point
Green	Cable Screen	

Important Notice

A Barrier with rated nominal resistance of $R_s \leq 250\Omega$ is advised for optimum performance.

FM Hazardous Area Installation

Reflect model:

The installation, including the barrier earthing arrangements, must comply with the requirements in the country of use; e.g. ANSI/ISA RP12.6 (Installation of Intrinsically Safe systems for hazardous / classified locations) and the National Electrical Code.

Power supply
28V DC max.
If an intrinsically safe power supply is used, a barrier is not needed.

HART modem

Data I/O (HART)

SAFE AREA

Reflect D-804-1420-B

Class I Div. I Group A, B, C & D, T4.
Class II Div. I Group E, F & G, T4.
Class III, T4.

Class I, Zone 0, AEx/Exia IIC T4 Ga.
Zone 20, AEx/Exia IIC T100°C Da.
T.amb.: -40 C to +80 C.

Electro-Static hazard:
Clean only with a damp cloth.

Danger Electro-Statique:
Nettoyer uniquement avec un chiffon humide.

Entity parameters:
Ui = 28V,
Ii = 162mA,
Pi = 0.85W.

Canada:
Installation must be in accordance with CEC part 1
The system must not be supplied from, nor contain, under normal or abnormal conditions, a source of potential with respect to earth exceeding 250V rms or 250V DC.
INSTALLATION MUST BE IN ACCORDANCE WITH THE MANUFACTURER'S GUIDELINES

Le Canada:
L'installation doit être conforme à CEC part 1.
Le système ne doit pas être alimenté par, ni contenir, dans des conditions normales ou anormales, une source de tension par rapport à la terre dépassant 250V rms ou 250V DC.
L'INSTALLATION DOIT ÊTRE CONFORME AUX DIRECTIVES DU FABRICANT.

CABLE COLOUR	DESCRIPTION	COMMENTS
Red	DC Power +Ve	+12V to +28V DC max.
Black	DC 0V / Ground	Connect to the same point
Green	Cable Screen	

Important Notice

A Barrier with rated nominal resistance of $R_s \leq 250\Omega$ is advised for optimum performance.

CHAPTER 3 HOW TO USE YOUR PULSAR REFLECT

4-20 mA Device

The REFLECT will be in Install-Liquid mode so will need to be changed to one of the measure modes to allow the output to be dynamic.

For example, if setting the measurement mode to **Level**, the 4 – 20mA output will be proportional to the **level** being seen, with respect to the maximum range and span of the REFLECT model being used as detailed in the table below.

	R 8	R 20
4 mA (Empty) 0% of Span Distance from the REFLECT Face in metres	8.00	20.00
20 mA (Full) 100% of Span Distance from the REFLECT Face in metres	0.075	0.075

Accessing Parameters

To view or change parameters values one of the following methods must be used:

Hart Commands

If familiar with the use of HART protocol and the Pulsar REFLECT Intelligent Transducer is connected to a HART modem, then it can be programmed following normal HART procedures.

Commands implemented by the Pulsar REFLECT Intelligent Transducer are as follows:

Universal

HART COMMAND	NAME	DESCRIPTION
0	Identity	Select short and long frame format to display sensor information.
1	Get Level	Obtains the current level of the dBi connected.
2	Get mA%	Obtains loop current reading and % of the range (Span).
3	Dynamic Variable Loop current	PV Loop mA = Loop current PV = Current level SV = Current Volume TV = Temperature QV = Serial Number
6	Set Poll Address	Used to set HART poll address of sensor.
7	Read Polling Address	Reads HART poll address of the sensor.
8	Read Dynamic Variable Classifications	Reads the classification associated with the dynamic variables.
9	Read Variables	Allows you to view up to 5 Device or Dynamic variables from the sensor.
11	Read Tag	Reads the identity about the sensor.

HART COMMAND	NAME	DESCRIPTION
12	Read Message	Reads the message contained in the sensor.
13	Read Tag	Reads the identity, descriptor and date of the sensor.
14	Read PV Information	Reads sensor serial number, measurement units, upper limit (100%), lower limit (0%) and minimum span.
15	Device Information	PV sensor information.
16	Read Number	Final assembly number associated with the sensor.
17	Write Message	Message used by the Master for record keeping.
18	Write Tag	Write the Tag, Descriptor and Date into the sensor.
19	Write Final Number	Write final assembly number to the sensor
20	Read Long Tag	Reads the 32-byte long tag information.
21	Read Tag	Reads the unique identifier information associated with the long tag.
22	Write Long Tag	Writes the 32-byte long tag to the sensor.
38	Reset Config Flag	Resets the configuration changed flag and returns the configuration counter.
48	More Status	Reads additional information.

Common practice

HART COMMAND	NAME	DESCRIPTION
33	Read Device Variables	This command allows you to read up to four device variables.
34	Write PV Damping	The damping value written by this command affects the PV transducers domain digital value.
35	Write PV values	Defines the relationship between the 4-20 points and the PV value.
40	Send Fixed Current	Places the sensor into a fixed current mode, with the loop current set to the required value.
41	Self Test	Initiates the self test function of the sensor.
45	Set 4mA	Trim the lower endpoint of the loop current (4mA).
46	Set 20mA	Trim the upper endpoint of the loop current (20mA).
47	Transfer Function	Selects the transfer function to be used between the loop current and the PV digital value.
83	Reset	Resets any loop current trim applied.
89	Set Time	This command is used to set the real time clock in the sensor.
90	Read Time	Reads the real time clock and current time as estimated by the sensor the last time the clock was set.

Pulsar REFLECT connection

Your Pulsar REFLECT Intelligent Transducer comes complete with the ability to connect to a Bluetooth html page (see [Chapter 4 – REFLECT Bluetooth and PC connectivity](#)). Or the free REFLECT HART Communicator Software, which, when used with a HART Modem, (see [Chapter 2 Installation](#) for full details on how to connect the modem), can be used to carry out the programming of the Pulsar REFLECT Intelligent Transducer.

Insert the USB which contains the software or download the software from the Pulsar website onto the PC intended to be used to carry out the programming of the Pulsar REFLECT Intelligent Transducer and install the software, following the on-screen instructions.

CHAPTER 4 REFLECT BLUETOOTH AND PC CONNECTIVITY

REFLECT Bluetooth

The Pulsar REFLECT Intelligent Transducer has the capability to connect to your smartphone (Android and Apple iOS), tablet or laptop via a Bluetooth connection. When connected you can view and change parameters, check level measurements, and view live echo traces in the palm of your hands.

For security reasons, the Bluetooth range may be reduced from 40m to as little as 4m or disabled altogether.

Important Notice

Bluetooth Requirements: Any device with Bluetooth 4.0 and above

PC: Chrome or Edge browser

Android: Chrome or Edge browser (**FREE**)

iOS: Download "Bluefy – Web BLE Browser" from App store (**FREE**), you will then need to type in the Web App address into the browser.

Connecting to Bluetooth

The Pulsar REFLECT Bluetooth software utilises a HTML page which can be used even when there is no internet connection available. There is no need for any modem or interconnecting cable, as the Pulsar REFLECT Intelligent Transducer can be setup when it is powered on and in situ in your application.

Enter <https://pulsarmeasurement.com/web-app/> into your browser as shown below, and press enter to search for the page. You can save this to your list of bookmarks so that you can easily connect to a Pulsar REFLECT Intelligent Transducer at any time.

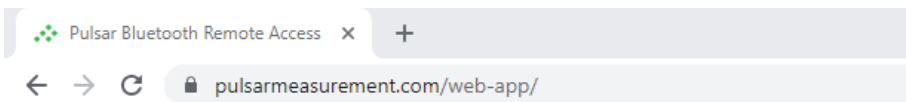

Important Notice

Ensure that the Pulsar REFLECT Intelligent Transducer is powered prior to making a connection to the REFLECT Bluetooth page

Alternatively, you can use the QR code provided below:



Whether using the QR code or the webpage App address, when selected you will be directed to the Pulsar REFLECT Bluetooth Home page where a connection to the Pulsar REFLECT can be made.

Important Notice

If using an iOS device, please scan the QR code and copy the URL link using your share button and paste to the BlueFy App to access the Web page.

Home Page

The Home page allows the connection/disconnection to a Pulsar REFLECT Intelligent Transducer, the ability to query and change parameters along with providing live information on the current readings obtained from the Pulsar REFLECT connected. This is carried out each time the user starts/restarts the trace, or when returning from the settings to either the home or trace page.

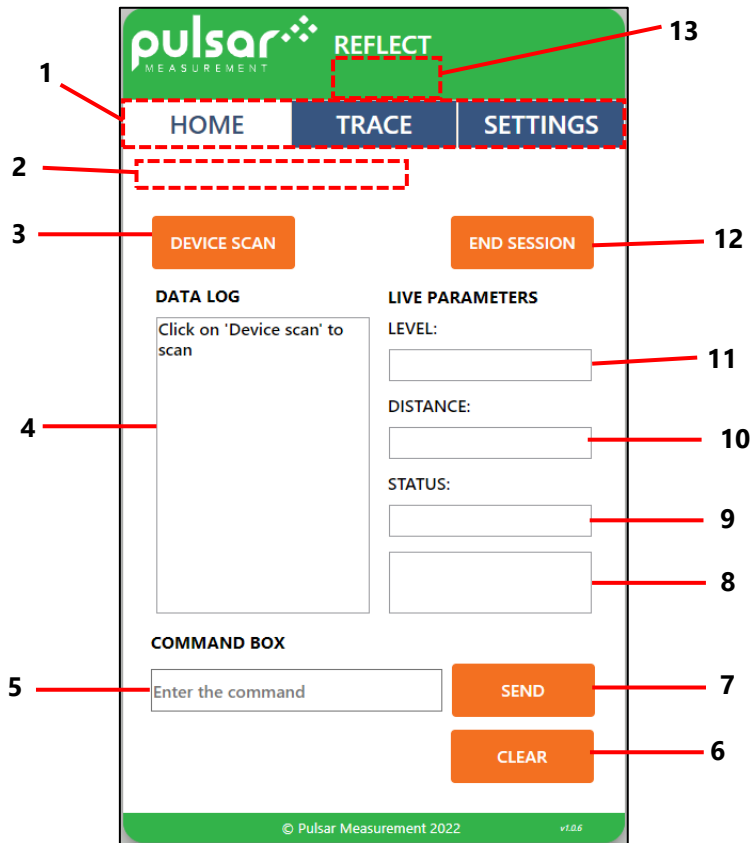

1. **Web Page Selector:** Displays the current Pulsar REFLECT page you are viewing highlighted by a white background.
2. **Update Information:** When a connection is made, update information for the echo trace will appear in this section here.
3. **Device Scan:** Click this to scan and pair to a Pulsar REFLECT Intelligent Transducer. Once selected, a window will open for you to select the Pulsar REFLECT you wish to pair via Bluetooth and connect to. When connected to a Pulsar REFLECT, the buttons on the Web App will change from Orange to Green, signifying a connection has been made successfully.
4. **Data Log:** This window displays a summary of the communication between the connected Pulsar REFLECT and the Bluetooth Web App. It also displays all parameter queries and changes that are made.
5. **Command Box:** The command box can be used to query and change value on parameters in the Pulsar REFLECT connected.
 - a. To query a parameter, you would type in **/Pxxx** (where 'xxx' is the parameter number) and then press Send. The current value will appear in the Data Log.

Example: If you wish to view what is set in P105 you would type the following: **/P105** And press Send, the information requested will then appear in the data log.
 - b. To change a parameter, you would type in **/Pxxx:n** (where 'xxx' is the parameter number and 'n' is the value you wish to change that parameter to).

Example: If you wish to change what is set in P105 you would type the following: **/P105:7** and press Send. The new value will then appear in the data log.
6. **Clear:** When selected this will clear all information shown in the Data Log window.
7. **Send:** When selected this will send any command that has been requested by the user to the Pulsar REFLECT connected.

- 8 **Live Parameter set:** Current Volume measurement (if setup to measure volume), Temperature and current output (in milliamps) are shown below the live status.
- 9 **Live Status:** This displays the status of the Pulsar REFLECT connected.
- 10 **Live Distance Measurement:** This displays the current **Distance** measurement being obtained from the Pulsar REFLECT connected.
- 11 **Live Level Measurement:** This displays the current **Level** measurement being obtained from the Pulsar REFLECT connected.
- 12 **End Session:** When this is selected, you will terminate the connection between the Web App and the Pulsar REFLECT you were connected to. To make a new connection, select Device Scan.
- 13 **Device Name:** If the Pulsar REFLECT connected has been given a unique Device name, it will appear here once a successful connection is made.

Connecting your REFLECT

Firstly, select the  button to begin scanning for your Pulsar REFLECT Intelligent Sensor.

A window will appear displaying the available Pulsar REFLECT Intelligent Transducers to connect to. Until the device name is changed, by default each Pulsar REFLECT is identified by the last 4 digits of its unique serial number. For example, if the Pulsar REFLECT you wish to connect to has a serial number of 352022, the Bluetooth pairing window will look like the below:

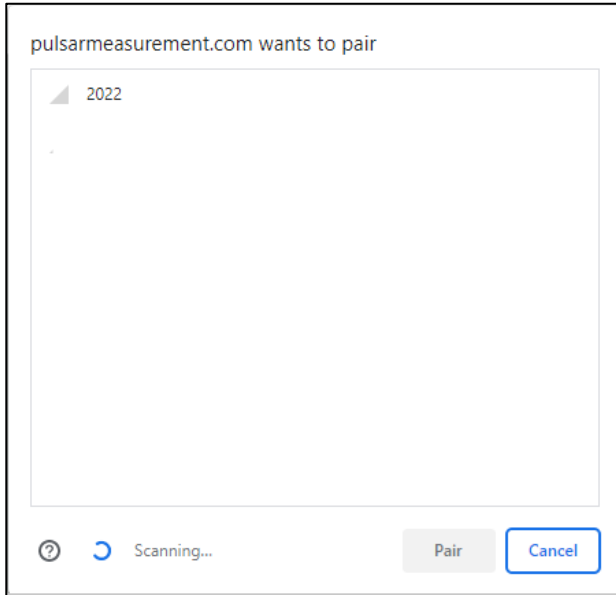

Select the Pulsar REFLECT you wish to connect to, and then press the Pair button which will now be highlighted in blue.

When connected, all the selectable buttons on the software will change from orange to green signifying a connection has been made. The command box will also display the message 'connected' and run through a quick diagnostic to ensure all is well with the sensor (which takes approx. 4 seconds).

When complete, the Web page App will automatically change to the Trace screen to allow you to view the live echo trace, level, distance, and status information from the Pulsar REFLECT connected.

Important Notice

If this is not the first time connecting to a sensor, a Bluetooth password may have been set. When 'pair' is selected, a prompt will appear to enter a password to allow access to the Pulsar REFLECT.

Trace Page

The Trace page provides real time echo trace readings, and status information on the current readings obtained from the Pulsar REFLECT connected.

You can also turn on/off the real time echo trace information on this page. This is the page that is displayed as soon as a confirmed connection has been made to a Pulsar REFLECT Intelligent Transducer.

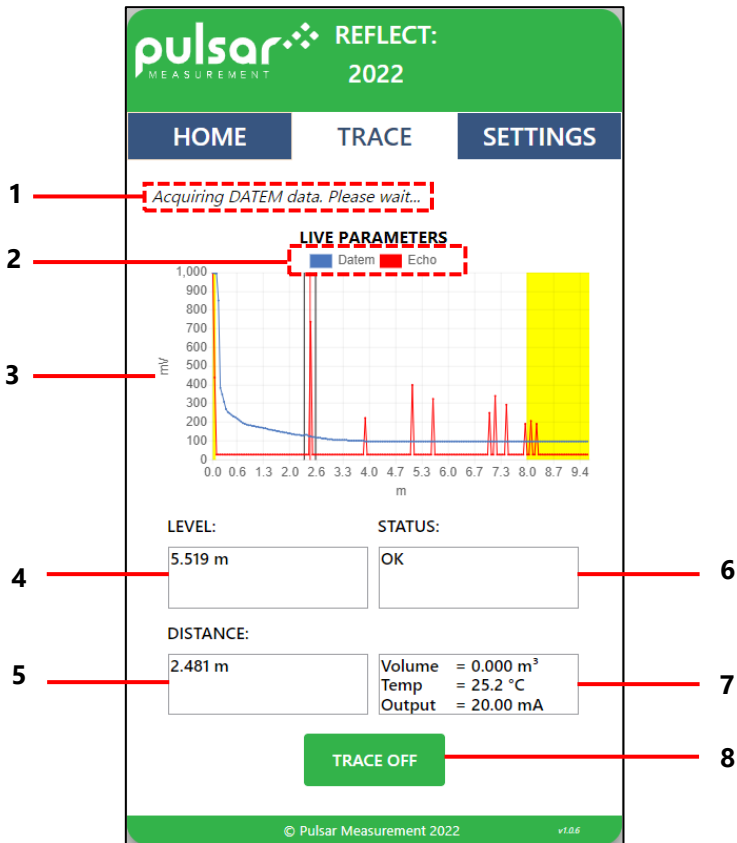

- 1. Update Information:** When the traces are being requested, update information for the echo trace will appear in this section here.

2. **Toggle DATEM and ECHO:** Option to view/hide DATEM and ECHO respectively by clicking on it.
3. **Trace area:** The graph area is used to display real time diagnostic echo trace information from the Pulsar REFLECT Intelligent Transducer connected.
The X axis represents the distance in measurement units (P104) defined by the Pulsar REFLECT transducer. The Y axis represents the signal strength in mV, on the status display this is represented as a percentage (0mV = 0% and 1,000mV = 100%).
Refer sections of [Raw Echo](#), [Gate and Measurement line](#), and [DATEM \(Digital Adaptive Tracking of Echo Movement\)](#) for detailed explanation on the echo trace data.
4. **Live Level Measurement:** This displays the current **Level** measurement being obtained from the Pulsar REFLECT connected.
5. **Live Distance Measurement:** This displays the current **Distance** measurement being obtained from the Pulsar REFLECT connected.
6. **Live Status:** This displays the status of the Pulsar REFLECT connected.
7. **Live Parameter set:** Current Volume measurement (if setup to measure volume), Temperature and current output (in milliamps) are shown below the live status.
8. **Trace On/Off:** Turns ON/OFF trace request sent to the connected REFLECT unit.

Settings Page

The setting page provides the user with options to view/update readily available Bluetooth and RADAR parameters. Once connected to a REFLECT unit, selecting the Settings page for the first time would do an initial query of all the RADAR parameters once.

pulsar REFLECT: 2022
MEASUREMENT

HOME TRACE **SETTINGS**

BLUETOOTH PARAMETERS

1 RANGE [40m]

2 DEVICE NAME UPDATE

3 PIN NUMBER UPDATE

RADAR PARAMETERS

Diagram: Tank with radar sensor (P107), measurement points (P106, P105, P108), and level indicators (0%, 100%).

4 INDICATOR MODE (P241) 7 = Health UPDATE

5 MEASUREMENT MODE (P100) 2 = Level UPDATE

6 MEASUREMENT UNITS (P104) 1 = m UPDATE

7 EMPTY DISTANCE (P105) 8.000 UPDATE

8 SPAN (P106) 7.925 UPDATE

9 FAIL MODE (P808) 1 = Hold UPDATE

10 VOLUME UNITS (P605) 0 = None UPDATE

11 SET DISTANCE (P21) 0.000 UPDATE

© Pulsar Measurement 2022

1. **Range:** Indicates the current Bluetooth range in metres. Also, allows the user to set the range between 4 and 40m using the slider. This could be used to prevent unauthorised access to the Pulsar REFLECT from outside the facility where it has been installed.
Note: The range is installation dependent and will be reduced by solid obstructions. A closed metal tank will greatly reduce the Bluetooth range.
2. **Device Name:** Displays the name of the connected REFLECT unit. Also, allows the user to set the name to any 4-digit alphanumeric character.

Important Notice

If the Bluetooth name of the REFLECT unit was changed, the user needs to reboot the unit and refresh the web app to see the changes.

3. **Pin Number:** Sets the password for the Bluetooth device. The user can enter the new password, which could have a maximum of up to 6 numeric characters.
4. **Indicator Mode (P241):** Gets/sets the indicator mode for the REFLECT unit. Refer [P241 Indicator Mode](#) for further information.



Important Notice

The user would see a warning message if the unit was running in any of the installation modes. This message appears only in the Settings page. It serves as a reminder to switch to the unit to the 'Health mode' (P241:7) after installation.

5. **Measurement Mode (P100):** Gets/sets the mode of operation for the REFLECT unit. Refer [P100 Mode of Operation](#) for further information.
6. **Measurement Units (P104):** Gets/sets the unit of measurement. Refer [P104 Measurement Units](#) for further details.
7. **Empty Distance (P105):** Gets/sets the empty level distance. Refer [P105 Empty Level](#) for further details.

8. **Span (P106):** Gets/sets the span of the unit. Refer [P106 Span](#) for further information.
9. **Fail Mode (P808):** Gets/sets the mA output in the event of the unit going into fail-safe mode. Refer [P808 Fail Mode](#) for detailed explanation.
10. **Volume Units (P605):** Gets/sets the unit used for the volume calculations. Refer [P605 Volume Units](#) for detailed explanation.
11. **Set Distance (P21):** Set the user defined echo to be selected as the correct target. Refer [P021 Set Dist.](#) for detailed information.

You will notice upon entering the Settings page, and when changing a value in the page, the buttons will change colour. The table below shows the different colours and what they mean:

COLOUR	DESCRIPTION
	A Pulsar REFLECT Intelligent Transducer is not currently connected.
	The Web App is doing an initial query of the setting, or a new value has been submitted for change by the user
	A Pulsar REFLECT Intelligent Transducer is connected. The change requested by the user has been accepted and stored into the connected Pulsar REFLECT Intelligent Transducer.

REFLECT Hart Communicator Software

The free Pulsar REFLECT Hart Communicator software is a powerful tool that is used to aid you in obtaining the most from your Pulsar REFLECT Intelligent Transducer. It can be downloaded for free from the Pulsar website:

<https://pulsarmeasurement.com/downloads/software/>

REFLECT Hart Communicator can be used to store all the parameters set in your REFLECT of your application. These can be saved to a PC and stored for future reference, or to clone a sensor. All parameters can be downloaded, viewed and if necessary, changed on a Pulsar REFLECT Intelligent Transducer via your laptop to suit your application.

REFLECT Hart Communicator software can also be used to record and view Echo Profiles from your applications, which can be saved for your records or sent via e-mail back to Pulsar Measurement for our engineers to analyse.

The software can also be used to re-program your REFLECT to the latest version of firmware, with any enhancements that it may contain. Please consult Pulsar Measurement for further information on re-programming your REFLECT if it is required.

Software Installation

When setting up your HART modem for the first use, you will need to install the necessary drivers for it to operate correctly with your OS. These drivers can be installed from the REFLECT Hart Communicator software installation package. Run the Pulsar REFLECT software .exe file from our website to install the Pulsar REFLECT Hart Communicator software correctly, this will automatically install the necessary drivers for your HART modem.

Important Notice

For optimum installation insert your HART modem to your PC whilst installing Pulsar REFLECT Hart Communicator software, where your PC should then assign the modem to a Com Port. Or if you have an internet connection, upon inserting the USB of the HART modem for the first time, Windows updates should install this onto your computer for you. Once the driver's installation has completed, remove the HART modem from your machine. Your modem is ready to be used when a connection to Pulsar REFLECT Hart Communicator software is required.

REFLECT HART connection

To connect to the Pulsar REFLECT Hart Communicator software, a HART modem is required to allow communication between the Hart Communicator software and the REFLECT transducer. When connecting to the software using the HART modem, power to the REFLECT transducer can be obtained from a 12-28V DC source.

Important Notice

Ensure that power to the sensor is switched 'OFF' before removing cables and any connection is made.

To allow the Pulsar REFLECT Intelligent Transducer to operate correctly, please ensure that the transducer is wired as shown in the picture below:

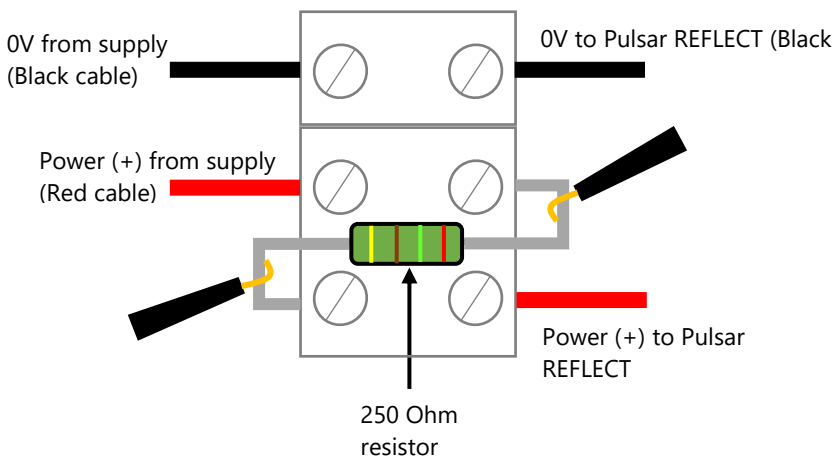

To enable the Pulsar REFLECT Intelligent Transducer to work correctly, the power (red) cables from the supply and to the REFLECT must be wired in series with the 250 Ohm resistor (as seen in the above picture).

Once the sensor is connected to the HART modem, insert the USB into the PC/laptop ready for use. You can now use Pulsar REFLECT Hart Communicator to make any change of settings to the REFLECT to suit your application.

Opening Pulsar REFLECT Hart Communicator

Once the Pulsar REFLECT Hart Communicator software has been installed on to your local machine, double click on the Pulsar REFLECT Hart Communicator shortcut and a window will appear prompting you to enter a passcode (like the image shown below).

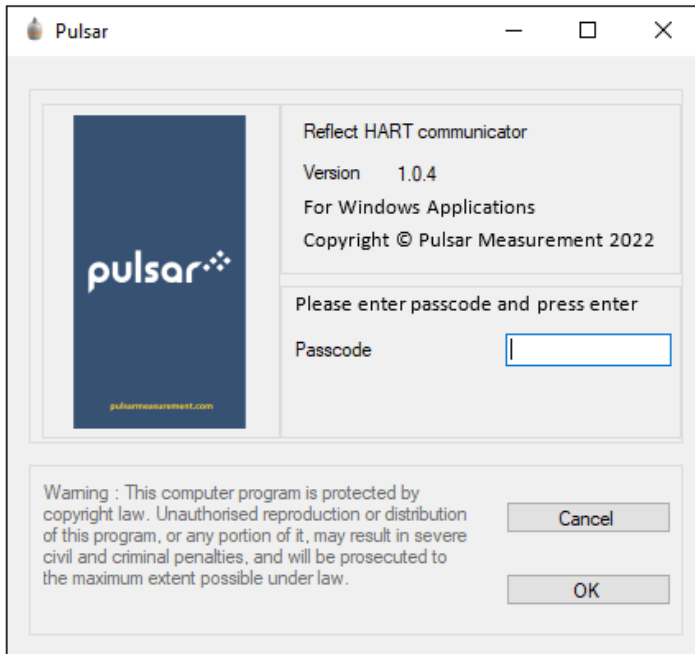

The password to enter REFLECT Hart Communicator software is **1997**, once typed in press enter and the software will open and be ready for use.

Pulsar REFLECT Hart Communicator Opening Screen

Menu Strip

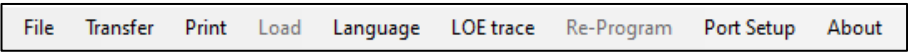

Shortcut Icons

Main screen selection tabs



Main Screen

Toggle parameter list



Menu Strip

Common Controls

None of the menu strip drop down menus can be accessed if you are viewing echo profiles. To access these menu options, change regular echo to 'Off'.

File

Selecting this drop-down menu will give you the option of opening a previously stored parameter file, echo file or saving parameters to file

Transfer

The **Transfer** menu enables you to do the following:

Get parameters from unit: Once uploaded to the software from the Pulsar REFLECT, you will be asked to save the parameters as file name and location on your PC of your choosing.

Send parameters to the unit: Send all parameters currently loaded on the Pulsar REFLECT Hart Communicator software.

Single Parameter programming: This is where you can view and/or change a parameter one at a time.

Print

The **Print** menu enables you to do the following:

Save trace to file: A screenshot is saved of the echo currently displayed to a file name and location on your PC, and then copyable into a document.

Print trace: Prints a copy of the trace currently viewed to your printer.

Print parameters: Allows you to print a complete list of all the parameters that are accessible in the Pulsar REFLECT.

Print changed parameters: Allows you to print a list of only the parameters that have been modified from their default values in the Pulsar REFLECT.

Re-program

The re-program option will be greyed out as this requires service access; this will allow you to re-program the Pulsar REFLECT with up-to-date firmware. Please consult Pulsar Measurement for assistance in carrying out this operation.



Setup





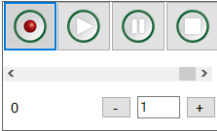
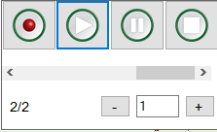
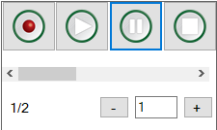

The **Setup** menu enables you to open the Comport settings window, enabling you to select the comport that the Pulsar REFLECT is connected to. Please consult Pulsar Measurement if you wish to utilise the Re-program option which is greyed out.

About

This displays information about the Pulsar REFLECT software you are using.

Shortcut Icons

NAME	ICON	DESCRIPTION
File		Allows you to search for any parameter file that you wish to open, view, and examine. Parameter files are saved in a .xml format.
Save to Clipboard		Selecting this icon will paste the current viewed echo profile onto your clipboard, from there it can be pasted into a document such as word for recording, viewing, or reporting.
Record & Playback		<p>When selected, a window will appear with 4 buttons to select from. Record, play, pause and stop. The button that has been selected will be highlighted by a blue border.</p> <div data-bbox="445 606 660 737">  <p>Recording a trace</p> </div> <p>When recording an echo trace, you will first be prompted to save the echo recording on to your PC. When done, the record button and status bar will turn red, indicating that recording is underway. When finished, select the record button again to stop.</p> <div data-bbox="445 906 660 1037">  <p>Replaying a trace</p> </div> <p>To replay a saved echo trace, select the play button and choose the relevant echo file (.hir) to replay. The play button will be highlighted by a blue border to indicate that an echo is being replayed.</p> <div data-bbox="445 1181 660 1311">  <p>Playback Controls</p> </div> <p>You can also pause and move the slider to a specific position of the total trace recordings (ideal for long recordings). Or press stop to end the replay.</p>

NAME	ICON	DESCRIPTION
Upload		This enables you to download all parameters that are currently in the Pulsar REFLECT that is connected to the Hart Communicator software. You will be prompted to save the parameters when the download is complete.
Send Parameters to Unit		This allows you to send all parameters at once in the PC software to the Pulsar REFLECT that is connected.
Single Programming		This enables you to program one parameter at a time. Press the single programming icon and, when the Interactive Programming display window appears, press the connector icon, this will connect your PC to Pulsar REFLECT. Key in the parameter number required and press the read key. Change the value to the required amount and press send, the change is then verified. Note: Pressing the Hard Default or Factory Default icons will restore factory parameters to your unit and information will be lost if not previously saved.
Status Display		Selecting this icon enables a small list of information about the performance of the unit. This includes Level, Distance, Volume, Temperature, Noise, Strength, and Status.
System Information		This enables you to view the current firmware version, Hardware version and serial number of the Pulsar REFLECT connected to the Hart Communicator software.
Exit		Selecting this will exit your current session from the Hart Communicator software. Please ensure any unsaved parameters are uploaded to the Pulsar REFLECT prior to selecting this option.

Toggle Parameter List

When you have uploaded the parameters from the connected REFLECT (or from your laptop), a list of changed parameters will appear in the right-hand side of your screen.

Pressing the toggle parameters icon  will alternately show all parameters, (with the changed parameters highlighted in yellow), show only the changed parameters, and then hide the table from view.

Main Screen Selection Tabs

Echo

This provides a graph and controls for viewing diagnostic echo traces.

HART Commands

This provides access to generic common parameters that are common to all HART compatible devices.

Parameters

The Pulsar REFLECT Intelligent parameters can be viewed in a table format, and in relational groups. Hovering your cursor over the parameter value boxes will allow you to view the information that can be selected for that specific parameter.

For further information on the parameters available in each section and their options, please refer to [Chapter 5 Parameter Guide](#).

Volume

This tab is available when the measurement mode (P100) is set to Volume (option 4). This allows simple parameter setup of a vessel shape and its dimensions, or alternatively the setup of a pre-determined 16-point level/volume breakpoint table.

Main Screen

The main screen is used to display real time diagnostic echo trace information from the Pulsar REFLECT Intelligent Transducer connected or replay recorded echo traces previously saved.

Echo traces

To request an echo trace from the Pulsar REFLECT, select the Regular Echo 'On' button, this will turn on and an echo will then be presented on the main screen.

The X axis represents the **distance** in **measurement units (P104)** defined by the Pulsar REFLECT transducer. The Y axis represents the **signal strength** in mV, on the status display this is represented as a percentage (0mV = 0% and 1,000mV = 100%). Example of an echo trace is shown below:

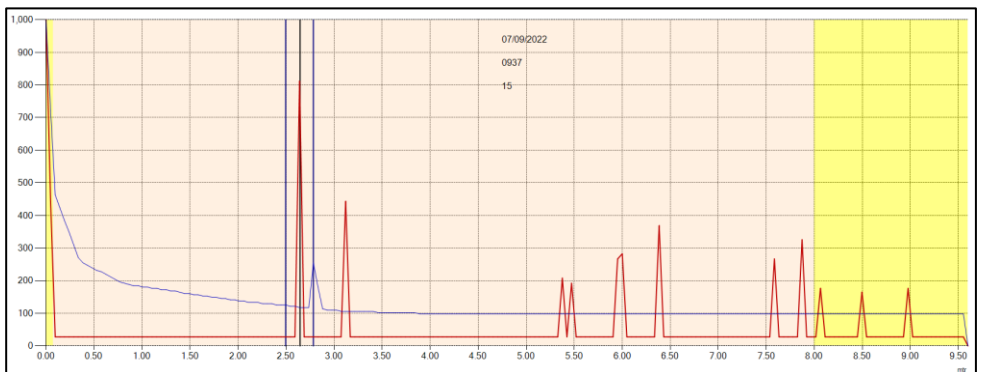

Raw Echo

The Raw echo is shown in red. It shows signals (echoes) reflected from objects as peaks in the trace.

The higher the peak of the echo, the stronger the echo is. The far-left portion of the raw echo trace is known as the ringdown. The ringdown region is the reason for the near blanking dead band. As a target moves further away from the transducer, the signal strength of the returned echo will reduce.

Gate and Measurement line

The distance line shows which echo is being selected for the measurement. The vertical blue lines remain fixed at either side of the distance line, and act as a stability mechanism to filter out any momentary echoes from passing machinery/stirrers etc.

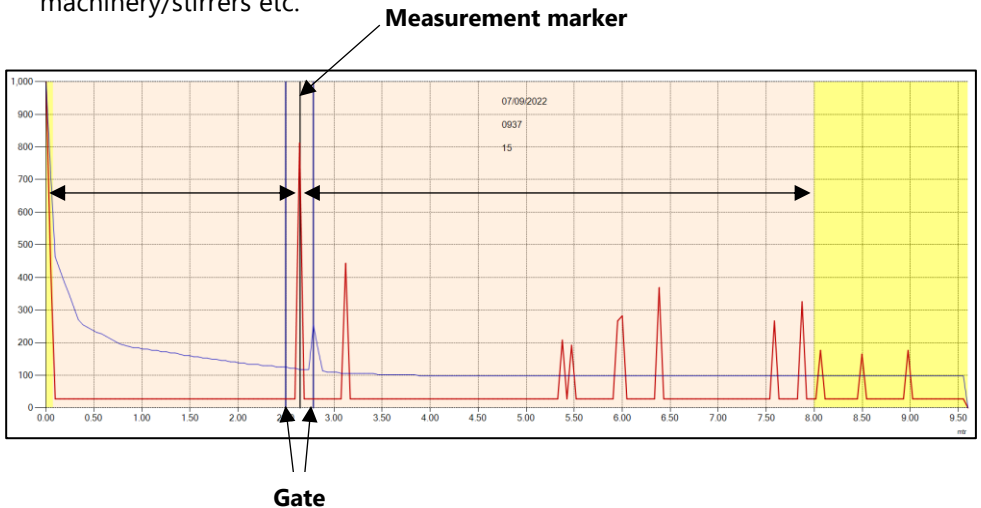

DATEM (Digital Adaptive Tracking of Echo Movement)

The (blue) DATEM trace acts as a threshold which defines if echoes are considered as candidates for measurement. Any echo whose peak is below the DATEM line, will not be considered for measurement. In effect the transducer will not "see" it.

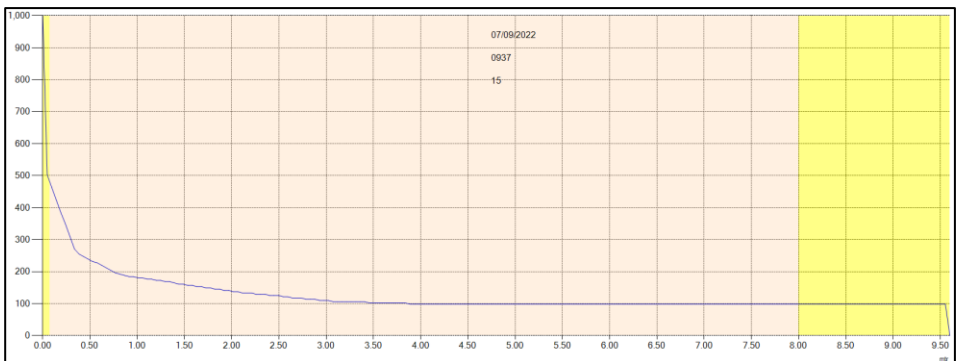

By default, the DATEM in Pulsar REFLECT Transducers is ACTIVE which means it will grow to cover (mask out) any fixed obstructions in front of the current measurement echo.

Looking at the trace below, the only echo which can be "seen" by the echo selection algorithm is the current selected echo at 2.6 metres.

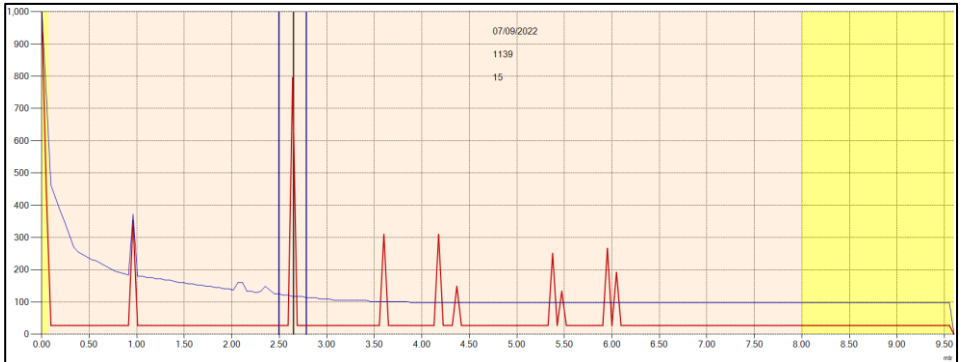

Zooming

You can zoom into an echo trace by clicking and dragging a window from Top Left to Bottom Right across the area you want to zoom into.

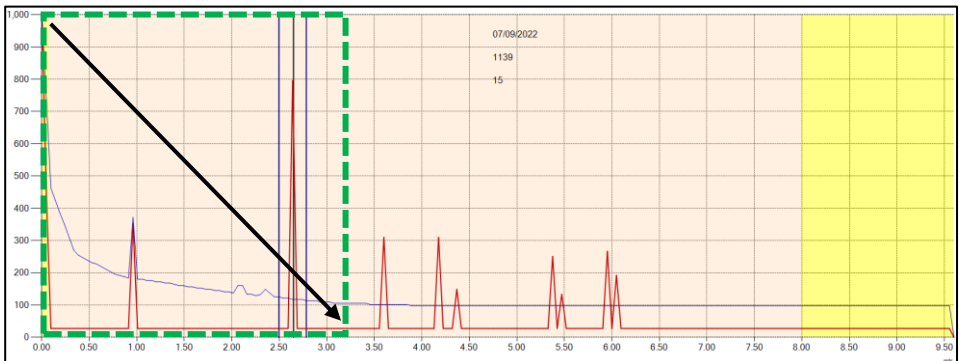

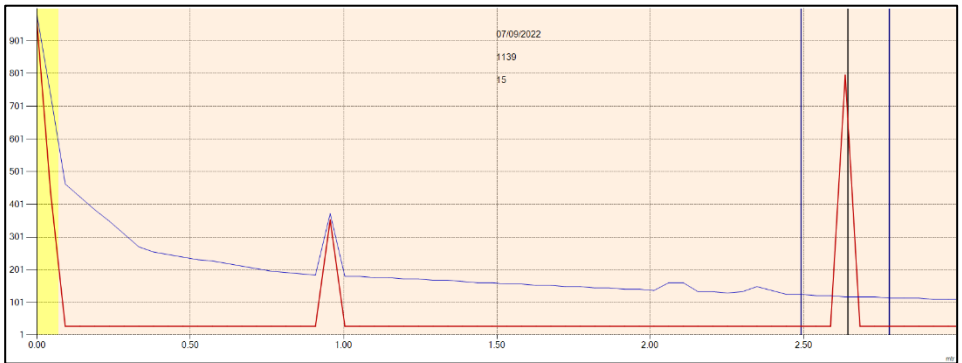

To zoom out, simply draw a box from the bottom right to top left and the echo trace will resume its normal shape.

Important Information

If you are connecting to multiple devices that are to be placed onto a HART network, the Poll address of each sensor will need to be changed from the default value of 0. Please use HART command 6 (Set polling address) to change the address of each sensor.

Common Parameters

This section of the screen is always visible and has controls for scanning and connecting to Pulsar REFLECT Intelligent Transducers, obtaining echoes, manipulating DATEM, progress bar indication and cursor positioning on the echo screen.

Status

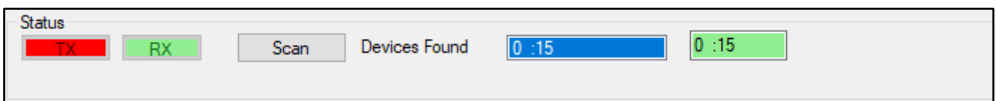

From the left of the status section, the transmit (TX) and receive data (RX) from the Pulsar REFLECT Intelligent Transducer, when it is communicating with the PC software. They will flash red/green when communication is being made.

After using the Setup menu option to detect the correct comport, you can look to make a connection the connected Pulsar REFLECT Intelligent Transducer.

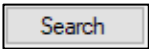
Click on the  button to begin a scan of any connected HART devices. The poll address and serial number of any device(s) found will appear in the white box '**Device Found**'.

Click on the white box of the serial number of the Pulsar REFLECT you are looking to communicate with. The white box will change to blue, and the adjacent box will be highlighted as green with the poll address and serial number of the connected Pulsar REFLECT (as shown in the example below).

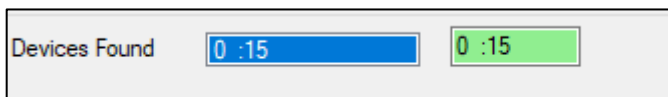

Once a connection is made successfully, the buttons in common controls section will become active, except for 'view DITEM points' and 'Update points' as this is a service level access feature.

Trace

To request echo traces from the Pulsar REFLECT Intelligent Transducer, change regular echo from Off:

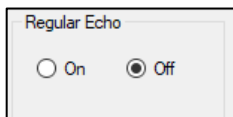

To On:

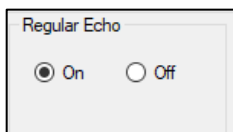

When the regular echo is turned on, the regular echo selection box will highlight red indicating a trace is being obtained and displayed. When obtaining a trace for the first time it will take approx. 7 seconds to retrieve the information, after this the trace will continue to display live information from the Pulsar REFLECT every 2 seconds.

*DATEM***Important Information**

This feature is only available when in service mode. Please consult a Pulsar Measurement engineer for further assistance.

The DATEM line can be adjusted manually, by selecting the 'view DATEM points' box. When selected a purple line will appear on the echo trace graph with a number of moveable points, as shown in the example below:

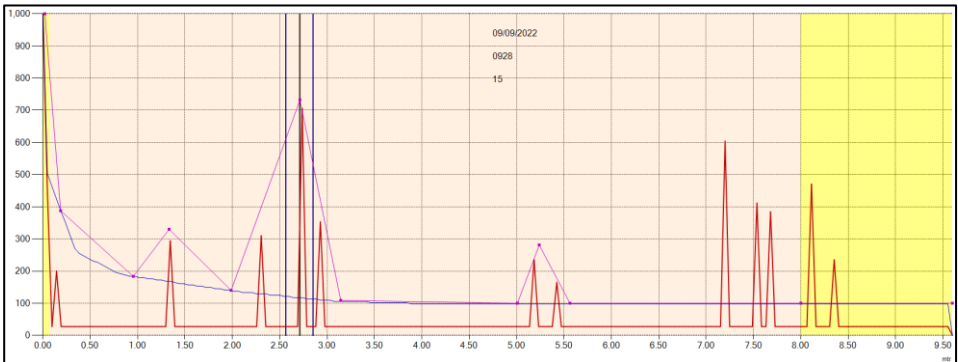

The points can be clicked on and dragged in order to manipulate the DATEM line to cover any unwanted echoes you want to hide from the echo selection algorithm. Once the line is in its final position, click the

Update points

button and the new values will be transferred to the real time DATEM line, and the echo will change like the example below:

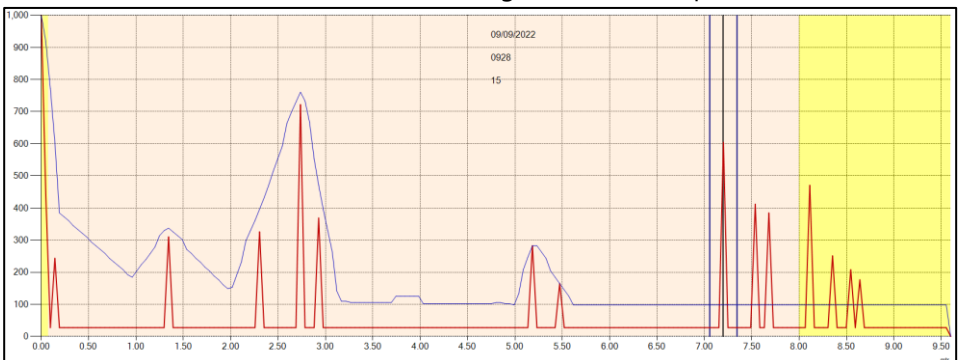

Default

To undo the manipulation of the DATEM points, select the button and the DATEM line will resume its default value:

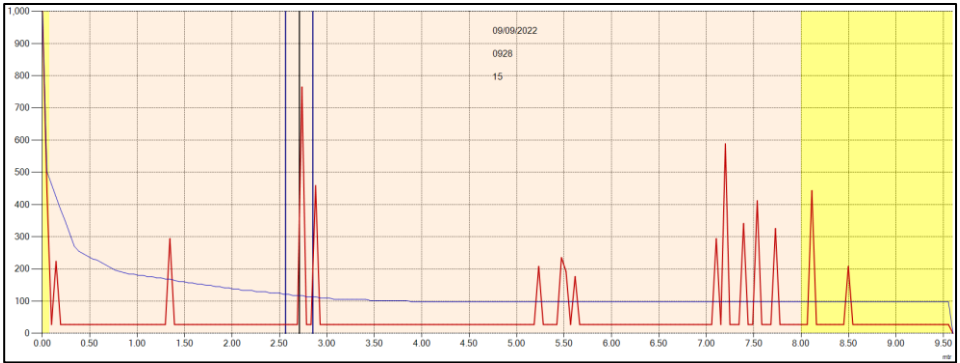

P21 DATEM Distance

Datem Distance P21

To request echo traces from the Pulsar REFLECT Intelligent Transducer, change regular echo from Off:

This parameter allows you to determine which echo is to be used for measurement purposes. On start-up, if the Pulsar REFLECT is showing an incorrect reading, then simply enter the distance from the transducer face to the required material level and, if an echo is present at this point, the Gate will establish itself around the chosen echo. DATEM will update in front of the Gate and reference out any other unwanted echoes.

It should be noted that DATEM will reset to default values whilst performing this function, and reform itself once it has selected an echo.

Enter distance from the face of transducer to the target in **Measurement Units (P104)**.

Datem Distance P21

Enter the value of the distance measurement (in **Measurement Units (P104)**) into the white box

Press the Update button, to lock on to the selected echo. Update button will be highlighted as green to signify the change is taking place and when complete it will return to grey. Press 'On' to obtain a new echo trace and the value in the white box will return to 0.

Progress Bar

The progress bar color changes to indicate the different actions that are being performed.

Blue indicates that the raw echo is being obtained and updated when it reaches 100%.

Purple indicates that the DATEM line is being obtained and updated when it reaches 100%.

Red indicates that the trace information is being recorded and the file updated when it reaches 100%.

Cursor Position

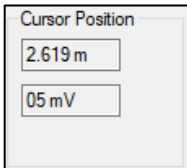

A screenshot of a software dialog box titled "Cursor Position". It contains two input fields. The first field displays the value "2.619 m" and the second field displays "05 mV".

When hovering the mouse pointer on the echo trace graph, the pointer position will be updated in the **Measurement Units (P104)** and mV in the cursor position value boxes.

Transducer

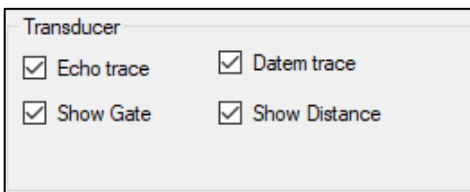

A screenshot of a software dialog box titled "Transducer". It contains four checked checkboxes arranged in a 2x2 grid: "Echo trace", "Datem trace", "Show Gate", and "Show Distance".

Echo Trace

This option displays the Raw echo when selected, if unselected the Raw echo will be hidden from view on the echo trace graph.

Show Gate

This option displays the Gate when selected, if unselected the Gate will be hidden from view on the echo trace graph.

DATEM Trace

This option displays the DATEM line when selected, if unselected then DATEM will be hidden from view on the echo trace graph.

Show Distance

This option displays the Measurement Marker line when selected, if unselected the Measurement Marker will be hidden from view on the echo trace graph.

Quick start setup

This section explains how to undertake functions of your Pulsar REFLECT Intelligent Transducer to quickly set up the transducer for a basic level measurement. Where specific parameters are used, consult [Chapter 5 Parameter Listing and Description](#).

Setting up Your Application

Empty Distance

Empty Distance (P105) is the distance from the face of the transducer to the material at the bottom of the vessel.

Important Information

When using a front thread adaptor, the empty distance measured from the face of the adaptor to the material being measured requires an offset of 38mm (1.5"). To perform this offset, use P851 (measurement offset) and set the value of this parameter to -38mm (-1.5").

Span

Span (P106) is the distance from the empty level (0% full) to span (100% full).

Near and Far Blanking

Near blanking (P107) is the distance from the face of the transducer that the Pulsar REFLECT Intelligent Transducer will not record a level nearer than. A typical reason to increase this from the default value would be if you wish to ignore close in obstructions.

Far blanking (P108) is the distance (as a percentage of empty level) beyond the empty level that the Pulsar REFLECT Intelligent Transducer will read, the

default is plus 20% of empty level. If you wish to monitor further than the **empty level**, then increase this figure, so that the **empty level** plus the **far blanking** figure (as % of empty level) is greater than the surface being measured, within the capability of the transducer being used.

Using the 4-20 mA Output

The mA output can be used to monitor remotely what the Pulsar REFLECT Intelligent Transducer is measuring, so it can be displayed remotely, integrated into a PLC, or used to generate a record using a chart recorder or similar.

By default, the Pulsar REFLECT Intelligent Transducer will provide a 4-20 mA output that is proportional to **level** and can be overwritten as follows:

By default, the 4-20 mA will represent the operational span of the Pulsar REFLECT model in use, with empty (0% full) = 4mA and full (100% of the operational span) = 20mA, but you may wish to only represent a section of the operational span. For example, the application may have an operational span of 6 metres, but you may only wish to represent empty level to 5 metres. If so, change **P834 (Low Value)** to **0**, and **P835 (High Value)** to **5.0**.

If the device connected to the mA output is out of calibration, and cannot be calibrated, then the low and high current levels can be trimmed by altered in the HART Command tab **P838 (Low Trim)** and **P839 (High Trim)**. To do this, simply enter the value that ensures that 4 mA or 20 mA respectively are shown on the remote device.

Setting Security Passcodes

A passcode is used to protect parameter entries and will be required when accessing parameters with certain PC Software's. You can set a new passcode to prevent anyone changing any of your settings within your Pulsar REFLECT Intelligent Transducer. The default **passcode** is **1997**, but this may be changed as follows.

Important Notice

The passcode is also used for remote access using certain PC Software's or the Bluetooth, so if this is being used, be sure to ensure any additional equipment using this feature is changed accordingly.

Resetting Factory Defaults

If you need to restore parameters to their original factory settings, then access parameter P930, which is the factory defaults parameter, change the value to 1 and ENTER, all parameters, except for the mA trims, will be restored to the factory settings (including the DATEM trace) and on completion.

Checking the Software Revision and Serial Number

If you need to identify the serial number of the unit or the current level of software in your Pulsar REFLECT Intelligent Transducer, the following parameters can be used. Select parameter **P926** to view the identity of the current software **revision** or **P928** for the **serial number** of the unit.

CHAPTER 5 PARAMETER LISTING AND DESCRIPTION

Application

Operation

P100 Mode of Operation

This parameter sets the mode of operation, when in run mode, and can be set to one of the following:

OPTION	DESCRIPTION
1= Distance	Display shows the distance from the transducer face to the surface.
2= Level (Default)	Display shows how full the vessel is.
3= Space	Display shows how empty a vessel is.
4= Volume	Display shows volume of material in the vessel

P102 Material

This parameter should be set to the type of material being monitored.

OPTION	DESCRIPTION
1 = Liquid (Default)	Use for liquids and flat solid materials
2 = Solid	Solid material that is heaped or at an angle
3 = Closed Tank	Use for closed tanks or domed roofs.

P241 Indicator Mode

This parameter should be set to the type of material being monitored. The below outlines what each indicator mode does:

MODE (P241)	DESCRIPTION	FUNCTION	MA OUTPUT
0	OFF	Any	Dynamic
1 (As shipped)	Installation – Liquid	Long LED Flash, colors related to Tilt Angle of installation.	20mA Fixed
2	Installation – Solid	Long LED Flash, colors related to signal strength	20mA Fixed
4	Measurement – Liquid	Short LED Flash, colors related to Tilt Angle of material being measured.	Dynamic
5	Measurement – Solid	Short LED Flash, colors related to Average signal strength.	Dynamic
7 (Default)	Health	Short LED Flash, Indicator follows NAMUR standard for self-monitoring and diagnostics of field devices.	Dynamic

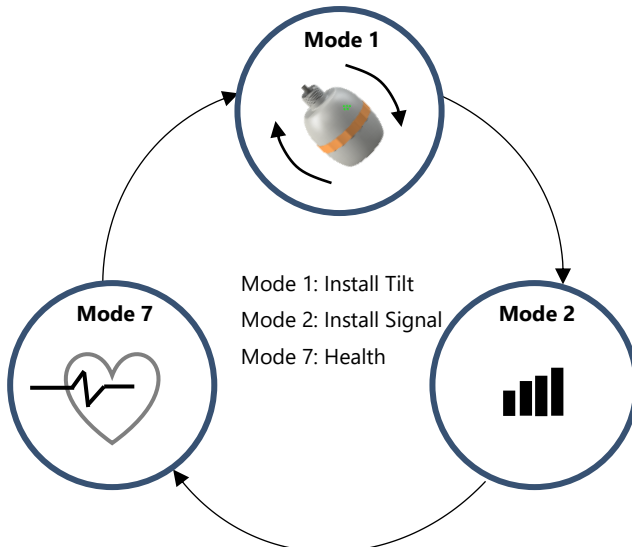

LED Functionality

MODE NUMBER (P241)	LED FUNCTION		
	GREEN	AMBER	RED
0	OFF	OFF	OFF
1	Level with Horizontal plane	Between Pass and Fail	Not Level
2	Raw Echo Strength above P242 (Signal Strength Threshold 1)	Raw Echo Strength above P243 (Signal Strength Threshold 2)	Raw Echo Strength below both thresholds
4	Level with Horizontal plane	Between Pass and Fail	Not Level
5	Averaged Echo Strength above P242 (Signal Strength Threshold 1)	Averaged Echo Strength above P243 (Signal Strength Threshold 2)	Averaged Echo Strength below both thresholds
7	Refer to table provided below		

Health Indicator Mode

HEALTH INDICATOR MODE			
CRITICAL (RED)	WARNING (AMBER)	MAINTENANCE (BLUE)	HEALTHY (GREEN)
Echo loss			
Temperature Limit			
Voltage Limit			
Alarm flag	Measurement is outside of the gate	Accelerometer not calibrated.	Operating normally
RADAR unresponsive for 5 times			
Ping timeout (45s)			

Distance

P104 Measurement Units

This parameter sets the units you want to use for programming and display

OPTION	DESCRIPTION
1 = metres	All units of measure are METRES
2 = cm	All units of measure are CENTIMETRES
3 = mm	All units of measure are MILLIMETRES
4 = feet	All units of measure are FEET
5 = inches	All units of measure are INCHES

P105 Empty Level

This parameter is to be set to the maximum distance from the face of the transducer to the empty point, in **P104 Measurement Units**. Note this value affects span as well, so should be set before span. **Default: R8 = 8.00m (26.24 feet), R20 = 20.00m (65.61 feet)**.

P106 Span

This parameter should be set to the maximum distance from the **Empty Level (P105)** to the maximum material level. By default, when first powering up the REFLECT this is equal to the **Empty Level (P105)** less the **Near Blanking** distance (**P107**) when you set the empty level. **Default R8 = 7.925m (26 feet), R20 = 19.925m (65.37 feet)**.

P107 Near Blanking

This parameter is the distance from the face of the transducer that is not measurable and is pre-set to the minimum value dependant on the version of Pulsar REFLECT Intelligent Transducer being used. It should not be set to less than this figure but can be increased.

REFLECT VERSION	NEAR BLANKING DISTANCE
R8 (up to 8 metres)	Default Blanking Distance = 0.075m (0.24 feet)
R20 (up to 20 metres)	Default Blanking Distance = 0.075m (0.24 feet)

P108 Far Blanking

This is the distance (as a **percentage** of empty level) beyond the empty point that the unit will be able to measure, and the **default** is pre-set to **10%** of the empty level.

If the surface being monitored can extend beyond the **Empty Level (P105)** then the far blanking distance can be increased to a maximum of 100% of empty level.

This parameter is always entered as a % of empty level.

Data Logs

The data log parameters contain the following information:

Temperature

The following parameters give information on temperature conditions seen by the **Temperature source (P852)** in °C. These parameters are read only and cannot be changed, though if P852 is changed they will be reset.

P580 Minimum Temperature

This parameter displays the minimum temperature recorded.

P581 Minimum Temperature Date

This parameter displays the date when the minimum temperature was recorded.

P582 Minimum Temperature Time

This parameter displays the time when the minimum temperature was recorded.

P583 Maximum Temperature

This parameter displays the maximum temperature recorded.

P584 Maximum Temperature Date

This parameter displays the date when the maximum temperature was recorded.

P585 Maximum Temperature Time

This parameter displays the time when the maximum temperature was recorded.

P586 Current Temperature

This parameter displays the current temperature.

Transducer Power Information

The following parameters provide information on when the Pulsar REFLECT Intelligent Transducer was last powered down and how long it had run for.

P940 Number of Starts

This parameter displays the number of times that the unit has been powered since leaving the factory.

P941 Last Power Off Date

This parameter displays the last date on which the power was removed from the unit.

P942 Last Power Off Time

This parameter displays the last time on which the power was removed from the unit.

P943 Last Run Time (minutes)

This parameter displays how long the unit had been running, in minutes, prior to the last power down.

P944 Last Run Time (hours)

This parameter displays how long the unit had been running, in hours, prior to the last power down.

mA Output

P834 mA Low Level

This parameter sets the level, distance, or space, at which the low mA output will occur (4mA). **Default = 0.000m**

P835 mA High Level

This parameter sets the level, distance, or space, at which the low mA output will occur (20mA). **Default = 8.000m (R8), 20.000m (R20)**

P838 Low Trim

If the Pulsar REFLECT you are connected to is not calibrated, and not showing the correct low value (4mA reading), then you can trim it using this parameter, by typing in the offset directly.

P839 High Trim

If the Pulsar REFLECT you are connected to is not calibrated, and not showing the correct high value (20mA reading), then you can trim it using this parameter, by typing in the offset directly.

Important Notice

It is advised to trim the Pulsar REFLECT Intelligent Transducer using the HART Command 4-20mA. This allows you to force a mA output to better trim the Pulsar REFLECT.

*mA Failsafe**P808 Fail Mode*

This parameter determines what happens to the mA output in the event of the unit going into fail-safe mode:

OPTION	DESCRIPTION
1 = Hold (Default)	The Pulsar REFLECT will Hold its last known value
2 = High	The Pulsar REFLECT will read High (20mA)
3 = Low	The Pulsar REFLECT will read Low (4mA)
4 = 22mA	The Pulsar REFLECT will output 22mA
5 = 3.8mA	The Pulsar REFLECT will output 3.8mA

P809 Fail Time

In the event of a failsafe condition the failsafe timer determines the time before a failsafe mode (**P808**) is activated. **Default = 2mins.**

Compensation*P851 Measurement Offset*

The value of this parameter is added to the measured distance, in **Measurement Units (P104)**.

This Offset will be added to the level, as derived from the Pulsar REFLECT Intelligent Transducer, and will affect everything including the reading on the echo display, and the mA output.

P852 Temperature Source

This parameter determines the source of the temperature measurement. By **default**, it is set to automatic (**Option 1**), which will automatically detect if a temperature sensor is available from the Pulsar REFLECT. If for any reason, no temperature input is received, then the **Fixed Temp** value is used, as set by **P854**.

The temperature source can be specifically set as follows:

OPTION	DESCRIPTION
1 = Automatic (Default)	Will automatically select transducer temperature sensor, if available, or fixed temperature (P854) if no temperature sensor found.
2 = Xducer	Always uses temperature reading from Pulsar REFLECT Intelligent Transducer
3 = Fixed	Always uses fixed temperature as set in P854

P854 Fixed Temperature

This parameter sets the temperature, in degrees centigrade to be used if **P852 = 3. Default = 20°C.**

Stability

Damping

Damping is used to damp the reading, to enable it to keep up with the process but ignore minor surface fluctuations.

P870 Fill Damping

This parameter determines the maximum rate at which the unit will respond to an increase in level. It should be set slightly higher than the maximum vessel fill rate. **Default = 10.000 metres/minute (32.81 feet/minute)**

P871 Empty Damping

This parameter determines the maximum rate at which the unit will respond to a decrease in level. It should be set slightly higher than the maximum vessel empty rate. **Default = 10.000 metres/minute (32.81 feet/minute)**

Filters

P881 Fixed Distance

This parameter determines the width of gate to be used in tracking an echo and under normal circumstances will not require changing, but it can be increased in the cases where the surface is moving extremely fast (more than 10m/min) to ensure smooth processing of the changing level.

P884 Peak Percentage

When **P102 = 2 (Solids)**, this parameter can be used to determine the point at which the measurement is taken, within the established gate of the selected echo, to compensate for any error that maybe caused by "angles of repose" presented by the way the material settles. Please consult Pulsar, for further information and assistance on changing the value of this parameter.

System

Important Notice

Parameters 926, 927 and 928 do not affect how the unit performs, but details contained in them may be required, by Pulsar Measurement, when making technical enquiries.

System Information

P926 Software Revision

This parameter will display the current software revision.

P927 Hardware Revision

This parameter will display the current hardware revision. It is read only and cannot be changed.

P928 Serial Number

This parameter will display the serial number of the Pulsar REFLECT connected.

Default

P930 Factory Defaults

This parameter resets all parameter values to the original Factory Set values that were installed when the unit was tested before despatch to you.

To **reset** parameters, Set P930 to 1.

Date & Time

The date and time are used, to stamp certain events that are contained in the Data Logs. It is also used in conjunction with the system watchdog that keeps an eye on the times the unit has started.

P931 Date

This parameter displays the **current date**, in the format as set by **P933 (Date Format)** and can be reset if required.

P932 Time

This parameter displays the **current time** and can be reset if required, in the format HH:MM (24-hour format). This is set initially at the factory for UK time.

Password

P921 Enable Code

Enables the passcode (**P922**), which means the passcode must be entered to go into program mode. If **disabled** (set to **0**), then no passcode is required, and pressing ESC and ENTER button simultaneously will allow entry into the program mode.

P922 Passcode

This is the passcode that must be used to enter program mode. The **default** is **1997**, but this can be changed to another value.

Alarm Limits

The Pulsar REFLECT intelligent transducer stores an echo trace internally when the Alarm condition is triggered. When requesting an echo trace the Alarm trace will be displayed on the graph.

The Pulsar REFLECT can be set up to capture an echo trace under certain alarm conditions; **Alarm Trace** (activates within the setpoints set in **(P951 and P952)** or **LOE Trace**.

P951 Low Limit

This parameter sets the low value (in **P104 measurement units**) for the alarm setpoint.

P952 High Limit

This parameter sets the high value (in **P104 measurement units**) for the alarm setpoint.

P953 Alarm Save Trace Mode

This parameter sets the frequency at which a trace is saved to the Pulsar REFLECTs internal memory in an alarm condition.

OPTION	DESCRIPTION
0 = Off (Default)	Trace mode is turned off.
1 = Once	When an alarm condition is activated, the REFLECT will save the first trace in its internal memory.
2 = Repeatedly	When an alarm condition is activated, the REFLECT will save the trace in its internal memory overwriting the previous trace for the new one.

LOE Save Trace

P950 Save DATEM Trace on LOE

When enabled this parameter will ensure that in the event of the unit going into a LOE situation a trace at the time of the LOE occurrence is saved for future reference.

OPTION	DESCRIPTION
0 = Off	Feature is disabled and in the event of LOE echo trace will NOT be saved.
1 = Enable (Single Trace)	In the event of a LOE situation an echo trace WILL be saved and stored for future reference. Once a LOE trace has been saved no further traces will be taken
2 = Enable Overwrite (Default)	In the event of an LOE event occurring any previous trace will be overwritten and the last LOE trace saved.

DATEM

P020 Set DATEM

This parameter allows DATEM to be reset to its default value. To reset DATEM to its default value set parameter value to 1, the trace will then be set to its default value and then update as normal. A full list of the options available in P20 are found in the table below:

OPTION	DESCRIPTION
0 = Default blank tank	Performed on an empty tank, so that all unwanted echoes from noise or obstructions are referenced out. Leaving the true echo visible once material enters the application.
1 = Default to Factory points (Default)	The DATEM is reset to its factory settings.
2 = Default to user points	The DATEM will reset to the points set by the user.
3 = Save DATEM to flash	The current DATEM will be stored to the flash memory of the connected Pulsar REFLECT when an alarm condition is activated.

P021 Set Dist.

Allows the user or service personnel to determine which echo is to be displayed. On start-up, if the unit displays an incorrect reading, then simply enter the distance from the transducer to the required level and, if an echo is present at this point, the Gate will establish itself around the chosen echo, DATEM will update in front of the Gate and reference out any other unwanted echoes.

It should be noted that DATEM will reset to default values whilst performing this function, and reform itself once it has selected an echo. Enter distance from **the face of transducer to the target** in units of measurement P104

Values: **Min. 0.000, Max. 99.00**

P905 Peak Clearance

This parameter is used to set the "**height**" above which the DATEM trace will "stand-off" from around unwanted echoes such as obstructions. Please consult Pulsar for further information and assistance on changing the value of this parameter.

P906 Side Clearance

This parameter is used to set the "**distance**" by which the DATEM trace will "stand-off" from around unwanted echoes such as obstructions. Please consult Pulsar for further information and assistance on changing the value of this parameter.

P70 DATEM Speed

This parameter is used to the speed in which the DATEM trace will react. Please consult Pulsar Measurement for further information and assistance on changing the value of this parameter.

OPTION	DESCRIPTION
0 = Slow	DATEM updates to changes on an echo at a slow rate.
1 = Medium (Default)	DATEM updates to changes on an echo at a medium rate.
2 = Fast	DATEM updates to changes on an echo at a fast rate.

Volume



Conversion

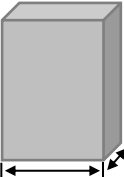
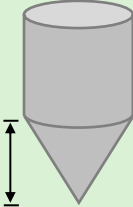

P600 Vessel Shape

This parameter determines which vessel shape is used when utilising "Volume Conversion".

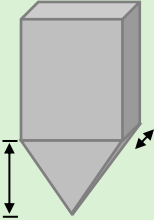
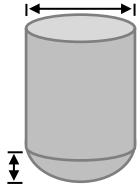
The choices are as shown in the table below, along with the **dimensions** that are required to be entered (**P601-P603**).

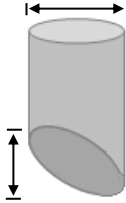
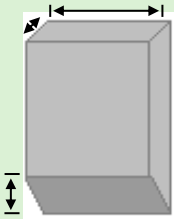
VESSEL SHAPE	P600 VALUE DESCRIPTION	DIMENSIONS
	P600 = 0 (Default) Cylindrical Flat Base	Cylinder diameter
	P600 = 1 Rectangular Flat Base	Width and Breadth
	P600 = 2 Cylindrical Cone Base	Cylinder diameter and height of bottom

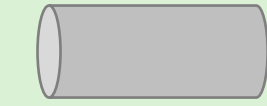
VESSEL SHAPE	P600 VALUE DESCRIPTION	DIMENSIONS
	<p>P600 = 3 Rectangular Pyramid Base</p>	<p>Height of base, Width and Breadth of Rectangle</p>
	<p>P600 = 4 Parabola Base</p>	<p>Cylinder diameter and height of bottom</p>
	<p>P600 = 5 cylindrical half sphere</p>	<p>Cylinder diameter</p>
	<p>P600 = 6 Cylindrical flat sloped base</p>	<p>Cylinder diameter and height of bottom</p>
	<p>P600 = 7 Rectangular flat sloped base</p>	<p>Width and breadth of rectangular section and height of bottom</p>

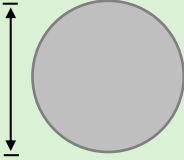
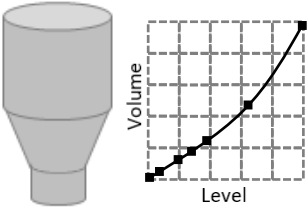
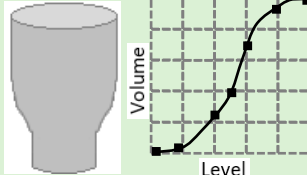
VESSEL SHAPE	P600 VALUE DESCRIPTION	DIMENSIONS
	<p>P600 = 8 Horizontal cylinder with flat ends</p>	<p>Cylinder diameter and tank length</p>
	<p>P600 = 9 Horizontal cylinder with parabolic ends</p>	<p>Cylinder diameter, length of one end and section, and tank length</p>
	<p>P600 = 10 Sphere</p>	<p>Sphere diameter</p>
	<p>P600 = 11 Universal linear</p>	<p>No dimensions required as level, and volume breakpoints are used</p>
	<p>P600 = 12 Universal curved</p>	<p>No dimensions required as level, and volume breakpoints are used</p>

P601-P603 Vessel Dimensions

These three parameters are used to enter the dimension required to calculate the volume. The dimensions required are as shown below and are entered **Measurements Units (P104)**.

VESSEL SHAPE	P601	P602	P603
P600 = 0 Cylindrical flat base	Cylinder Diameter	Not required	Not required
P600 = 1 Rectangular flat base	Not required	Width of rectangle	Breadth of rectangle
P600 = 2 Cylindrical cone base	Height of base	Width of rectangle	Not required
P600 = 3 Rectangular pyramid base	Height of base	Width of rectangle	Breadth of rectangle
P600 = 4 Cylindrical parabola base	Height of base	Cylinder diameter	Not required
P600 = 5 Cylindrical half sphere base	Cylinder diameter	Not required	Not required
P600 = 6 Cylindrical flat sloped base	Height of base	Cylinder diameter	Not required
P600 = 7 Rectangular flat sloped base	Height of base	Width of rectangle	Breadth of rectangle
P600 = 8 Horizontal cylinder flat ends	Length of cylinder	Cylinder diameter	Not required
P600 = 9 Horizontal cylinder parabolic ends	Length of cylinder	Cylinder diameter	Length of one end
P600 = 10 Sphere	Sphere diameter	Not required	Not required

P604 Calculated Volume

This parameter displays the maximum volume that has been calculated by the REFLECT and is a Read Only parameter. The volume displayed will be shown in cubic meters and is the total volume available between **empty level (P105)** and 100% of **span (P106)**.

P605 Volume Units

This parameter determines the units that you wish to display, for volume conversion. It is used in conjunction with **P607 (maximum volume)**, and the units are shown on the display. The choices are:

OPTION	DESCRIPTION
0 = No units	Volume will be totalized with no units
1 = Tons	Volume will be totalized in Tons
2 = Tonnes	Volume will be totalized in Tonnes
3 = Cubic metres (Default)	Volume will be totalized in Cubic metres
4 = Litres	Volume will be totalized in Litres
5 = UK Gallons	Volume will be totalized in UK Gallons
6 = US Gallons	Volume will be totalized in US Gallons
7 = Cubic Feet	Volume will be totalized in Cubic Feet
8 = Barrels	Volume will be totalized in Barrels

P606 Correction Factor

This parameter is used to enter a correction factor, when required, such as the specific gravity of the material so that the volume calculated is relative to the actual amount of material that can be contained between **empty level (P105)** and 100% of **span (P106)**. **Default = 1**

P607 Max Volume

This parameter displays the actual maximum volume that has been calculated by the REFLECT, i.e., **P604 Calculated Volume x P606 Correction Factor**, and is a Read Only parameter. The volume displayed will be shown in **P605 Volume Units** and is the total volume available between **empty level (P105)** and 100% of **span (P106)**.

Breakpoints

P610-P641 Level/Volume Breakpoints

These parameters are used to create a profile of the vessel when **P600=11 (universal linear)** or **P600=12 (universal curved)**. You should enter breakpoints in pairs, a reading for level and its corresponding volume. The more pairs you enter, the more accurate the profile will be. In the case of universal linear, then enter the level/volume at each of the points where the vessel changes shape. In the case of the universal curved, enter values around each arc tangent, as well as at the top and bottom.

You must enter at least two pairs, and you can enter up to 16 pairs.

Universal Linear (P600=11)

This volume calculation creates a linear approximation of the level/volume relationship and works best if the vessel has sharp angles between each section.

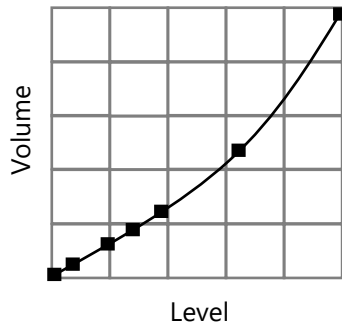

You should enter a level/volume breakpoint for each place where the vessel changes direction, and numerous where the section is slightly curved (mostly linear but has got a small arc). You can enter any number of pairs between 2 and 16.

Universal Curved (P600=12)

This volume calculation creates a curved approximation of the level/volume relationship, and works best if the vessel is non-linear, and there are no sharp angles.

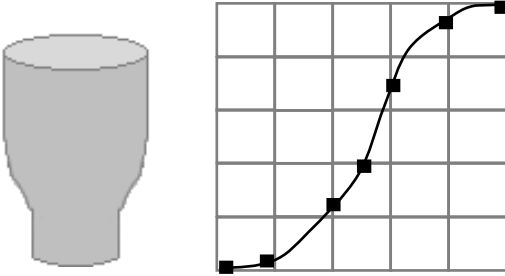

You should enter 2 level/volume breakpoints at the minimum and maximum levels, and several for each place where the vessel has got an arc. You can enter any number of pairs between 2 and 16.

Tables

P696 Reset Breakpoints

This parameter allows the resetting, to the default value, of all previously set breakpoints (P610-641), without having to access them individually. When it is necessary to reset or amend breakpoints this can be achieved by directly accessing the desired parameter (P610-641) and changing as required.

P697 Number of Breakpoints Set

This parameter allows you to review the number of breakpoints that have been set, without the need to access each individual one in turn, this is a "Read Only" parameter and no values can be entered.

CHAPTER 6 TROUBLESHOOTING

This section describes common symptoms, and suggestive solutions.

POSSIBLE CAUSES	ACTION
Transducer not firing.	Check power supply
Unit indicates a "LOE" situation.	No valid echo being received, and unit has gone into fault condition. Check material level is not out of range, sensor is perpendicular to material surface and that the correct voltage is supplying the Pulsar REFLECT.
Incorrect reading being obtained for current level.	Measure actual distance from transducer face to surface of material. Access P21 , via the Hart Communicator Software type in the measured distance , and Set Parameter . If using a front thread adaptor, the empty distance measured from the face of the adaptor to the material being measured requires an offset of 38mm (1.5"). To perform this offset, use P851 (measurement offset) and set the value of this parameter to -38mm (-1.5").
4-20ma current fixed even though level is changing.	Poll address is above 0 and is in multi drop mode. Change poll address to 0 if using a single device. Check what demo mode is set to (P239; 0=off, 1=on).
QR code doesn't work with IOS device	Scan the QR code and copy the URL, then paste into BlueFy browser.
Material level is consistently incorrect by the same amount.	Check empty level (P105) correctly entered.
LED is flashing yellow or red	Please check to see what P241 Indicator is set to. The transducer may require correct alignment, or the Pulsar REFLECT is in an alarm condition (LOE/Failed Safe) in which case please obtain an echo trace to verify all is well with the measurement. Incorrect voltage supplied to sensor, please check supply.
Unable to see REFLECT on WebApp	Make sure device is close to the Pulsar REFLECT. Is the sensor inside a metal tank? Ensure no other device is connected. Check the Bluetooth mode using REFLECT Hart Communicator. Try rebooting the Pulsar REFLECT

CHAPTER 7 DISPOSAL

Incorrect disposal can cause adverse effects to the environment.

Dispose of the device components and packaging material in accordance with regional environmental regulations including regulations for electrical \ electronic products.

Transducers

Remove power, disconnect the Transducer, cut off the electrical cable and dispose of cable and Transducer in accordance with regional environmental regulations for electrical \ electronic products.

Controllers

Remove power, disconnect the Controller, and remove battery (if fitted). Dispose of Controller in accordance with regional environmental regulations for electrical \ electronic products.

Dispose of batteries in accordance with regional environmental regulations for batteries.



 EU WEEE Directive Logo

This symbol indicates the requirements of Directive 2012/19/EU regarding the treatment and disposal of waste from electric and electronic equipment.



www.pulsarmeasurement.com

SUPPORT@PULSARMEASUREMENT.COM

Copyright © 2023 Pulsar Measurement Ltd.

Registered Address: 1 Chamberlain Square CS, Birmingham B3 3AX

Registered No.: 3345604 England & Wales

Rev 2.0