

USER'S GUIDE

Installation & Operation
Instructions

Portable Transit Time Flow Meter

Model PTFM 1.0

Manual Series A.1.4

Note: This page has been left blank intentionally.

INDEX

BATTERY 4
CONNECTIONS 4
QUICK BENCH TEST..... 5
SENSOR INSTALLATION 6
KEYPAD SYSTEM 7
CALIBRATION MENU 8
ICONS 9
MESSAGE..... 10
STATUS 10
PASSWORD..... 11
UNITS/MODE..... 12
SET UP 13
CALIBRATION 15
DATA LOGGING 16
SPECIAL FUNCTIONS..... 17
SENSOR MOUNTING 19
FIELD TROUBLESHOOTING 24
COMMON QUESTIONS AND ANSWERS..... 26
APPLICATIONS HOTLINE..... 28
PRODUCT RETURN PROCEDURE..... 29
FLOW METER DATA SHEET..... 30
APPENDIX A - CONVERSION TABLE..... 34
PIPE CHARTS 35
APPENDIX B – Liquid Speed of Sound..... 39

IMPORTANT NOTE: This instrument is manufactured and calibrated to meet product specifications. Please read this manual carefully before installation and operation. Any unauthorized repairs or modifications may result in a suspension of the warranty.

If this product is not used as specified by the manufacturer, protection may be impaired.

Available in Adobe Acrobat pdf format.

BATTERY

- A built-in rechargeable NiMH battery supplies power for 18 hours continuous operation when fully charged.
- Display brightness is adjustable to conserve power.
- State of charge is shown for normal use, sleep mode and charging.
- When switched OFF with the AC power module connected the flashing battery indicates charging, solid battery shows fully charged.
- The PTFM 1.0 will switch off automatically when the battery is fully discharged.
- Full charge requires approximately 6 hours charging.
- Sleep mode extends battery life for long term data logging. Maximum log time is 18 days at 5 minute sample rate.

CONNECTIONS

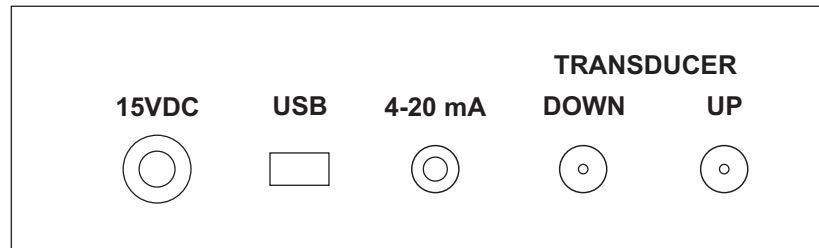

SENSORS

Use type SE16B supplied with 12 ft (4 m) coaxial cables and BNC connectors. Set of optional PTXC1 50 ft (15 m) sensor cables available.

4-20mA

Active only when powered by AC charger, maximum load 500 ohm.

USB

Cable Part #USB-PD is supplied for connecting the PTFM 1.0 to a PC or laptop.

POWER

An AC powered 15 volt DC power module is supplied for battery charging and continuous use.

QUICK BENCH TEST

In the PTFM Setup menu set parameters to perform a bench test:

- Set Fluid = Water
- Set Temperature = 20°C
- Set Pipe OD = 0.15 inch
- Set Pipe Wall = 0.06 inch
- Set Pipe material = ABS
- Set Lining = None
- Set Crossings = 4
- Press **↓** to view Signal Strength at bottom of menu.
- Press **✓** twice to exit Setup and return to main display.

From main display press **↓** to view Status menu. Apply coupling compound to the face of sensors and press together as indicated in the illustration below.

The Status menu should indicate Noise low and a high Signal Strength (75-100%).

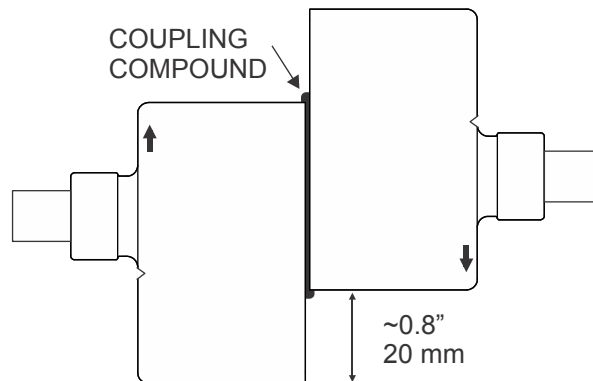

SENSOR INSTALLATION

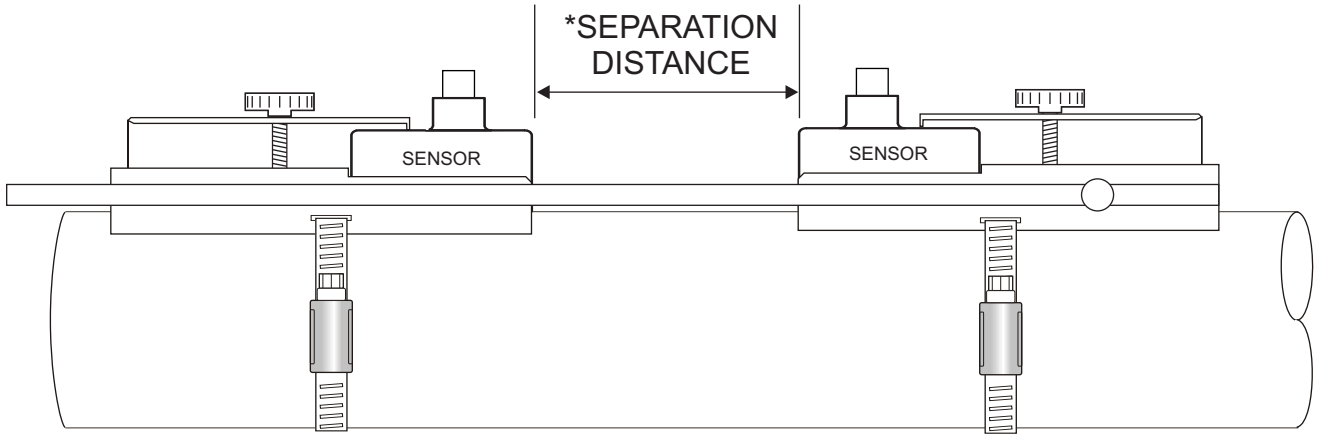

* Shown in 'Setup' display after pipe dimensions are entered.

KEYPAD SYSTEM

The following diagram shows the PTFM 1.0 menu system. Arrows show the four directions to leave a menu box. Pressing a corresponding keypad arrow will move to the next item in the direction shown. Move the cursor (highlighted) under numerals and increase or decrease numerals with the **↑** and **↓** keys.

To store calibration values permanently, press the **✓**.



CALIBRATION MENU

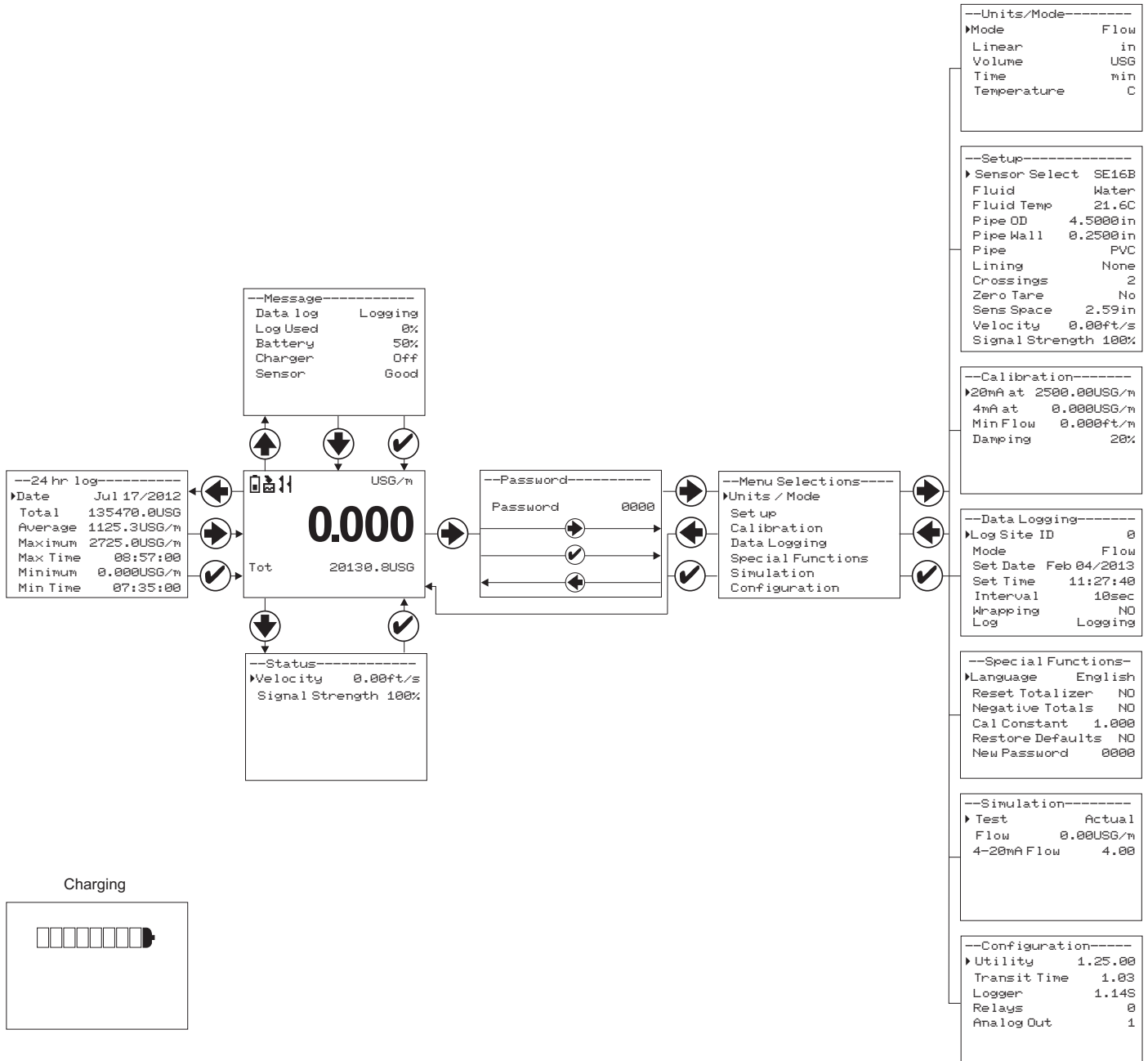

ICONS

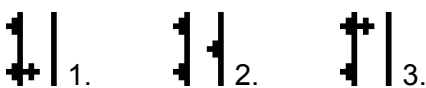
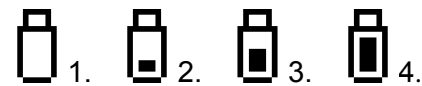
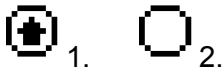

Message waiting. Press .

Battery charging.

Charger connected.

Data logging **off**.

Data logging **on**.

USB file download.

File download completed.

Download Error.

PTFM Echo OK.

PTFM – No Echo, Empty Pipe.

PTFM – No Sensors Attached / Wrong Settings.

MAIN DISPLAY

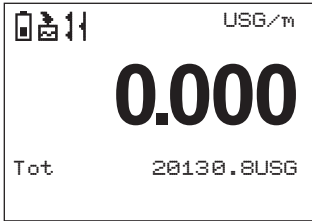

The main display shows the units selected from the Units/Mode menu, Flow or Velocity rate being measured and TOTALIZER. The PTFM 1.0 will start-up with this display.



Message is waiting.



Battery 0%



Battery 25%



Battery 50%



Battery 75%



Battery 100%



Charger connected.



Data logging off.



Data logging on.

MESSAGE

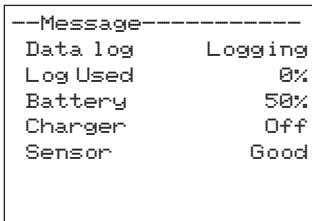

Press **↑** from the MAIN display to view error/warning messages provided by the instrument. The Message icon will appear on the MAIN display if error messages are being generated by the instrument. Press **✓** to return to the main display.

STATUS

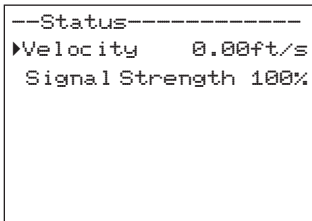

Press **↓** from the MAIN display to view instrument status.

Velocity Displayed in ft/sec or m/sec.

Signal Strength Displays percentage of signal being received by the ultrasonic sensor.

```
--24 hr log-----
▶Date      Jul 17/2012
Total     135470.0USG
Average   1125.3USG/m
Maximum   2725.0USG/m
Max Time  08:57:00
Minimum   0.000USG/m
Min Time  07:35:00
```

24 HR LOG

Press **←** from the MAIN display to view a formatted flow report from instruments with a built-in data logger. Press **↓** to scroll down one day or repeatedly to scroll to a specific date. Up to 365 days can be stored. Newest date will overwrite the oldest. Press **✓** to return to the main display.

```
--Password-----
Password      0000
  ◀────────▶
  ◀────────▶
  ◀────────▶
  ◀────────▶
```

PASSWORD

The password (a number from 0000 to 9999) prevents unauthorized access to the Calibration menu.

From the Main display press the **➡** key to get to **Password**. Factory default password is 0000 and if it has not been changed press the **✓** to proceed to the Menu Selections screen.

If a password is required, press **➡** to place the cursor under the first digit and **↓** or **↑** to set the number, then **➡** to the second digit, etc. Press **➡** or **✓** to proceed to the **Menu Selections** screen.

A new password can be stored by going to **Special Functions/New Password**.

```

--Units/Mode-----
▶Mode                Flow
Linear              in
Volume             USG
Time               min
Temperature        C
  
```

UNITS/MODE

From ▶**Mode** press the **➡** and then the **⬆** or **⬇** to select **Flow** or **Velocity**. Flow mode displays the flow rate in engineering units (e.g. gpm, litres/sec, etc.) Press the **✓** to store your selection then the **⬇** to the next menu item and **➡** to enter.

```

--Units/Mode-----
Mode                Flow
▶Linear             in
                  ft
                  m
                  mm
  
```

From ▶**Linear** press the **➡** key and then the **⬆** or **⬇** to select your units of measurement. Press the **✓** to store your selection.

Press the **⬇** key to move the ▶ symbol to each subsequent menu item and the **✓** to save your selections.

Note: the volume selection "bbl" denotes U.S. oil barrel.

```

--Units/Mode-----
Mode
Linear
▶Volume            USG
                  ft3
                  bbl
                  L
                  m3
                  IMG
                  IG
                  USMG
  
```

Press **⬅** or **✓** to return to the **Menu Selections** screen.

```

--Units/Mode-----
Mode                Flow
Linear              in
Volume             USG
▶Time              sec
                  day
                  hr
                  min
  
```

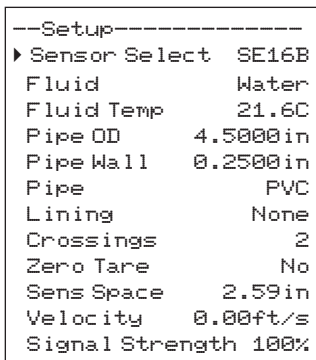

SET UP

Set Up ▶	Go directly to Set up.
Sensor Select	Choose SE16B.
Fluid Vel	When Fluid = Other – Enter the fluid velocity at 25C from table or other reference in units of m/s
ΔV/C (@25C)	When Fluid = Other – Enter fluid velocity adjustment factor over change in temperature in units of m/s per °C.
Fluid	Select fluid type. Other will require additional information:
Fluid Temp	Enter average fluid temperature.
Pipe OD	Place the cursor under the digits and then ↓ or ↑ to change the numbers and decimal point. Pipe OD should be entered as the exact outside diameter of the pipe where the sensor is mounted. Refer to the Pipe Charts Appendix in this manual for outside diameter of common pipe types and sizes.
Pipe Wall	Enter wall thickness. Refer to the Pipe Charts Appendix in this manual for thickness of common pipe materials and sizes.
Pipe Vel	When pipe = Other – Enter pipe material speed of sound (consult factory).
Pipe	Select pipe material.
Lining Thick	When Lining – Enter lining thickness
Lining Vel	When Lining = Other – Enter speed of sound of lining material.
Lining	Select Lining material. None represents no liner. Other will require additional information.

Crossings

1 = Z mounting

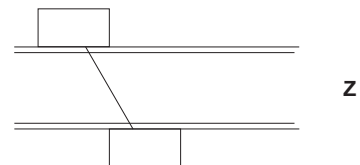

2 = V mounting

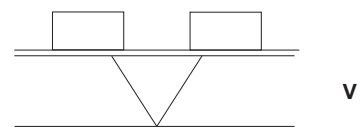

4 = W mounting

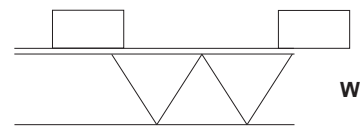

Zero Tare

To suppress readings or fluctuations at zero flow. Set Calibration/Damping to 5% and under no flow conditions and full pipe select Yes to force readings to zero.

Sens Space

Displays the calculated sensor spacing.

Velocity

Displays the measured velocity.

Signal Strength

Displays magnitude of signal being received by the ultrasonic sensor.

Press ✓ from the Units/Mode display to return to Menu Selections.

NOTE:

Sensor separation distance is automatically calculated by the instrument and will be displayed in the Setup menu.

```
--Calibration-----  
▶ 20mA at 2500.0 USG/m  
4mA at 0.000 USG/m  
Min Flow 2.262 USG/m  
Damping 5%
```

CALIBRATION

Press the **↓** to **▶Calibration** and **▶** to enter. Use **↓** or **↑** to position **▶** before each menu item and **▶** to enter. When settings are completed press **✓** to store and return to the **Calibration** menu.

- *20mA at** Press **▶** then **↓** or **↑** to change the numbers and decimal point. Use this menu to set the corresponding flow rate that will be represented by 20mA analog output. If maximum flow is unknown, enter an estimated flow rate and observe actual flow to determine the correct maximum value. Any velocity or flow rate up to +40 ft/sec (12.2 m/sec) may be selected.

- *4mA at** Press **↓** or **↑** to set the flow rate corresponding to 4mA analog output. This setting may be left at zero flow (or velocity or can be raised to any value less than the 20mA setting, or lowered to any velocity or corresponding flow rate down to -40 ft/sec (-12.2 m/sec).

- Min Flow** Flow rates below this setting will be displayed as zero flow.

- Damping** Increase damping to stabilize readings under turbulent flow conditions. Decrease for fast response to small changes in flow. Damping is shown in percentage (maximum is 99%). Factory default is 20%.

Press **✓** from the **Units/Mode** display to return to **Menu Selections**.

***Note** 4-20mA circuitry is only powered by the AC power module. To conserve power this output is not active in battery power mode.

```
--Data Logging-----
Log Site ID      0
Mode             Flow
Set Date        Jul 17/2012
Set Time        11:27:40
Interval        10sec
Log             Logging
```

DATA LOGGING Setup

Select **Data Logging** from Menu Selections.

- Log Site ID** Enter a number from 00 to 99. The site ID will become part of the downloaded file name to help distinguish downloads from different instruments. Press ✓ to store the setting.
- Mode** Select Velocity (e.g. ft/sec or m/sec). **Flow** (e.g. USGPM or l/sec). Press ✓ to store the setting.
- Set Date** Press ↑ or ↓ to scroll and select Month, Day and Year. Press ✓ to store the setting.
- Set Time** Press ↑ or ↓ to select the current time in Hours, Minutes and Seconds. Press ✓ to store the setting.
- Interval** Press ↑ or ↓ to select the logging interval. Press ✓ to store the setting.
- Log** Select **Start** then ✓ to start logger. Select **Stop** then ✓ to stop logger. Select **Delete** then ✓ to clear all previous logging sessions.

RETRIEVE LOG FILE

Install Greyline Logger on your PC or laptop. Refer to the Help menu in the program for detailed instructions.

- Connect the PTFM 1.0 to the PC using the supplied USB cable.
- Install the USB driver program from the install CD.
- Start the Greyline Logger Software.
- Select "xxxx scan for USB instruments xxxx" in the drop down window at the top of the main window. PTFM 1.0 will be indicated.
- Click the download icon to start transferring data.
- Downloaded data appears in a pop-up window.

```
--Special Functions--
▶Language      English
Reset Totalizer  NO
Negative Totals  NO
Cal Constant    1.000
Restore Defaults NO
New Password    0000
```

SPECIAL FUNCTIONS

- Language** Select English, French or Spanish
- Reset Totalizer** Press **➡** and select **Yes** to erase and restart the totalizer at zero.
- Negative Totals** Select **Yes** to have reverse flow readings deducted from the totalizer. Select **NO** to totalize forward flow only and ignore reverse flow.
- Cal Constant** Factory set during calibration. (Refer to the calibration certificate supplied with your instrument.)
- Restore Defaults** Select **Yes** and press **✓** to erase all user settings and return the instrument to factory default settings.
- New Password** Select any number from 0000 to 9999 and press **✓**. Default setting of 0000 will allow direct access to the calibration menus. Setting of any password greater than 0000 will require the password to be entered to access the calibration menus.

Press **✓** to return to **Menu Selections**.

--Simulation-----	
▶ Test	Actual
Flow	0.00USG/m
4-20mA Flow	4.00

SIMULATION

Exercises the 4-20mA.

Test Select **Maximum** and press ✓ to simulate maximum Flow or Velocity and to output 20mA to the analog channel.

Select **Minimum** and press ✓ to simulate minimum Flow or Velocity and to output 4mA to the analog channel.

To simulate measurements between minimum and maximum set **Test** to **Actual** and then enter for the flow measurement. The analog output will respond to the simulated value.

SLEEP MODE

Logging in sleep mode requires a minimum sample time of 30 seconds. Selecting sleep mode for 10 second sampling rate results in instrument always being 'awake'.

BACKLIGHT

Three levels of backlight are selectable to conserve power.

CHARGING

A flashing battery indicates charging.
A solid battery indicates fully charged.

SENSOR MOUNTING LOCATION

The position of the sensor is one of the most important considerations for accurate Transit Time flow measurement. The same location guidelines apply to Transit Time as most other types of flow meters.

Before permanently mounting a Transit Time sensor onsite testing is recommended to determine optimum mounting position. Use the sensor coupling compound (supplied with each Greyline flow meter, or petroleum gel, acoustic compound or electrocardiograph gel). Take several readings around the axis of the pipe and then at several points upstream and downstream from the selected position, checking for consistent readings. Avoid high or low reading areas. Mount the sensors where consistent (average) readings were obtained or continue testing on another pipe section.

VERTICAL OR HORIZONTAL PIPE - Vertical pipe runs generally provide evenly distributed flow. On Horizontal pipes and liquids with high concentrations of gas or solids, the sensors should be mounted on the side (1 to 5 o'clock positions) to avoid concentrations of gas at the top of the pipe, or solids at the bottom.

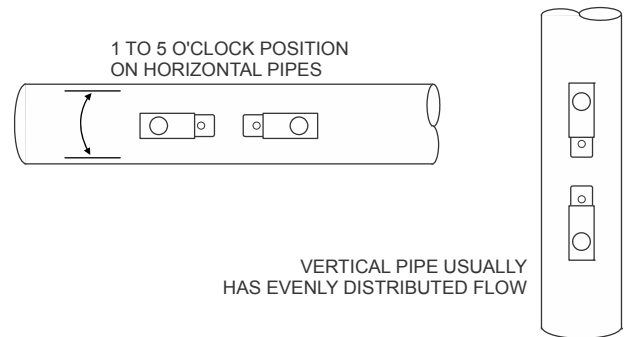

VELOCITY INCREASING DEVICES: Generally the sensors must be mounted away from flow disturbances such as valves, pumps, orifice plates, venturis or pipe inlets and discharges which tend to increase flow velocity. Velocity increasing devices often cause cavitation, or rapid release of gas bubbles, and readings both up and downstream may be intermittent or inaccurate. As a guideline, mount the sensor at least 20 diameters upstream or 30 diameters downstream from velocity increasing devices.

Required distance from a velocity increasing device will vary in applications depending on the flow velocity and the characteristics of the liquid itself.

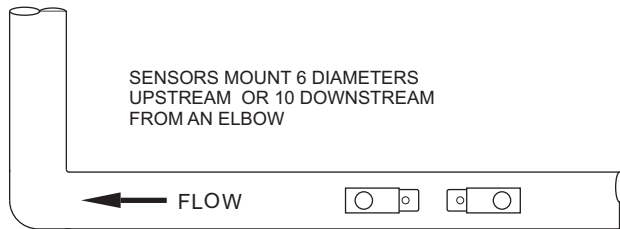

TURBULENCE INCREASING DEVICES: Elbows, flanged connections and tees tend to introduce desirable conditions of an evenly distributed flow profile. Sensor mounting 6 pipe diameters upstream and 10 diameters downstream from these disturbances is generally optimum.

The sensors are designed to mount longitudinally on a straight section of pipe. Do not attempt to mount it on bends, elbows or fittings.

SENSOR MOUNTING

Prepare an area 2" wide by 4" long (50mm x 100mm) for sensor bonding by removing loose paint, scale and rust. The objective of site preparation is to eliminate any discontinuity between the sensor and the pipe wall, which would prevent acoustical coupling.

A TMK1 Sensor Mounting Kit is supplied with each Greyline flow meter. It includes recommended coupling compound in a plastic applicator and a stainless steel mounting bracket with adjustable pipe straps. Use the Alignment Bar (included) to align sensor brackets for V and W mode mounting.

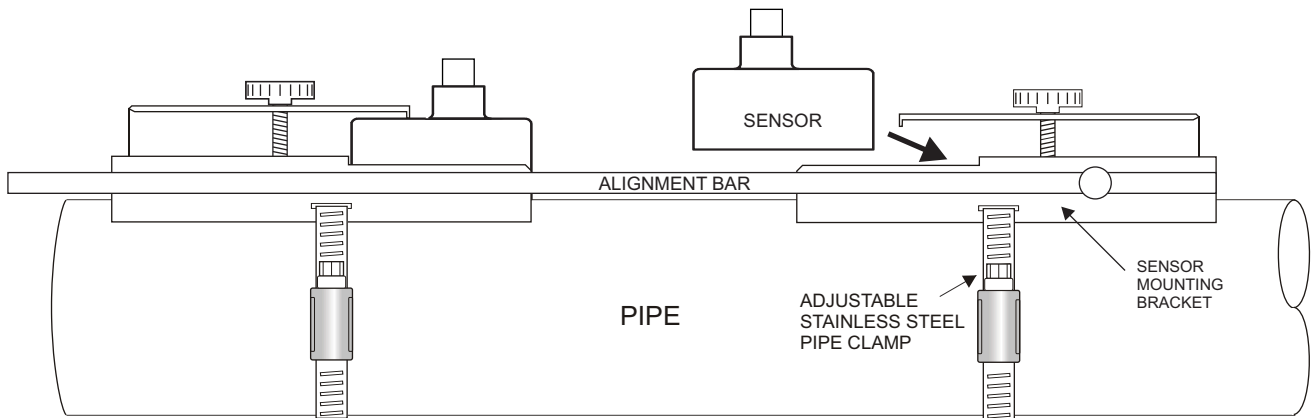

Mount the PC16 Mounting Bracket as illustrated on pipes 0.6" / 15 mm OD or larger. Stainless steel bands are included for mounting on pipes up to 30" / 750 mm OD.

Additional stainless steel bands (by customer) may be combined to mount on larger pipes.

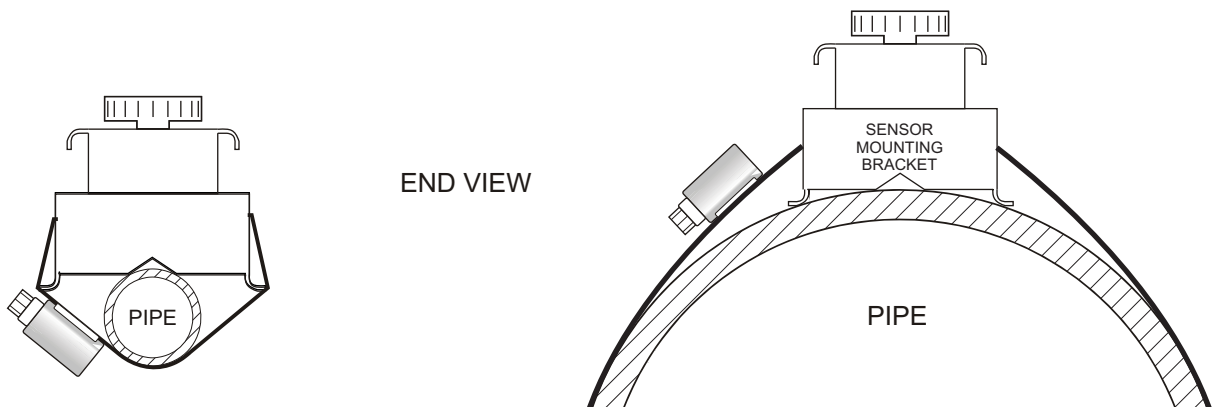

SEPARATION DISTANCE

Measure separation distance with a ruler or tape measure. Separation distance is automatically calculated by the PTFM 1.0 based on parameters entered in the **Set-up** menu. **Sens Space** is displayed on the **Setup** menu.

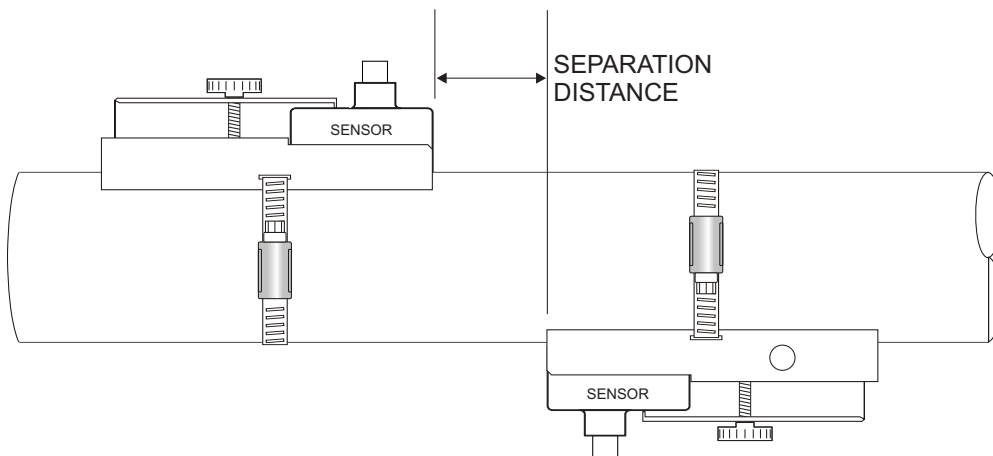
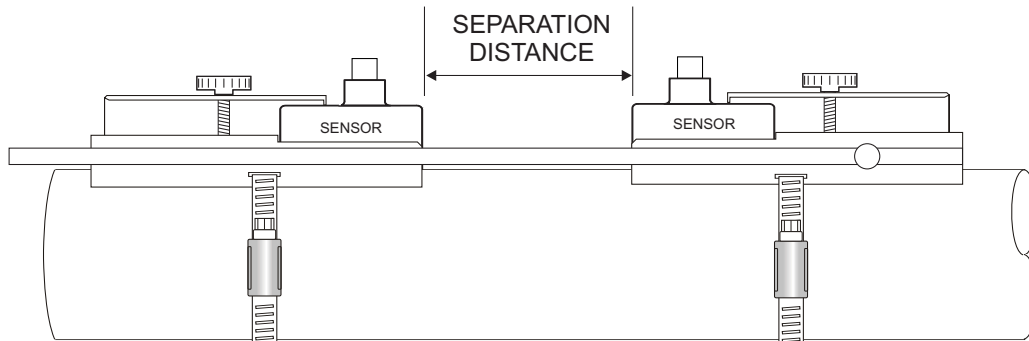

SENSOR COUPLING

For permanent or temporary bonding, the following are recommended:

- a) Dow Corning silicon compound #4 (supplied)
Additional supply: order Greyline Option CC
- b) Water-based sonic compound: Order Greyline Option CC30
- c) Electrocardiograph gel
- d) Petroleum gel (Vaseline)

The above are arranged in their order of preferred application.
d & e are only good for temporary bonding at room temperature.
DO NOT USE: Silicon RTV caulking compound (silicon rubber).

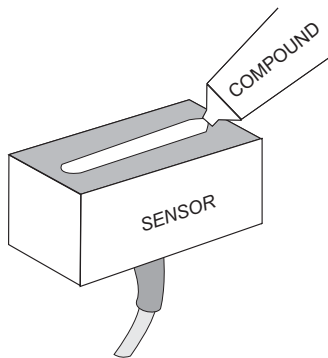

Use the pipe clamp and rail (supplied) as illustrated on previous page or use a loop of electrical tape for temporary mounting. Apply silicon coupling compound #4 to the colored face of the sensor. A bead, similar to toothpaste on a toothbrush, is ideal. Do not overtighten (crush the sensor).

The sensor must be fixed securely to the pipe with coupling material between the sensor face and the pipe. Sensor installation with excessive coupling compound can result in gaps or voids in the coupling and cause errors or loss of signal. Insufficient coupling compound will create similar conditions.

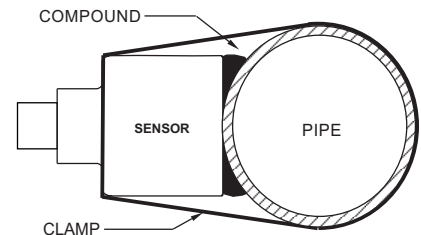

Over time temporary coupling compounds (e.g. Petroleum Gel) may gradually sag away from the sensor resulting in reduced signal strength and finally complete loss of signal. Warm temperatures, moisture and vibration will accelerate this process. Dow Corning Silicone Compound #4 as supplied with the PTFM 1.0 (and available from Greyline Instruments) is recommended for semi-permanent installations.

SENSOR MOUNTING/COUPLING RECOMMENDATIONS

BAD

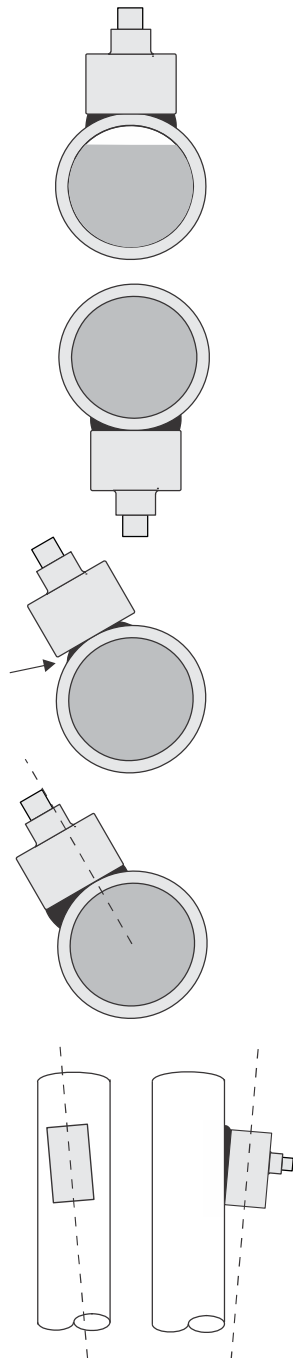

GOOD

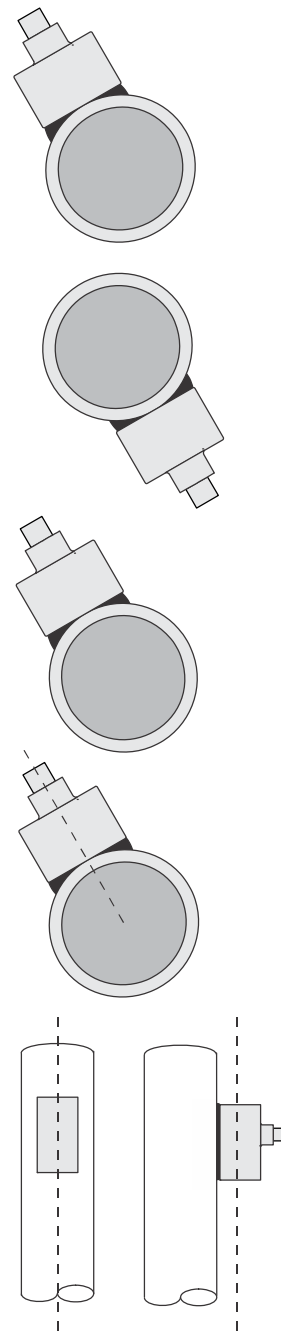

FIELD TROUBLESHOOTING

<i>Possible Causes:</i>	<i>Corrective Action:</i>
METER READING WHEN THERE IS NO FLOW?	
Erratic measurement (set damping to 0% to check) due to electrical noise or poor signal quality.	<ul style="list-style-type: none"> • Set Calibration / Damping to 5% with zero flow use Setup / Tare function. • Try adjusting sensor spacing (+/- 10%) and contact Greyline for further assistance. • Adjust Calibration / Min Flow setting.
Variable Speed Drive interference	<ul style="list-style-type: none"> • Follow Drive manufacturers wiring and Grounding instructions • Relocate Flowmeter, Sensors and wiring away from VSD
Sensor cable connections incorrect or loose	<ul style="list-style-type: none"> • Disconnect and reconnect sensor cables ensuring that cable plugs are properly inserted into terminals and tightened.
METER READING LOWER THAN EXPECTED?	
Calibration Error	<ul style="list-style-type: none"> • Review calibration menu. Pipe dimensions and fluid selection/fluid velocity.
Lower flow rate than expected	<ul style="list-style-type: none"> • Investigate pump/valves. Compare velocity with alternate instrument.
Erratic measurement (set damping to 0% to check) due to electrical noise or poor signal quality.	<ul style="list-style-type: none"> • Try adjusting sensor spacing (+/- 10%) and contact Greyline for further assistance.
NO ECHO INDICATION (Icon: No Echo)?	
Sensor Connections	<ul style="list-style-type: none"> • Check sensor connections at PTFM
Sensors not mounted to Pipe or mounted improperly	<ul style="list-style-type: none"> • Apply coupling compound and mount sensors to pipe with proper sensor spacing.
Empty pipe or partially filled	<ul style="list-style-type: none"> • Pipe must be fluid filled and acoustically transparent in order to obtain echoes.

<i>Possible Causes:</i>	<i>Corrective Action:</i>
Coupling compound washed out, or sensor loose on pipe.	<ul style="list-style-type: none"> • Remount sensor • Use Dow Corning Silicone #4
<i>METER READING HIGHER THAN EXPECTED?</i>	
Calibration Error	<ul style="list-style-type: none"> • Review calibration menu. Pipe dimensions and fluid selection/fluid velocity.
Higher flow rate than expected	<ul style="list-style-type: none"> • Investigate pump/valves. Compare velocity with alternate instrument.
Erratic measurement (set damping to 0% to check) due to electrical noise or poor signal quality.	<ul style="list-style-type: none"> • Try adjusting sensor spacing (+/- 10%) and contact Greyline for further assistance.
Pipe not Full	<ul style="list-style-type: none"> • Verify pipe is full by mounting sensors at top of pipe and check echo icon. No echo if pipe is not full.
High viscosity fluid	<ul style="list-style-type: none"> • Laminar flow profile due to high viscosity fluid requires an adjustment to Cal Const.

COMMON QUESTIONS AND ANSWERS

The pipe vibrates. Will it affect the flow meter?

Common vibration frequencies are far lower than the sonic frequencies used by the Greyline flow meter, and will not normally affect accuracy or performance. However, applications where very weak Transit Time signal is present (when sensitivity is adjusted to maximum and signal strength is low), accuracy may be affected by pipe vibration, or the flow meter may show readings under no-flow conditions. Attempt to relocate the sensor on a pipe section where vibration is reduced, or arrange pipe mounting brackets to reduce vibration at the sensor mounting location.

The flow meter must be installed in a high noise environment. Will this affect operation?

Greyline flow meters are designed to discriminate between environmental noise and the Transit Time signal. High noise environments may affect the flow meter's performance where low signal strength and/or low flow velocities are being measured. Relocate the sensor in a quieter environment if possible.

Will pipe corrosion affect accuracy of the flow meter?

Yes. Rust, loose paint etc. must be removed from the outside of the pipe to provide a clean mounting position when installing a Transit Time sensor. Severe corrosion/oxidation on the inside of the pipe may prevent the Transit Time signal from penetrating into the flow. If the pipe cannot be cleaned, a spool piece (PVC recommended) should be installed for sensor mounting.

What effect do pipe liners have on the flow meter?

The air gap between loose insertion liners and the pipe wall prevent the Transit Time signal from entering the flow. Better results can be expected with bonded liners such as cement, epoxy or tar, however an on site test is recommended to determine if the application is suitable for a Transit Time flow meter.

Why is Transit Time recommended for clean liquids?

The Transit Time sensor transmits sound across the flow stream in order to measure sound velocity and therefore requires a fluid medium that is relatively transparent to the acoustic signal. The Transit Time system will not function when there is high volume of solids or aeration. As a guideline, Greyline Transit Time flow meters are recommended for clean liquids with solids or bubbles content less than 2%. Most applications such as water, chemicals and oils will meet this minimum requirement.

Can the sensor be submerged in water?

Yes, for short periods of time or by accident, but it is not recommended for continuous operation. The sensor is constructed to withstand submersion to 10 psi (0.7 Bar) without damage. Plastic seal jackets on the sensor cables can be filled with coupling compound to provide additional moisture protection for the BNC connectors.

What is the purpose of the Signal Strength Display?

The primary function of the signal strength display is to assist as a feedback when mounting sensors. Signal Strength can also be a useful diagnostics tool when troubleshooting problems with an installation. A low signal strength (< 10%) will cause the PTFM to be more susceptible to environmental noise and may indicate a problem with the installation or other qualitative issues.

Does the PTFM 1.0 require periodic recalibration?

PTFM 1.0 calibration does not normally drift over time. Greyline offers a calibration service to verify instrument accuracy.

Can the internal batteries be replaced?

The built-in rechargeable NiMH battery pack is not user-serviceable. The meter should be returned to Greyline for battery service.



PTFM 1.0 Portable Transit Time Flow Meter

APPLICATIONS HOTLINE

For applications assistance, advice or information on any Greyline Instrument contact your Sales Representative, write to Greyline or phone the Applications Hotline below:

United States:	Tel: 315-788-9500	Fax: 315-764-0419
Canada:	Tel: 613-938-8956	Fax: 613-938-4857
Toll Free:	888-473-9546	
Email:	info@greyline.com	
Web Site:	www.greyline.com	

Greyline Instruments Inc.

Canada
16456 Sixsmith Drive
Long Sault, Ont. K0C 1P0

USA:
105 Water Street
Massena, NY 13662

PRODUCT RETURN PROCEDURE

Instruments may be returned to Greyline for service or warranty repair.

1 Obtain an RMA Number from Greyline -

Before shipping a product to the factory please contact Greyline by telephone, fax or email to obtain an RMA number (Returned Merchandise Authorization). This ensures fast service and correct billing or credit.

When you contact Greyline please have the following information available:

1. Model number / Software Version
2. Serial number
3. Date of Purchase
4. Reason for return (description of fault or modification required)
5. Your name, company name, address and phone number

2 Clean the Sensor/Product -

Important: unclean products will not be serviced and will be returned to the sender at their expense.

1. Rinse sensor and cable to remove debris.
2. If the sensor has been exposed to sewage, immerse both sensor and cable in a solution of 1 part household bleach (Javex, Clorox etc.) to 20 parts water for 5 minutes. Important: do not immerse plug end of sensor cable.
3. Dry with paper towels and pack sensor and cable in a sealed plastic bag.
4. Wipe the outside of the enclosure to remove dirt or deposits.
5. Return to Greyline for service.

3 Ship to Greyline -

After obtaining an RMA number please ship the product to the appropriate address below:

Canadian and International
Customers:

Greyline Instruments Inc.
16456 Sixsmith Drive
Long Sault, Ont. K0C 1P0

RMA#

USA
Customers:

Greyline Instruments Inc.
204 150th Avenue
Madeira Beach, FL 33708

RMA#



FLOW METER DATA SHEET

<input type="checkbox"/> 16456 Sixsmith Drive, Long Sault, ON K0C 1P0 Tel: 613-938-8956 / Fax: 613-938-4857 <input type="checkbox"/> 105 Water Street, Massena, NY 13662 Tel: 315-788-9500 / Fax: 315-764-0419		Please complete and return this form to Greyline. It is important. We use this information to check our database for performance of Greyline flow meters in similar applications, and to provide advice and recommendations to you. Thank you for your cooperation.	
Contact Information	Contact		
	Title/Dept		
	Company		
	Address		
	Address		
	Tel		
	Fax		
	Email		
Mobile			
Service Conditions	Pipe Run	<input type="checkbox"/> Vertical	<input type="checkbox"/> Horizontal
	Pipe Full	<input type="checkbox"/> Yes	<input type="checkbox"/> No
	Fluid Type		
	% of Solids		
	Nominal Pipe Size and Schedule		
	Pipe Outside Diameter		
	Wall Thickness		
	Pipe Material		
	Liner Material		
	Liner Thickness		
	Normal Flow		
	Maximum Flow		
	Minimum Flow		
	Maximum Temperature		
	Maximum Pressure		
Vibration	<input type="checkbox"/> Yes	<input type="checkbox"/> No	
Hazardous Rating			
Notes / Additional Comments / Pipe Run Diagram:			

LIMITED WARRANTY

Greyline Instruments warrants, to the original purchaser, its products to be free from defects in material and workmanship for a period of one year from date of invoice. Greyline will replace or repair, free of charge, any Greyline product if it has been proven to be defective within the warranty period. This warranty does not cover any expenses incurred in the removal and re-installation of the product.

If a product manufactured by Greyline should prove defective within the first year, return it freight prepaid to Greyline Instruments along with a copy of your invoice.

This warranty does not cover damages due to improper installation or handling, acts of nature, or unauthorized service. Modifications to or tampering with any part shall void this warranty. This warranty does not cover any equipment used in connection with the product or consequential damages due to a defect in the product.

All implied warranties are limited to the duration of this warranty. This is the complete warranty by Greyline and no other warranty is valid against Greyline. Some states do not allow limitations on how long an implied warranty lasts or limitation of incidental or consequential damages, so the above limitations or exclusions may not apply to you.

This warranty gives you specific legal rights, and you may also have other rights which vary from state to state.

Greyline Instruments Inc.

SPECIFICATIONS

Flow Rate Range:	± 0.07 to 39 ft/sec (± 0.02 to 12 m/sec) in most applications	
Pipe Size:	Ultrasonic Sensor mounts on any pipe from 1/2" to 48" ID (12 mm to 1200 mm)	
Display:	White, backlit matrix - displays flow rate, totalizer, operating mode and calibration menu	
Power Input:	Built-in NiMH battery for up to 18 hours continuous operation External charger with 100-240VAC 50/60Hz input	
Outputs:	4-20mA (500 ohm) when AC powered USB for Data Log transfer by direct PC connection	
Data Logger:	Programmable 300,000 data point capacity, time and date stamped or formatted flow reports including total, average, minimum, maximum and times of occurrence	
PC Software:	'Greyline Logger' for Windows 98 or higher. Retrieves, displays and saves data log files	
Electronics Operating Temperature:	-5° to 140°F (-20° to 60°C)	
Electronics Enclosure:	Portable, ABS enclosure	
Carry Case:	Rated IP67 with protective molded foam insert	
Accuracy:	$\pm 1\%$ of reading or 0.1 ft/sec (0.03 m/sec), whichever is greater. Repeatability: $\pm 0.25\%$, Linearity: $\pm 0.5\%$	
Calibration:	Built-in 5-key programming with user-friendly calibration menu. Password protected.	
Language Selection:	English, French, Spanish	
Sensitivity:	Adjustable signal cut-off, signal strength and damping	
Approvals:	Charger is CE and UL approved. The PTFM 1.0 is not certified for use in hazardous rated locations.	

ENCLOSURE

SE16B Transit Time Sensor

- Pipe Diameter:** ½" to 48" (12 mm to 1200 mm)
- Operating Temperature:** -40° to 300°F (-40° to 150°C)
- Operating Frequency:** 1.28 MHz
- Sensor Cable:** PTC12 12 ft (4 m) with BNC connectors and seal jackets
Optional PTC50 50 ft (15 m) with BNC connectors and seal jackets
- Submersion Rating:** Withstands accidental submersion pressure up to 10 psi (0.7 Bar)

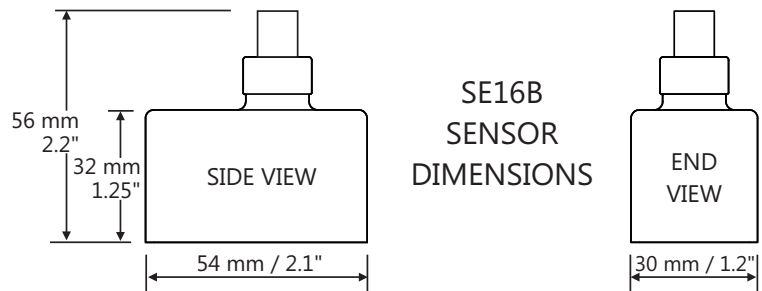

APPENDIX A - CONVERSION TABLE

CONVERSION GUIDE		
FROM	TO	MULTIPLY BY
US GALLONS	CUBIC FEET	0.1337
US GALLONS	IMPERIAL GALS	0.8327
US GALLONS	LITRES	3.785
US GALLONS	CUBIC METERS	0.003785
LITRES/SEC	GPM	15.85
LITRES	CUBIC METERS	0.001
BARRELS	US GALLONS	42
BARRELS	IMPERIAL GALS	34.9726
BARRELS	LITRES	158.9886
INCHES	MM	25.4
DEGREES F	DEGREES C	$(^{\circ}\text{F}-32) \times 0.556$
POUNDS	KILOGRAMS	0.453
PSI	BAR	0.0676
FOOT ²	METER ²	0.0929

Note: BARRELS are U.S. oil barrels.

PIPE CHARTS

Carbon Steel & PVC Pipe

Pipe Size	Pipe O.D.	Standard		Extra Heavy		DbL. Extra Heavy		Schedule 10		Schedule 20		Schedule 30		Schedule 40	
		I.D.	WALL	I.D.	WALL	I.D.	WALL	I.D.	WALL	I.D.	WALL	I.D.	WALL	I.D.	WALL
½	.840	.622	.109	.546	.147	.252	.294							.622	.109
¾	1.050	.824	.113	.742	.154	.434	.308							.824	.113
1	1.315	1.049	.133	.957	.179	.599	.358							1.049	.133
1¼	1.660	1.380	.140	1.278	.191	.896	.382							1.380	.140
1½	1.900	1.610	.145	1.500	.200	1.100	.400							1.610	.145
2	2.375	2.067	.154	1.939	.218	1.503	.436							2.067	.154
2½	2.875	2.469	.203	2.323	.276	1.771	.552							2.469	.203
3	3.500	3.068	.216	2.900	.300	2.300	.600							3.068	.216
3½	4.000	3.548	.226	3.364	.318	2.728	.636							3.548	.226
4	4.500	4.026	.237	3.826	.337	3.152	.674							4.026	.237
5	5.563	5.047	.258	4.813	.375	4.063	.750							5.047	.258
6	6.625	6.065	.280	5.761	.432	4.897	.864							6.065	.280
8	8.625	7.981	.322	7.625	.500	6.875	.875			8.125	.250	8.071	.277	7.981	.322
10	10.750	10.020	.365	9.750	.500	8.750	1.000			10.250	.250	10.136	.307	10.020	.365
12	12.750	12.000	.375	11.750	.500	10.750	1.000			12.250	.250	12.090	.330	11.938	.406
14	14.000	13.250	.375	13.000	.500			13.500	.250	13.376	.312	13.250	.375	13.124	.438
16	16.000	15.250	.375	15.000	.500			15.500	.250	15.376	.312	15.250	.375	15.000	.500
18	18.000	17.250	.375	17.000	.500			17.500	.250	17.376	.312	17.124	.438	16.876	.562
20	20.000	19.250	.375	19.000	.500			19.500	.250	19.250	.375	19.000	.500	18.814	.593
22	22.000	21.250	.375	21.000	.500			21.500	.250	21.250	.375	21.000	.500		
24	24.000	23.250	.375	23.000	.500			23.500	.250	23.250	.375	22.876	.562	22.626	.687
26	26.000	25.250	.375	25.000	.500			25.376	.312	25.000	.500				
28	28.000	27.250	.375	27.000	.500			27.376	.312	27.000	.500	26.750	.625		
30	30.000	29.250	.375	29.000	.500			29.376	.312	29.000	.500	28.750	.625		
32	32.000	31.250	.375	31.000	.500			31.376	.312	31.000	.500	30.750	.625		
34	34.000	33.250	.375	33.000	.500			33.376	.312	33.000	.500	32.750	.625		
36	36.000	35.250	.375	35.000	.500			35.376	.312	35.000	.500	34.750	.625		
42	42.000	41.250	.375	41.000	.500					41.000	.500	40.750	.625		

Ductile Iron Pipe - Standard Classes

Size INCH	OUTSIDE DIA. INCH	Class 50		Class 51		Class 52		Class 53		Class 54		Class 55		Class 56		CEMENT LINING	
		WALL	I.D.	WALL	I.D.	WALL	I.D.	WALL	I.D.	WALL	I.D.	WALL	I.D.	WALL	I.D.	**STD	**DOUBLE
																THICKNESS	THICKNESS
3	3.96			0.25	3.46	0.28	3.40	0.31	3.34	0.34	3.28	0.37	3.22	0.41	3.14		
4	4.80			0.26	4.28	0.29	4.22	0.32	4.16	0.35	4.10	0.38	4.04	0.44	3.93		
6	6.90	0.25	6.40	0.28	6.34	0.31	6.28	0.34	6.22	0.37	6.16	0.40	6.10	0.43	6.04	.125	.250
8	9.05	0.27	8.51	0.30	8.45	0.33	8.39	0.36	8.33	0.39	8.27	0.42	8.21	0.45	8.15		
10	11.10	0.39	10.32	0.32	10.46	0.35	10.40	0.38	10.34	0.41	10.28	0.44	10.22	0.47	10.16		
12	13.20	0.31	12.58	0.34	12.52	0.37	12.46	0.40	12.40	0.43	12.34	0.46	12.28	0.49	12.22		
14	15.30	0.33	14.64	0.36	14.58	0.39	14.52	0.42	14.46	0.45	14.40	0.48	14.34	0.51	14.28		
16	17.40	0.34	16.72	0.37	16.66	0.40	16.60	0.43	16.54	0.46	16.48	0.49	16.42	0.52	16.36		
18	19.50	0.35	18.80	0.38	18.74	0.41	18.68	0.44	18.62	0.47	18.56	0.50	18.50	0.53	18.44	.1875	.375
20	21.60	0.36	20.88	0.39	20.82	0.42	20.76	0.45	20.70	0.48	20.64	0.51	20.58	0.54	20.52		
24	25.80	0.38	25.04	0.41	24.98	0.44	24.92	0.47	24.86	0.50	24.80	0.53	24.74	0.56	24.68		
30	32.00	0.39	31.22	0.43	31.14	0.47	31.06	0.51	30.98	0.55	30.90	0.59	30.82	0.63	30.74		
36	38.30	0.43	37.44	0.48	37.34	0.62	37.06	0.58	37.14	0.63	37.04	0.68	36.94	0.73	36.84		
42	44.50	0.47	43.56	0.53	43.44	0.59	43.32	0.65	43.20	0.71	43.08	0.77	42.96	0.83	42.84	.250	.500
48	50.80	0.51	49.78	0.58	49.64	0.65	49.50	0.72	49.36	0.79	49.22	0.86	49.08	0.93	48.94		
54	57.10	0.57	55.96	0.65	55.80	0.73	55.64	0.81	55.48	0.89	55.32	0.97	55.16	1.05	55.00		

**REDUCE I.D. BY DIMENSION SHOWN

Stainless Steel, Hastelloy "C" & Titanium Pipe

Pipe Size	Pipe O.D.	Schedule 5 S (a)		Schedule 10 S (a)		Schedule 40 S		Schedule 80 S	
		I.D.	WALL	I.D.	WALL	I.D.	WALL	I.D.	WALL
½	.840	.710	.065	.674	.083	.622	.109	.546	.147
¾	1.050	.920	.065	.884	.083	.824	.113	.742	.154
1	1.315	1.185	.065	1.097	.109	1.049	.133	.957	.179
1¼	1.660	1.530	.065	1.442	.109	1.380	.140	1.278	.191
1½	1.900	1.770	.065	1.682	.109	1.610	.145	1.500	.200
2	2.375	2.245	.065	2.157	.109	2.067	.154	1.939	.218
2½	2.875	2.709	.083	2.635	.120	2.469	.203	2.323	.276
3	3.500	3.334	.083	3.260	.120	3.068	.216	2.900	.300
3½	4.000	3.834	.083	3.760	.120	3.548	.226	3.364	.318
4	4.500	4.334	.083	4.260	.120	4.026	.237	3.826	.337
5	5.563	5.345	.109	5.295	.134	5.047	.258	4.813	.375
6	6.625	6.407	.109	6.357	.134	6.065	.280	5.761	.432
8	8.625	8.407	.109	8.329	.148	7.981	.322	7.625	.500
10	10.750	10.482	.134	10.420	.165	10.020	.365	9.750	.500
12	12.750	12.438	.156	12.390	.180	12.000	.375	11.750	.500
14	14.000	13.688	.156	13.624	.188				
16	16.000	15.670	.165	15.624	.188				
18	18.000	17.670	.165	17.624	.188				
20	20.000	19.634	.188	19.564	.218				
22	22.000	21.624	.188	21.564	.218				
24	24.000	23.563	.218	23.500	.250				

Pipe Size	Pipe O.D.	Schedule 60		Schedule 80		Schedule 100		Schedule 120		Schedule 140		Schedule 160	
		I.D.	WALL	I.D.	WALL	I.D.	WALL	I.D.	WALL	I.D.	WALL	I.D.	WALL
½	.840			.546	.147							.466	.187
¾	1.050			.742	.154							.614	.218
1	1.315			.957	.179							.815	.250
1¼	1.660			1.278	.191							1.160	.250
1½	1.900			1.500	.200							1.338	.281
2	2.375			1.939	.218							1.689	.343
2½	2.875			2.323	.276							2.125	.375
3	3.500			2.900	.300							2.624	.438
3½	4.000			3.364	.318								
4	4.500			3.826	.337			3.624	.438			3.438	.531
5	5.563			4.813	.375			4.563	.500			4.313	.625
6	6.625			5.761	.432			5.501	.562			5.189	.718
8	8.625	7.813	.406	7.625	.500	7.439	.593	7.189	.718	7.001	.812	6.813	.906
10	10.750	9.750	.500	9.564	.593	9.314	.718	9.064	.843	8.750	1.000	8.500	1.125
12	12.750	11.626	.562	11.376	.687	11.064	.843	10.750	1.000	10.500	1.125	10.126	1.312
14	14.000	12.814	.593	12.500	.750	12.126	.937	11.814	1.093	11.500	1.250	11.188	1.406
16	16.000	14.688	.656	14.314	.843	13.938	1.031	13.564	1.218	13.124	1.438	12.814	1.593
18	18.000	16.500	.750	16.126	.937	15.688	1.156	15.250	1.375	14.876	1.562	14.438	1.781
20	20.000	18.376	.812	17.938	1.031	17.438	1.281	17.000	1.500	16.500	1.750	16.064	1.968
22	22.000	20.250	.875	19.750	1.125	19.250	1.375	18.750	1.625	18.250	1.875	17.750	2.125
24	24.000	22.064	.968	21.564	1.218	20.938	1.531	20.376	1.812	19.876	2.062	19.314	2.343

Cast Iron Pipe - ASA Standard

Pipe Size	Pipe O.D.	Class 50		Class 100		Class 150		Class 200		Class 250		Class 300		Class 350	
		WALL	I.D.	WALL	I.D.	WALL	I.D.	WALL	I.D.	WALL	I.D.	WALL	I.D.	WALL	I.D.
3	3.96	0.32	3.32	0.32	3.32	0.32	3.32	0.32	3.32	0.32	3.32	0.32	3.32	0.32	3.32
4	4.80	0.35	4.10	0.35	4.10	0.35	4.10	0.35	4.10	0.35	4.10	0.35	4.10	0.35	4.10
6	6.90	0.38	6.14	0.38	6.14	0.38	6.14	0.38	6.14	0.38	6.14	0.38	6.14	0.38	6.14
8	9.05	0.41	8.23	0.41	8.23	0.41	8.23	0.41	8.23	0.41	8.23	0.41	8.23	0.41	8.23
10	11.10	0.44	10.22	0.44	10.22	0.44	10.22	0.44	10.22	0.44	10.22	0.48	10.14	0.52	10.06
12	13.20	0.48	12.24	0.48	12.24	0.48	12.24	0.48	12.24	0.52	12.16	0.52	12.16	0.56	12.08
14	15.30	0.48	14.34	0.51	14.28	0.51	14.28	0.55	14.20	0.59	14.12	0.59	14.12	0.64	14.02
16	17.40	0.54	16.32	0.54	16.32	0.54	16.32	0.58	16.24	0.63	16.14	0.68	16.04	0.68	16.04
18	19.50	0.54	18.42	0.58	18.34	0.58	18.34	0.63	18.24	0.68	18.14	0.73	18.04	0.79	17.92
20	21.60	0.57	20.46	0.62	20.36	0.62	20.36	0.67	20.26	0.72	20.16	0.78	20.04	0.84	19.92
24	25.80	0.63	24.54	0.68	24.44	0.73	24.34	0.79	24.22	0.79	24.22	0.85	24.10	0.92	23.96

Cast Iron Pipe - AWWA Standard

Pipe Size	Class A 100 Ft. 43 PSIG			Class B 200 Ft. 86 PSIG			Class C 300 Ft. 130 PSIG			Class D 400 Ft. 173 PSIG		
	O.D.	WALL	I.D.	O.D.	WALL	I.D.	O.D.	WALL	I.D.	O.D.	WALL	I.D.
3	3.80	0.39	3.02	3.96	0.42	3.12	3.96	0.45	3.06	3.96	0.48	3.00
4	4.80	0.42	3.96	5.00	0.45	4.10	5.00	0.48	4.04	5.00	0.52	3.96
6	6.90	0.44	6.02	7.10	0.48	6.14	7.10	0.51	6.08	7.10	0.55	6.00
8	9.05	0.46	8.13	9.05	0.51	8.03	9.30	0.56	8.18	9.30	0.60	8.10
10	11.10	0.50	10.10	11.10	0.57	9.96	11.40	0.62	10.16	11.40	0.68	10.04
12	13.20	0.54	12.12	13.20	0.62	11.96	13.50	0.68	12.14	13.50	0.75	12.00
14	15.30	0.57	14.16	15.30	0.66	13.98	15.65	0.74	14.17	15.65	0.82	14.01
16	17.40	0.60	16.20	17.40	0.70	16.00	17.80	0.80	16.20	17.80	0.89	16.02
18	19.50	0.64	18.22	19.50	0.75	18.00	19.92	0.87	18.18	19.92	0.96	18.00
20	21.60	0.67	20.26	21.60	0.80	20.00	22.06	0.92	20.22	22.06	1.03	20.00
24	25.80	0.76	24.28	25.80	0.89	24.02	26.32	1.04	24.22	26.32	1.16	24.00
30	31.74	0.88	29.98	32.00	1.03	29.94	32.40	1.20	30.00	32.74	1.37	30.00
36	37.96	0.99	35.98	38.30	1.15	36.00	38.70	1.36	39.98	39.16	1.58	36.00
42	44.20	1.10	42.00	44.50	1.28	41.94	45.10	1.54	42.02	45.58	1.78	42.02
48	50.50	1.26	47.98	50.80	1.42	47.96	51.40	1.71	47.98	51.98	1.96	48.06
54	56.66	1.35	53.96	57.10	1.55	54.00	57.80	1.90	54.00	58.40	2.23	53.94
60	62.80	1.39	60.02	63.40	1.67	60.06	64.20	2.00	60.20	64.82	2.38	60.06
72	75.34	1.62	72.10	76.00	1.95	72.10	76.88	2.39	72.10			
84	87.54	1.72	84.10	88.54	2.22	84.10						

Pipe Size	Class E 500 Ft. 217 PSIG			Class F 600 Ft. 260 PSIG			Class G 700 Ft. 304 PSIG			Class H 800 Ft. 347 PSIG		
	O.D.	WALL	I.D.	O.D.	WALL	I.D.	O.D.	WALL	I.D.	O.D.	WALL	I.D.
6	7.22	0.58	6.06	7.22	0.61	6.00	7.38	0.65	6.08	7.38	0.69	6.00
8	9.42	0.66	8.10	9.42	0.71	8.00	9.60	0.75	8.10	9.60	0.80	8.00
10	11.60	0.74	10.12	11.60	0.80	10.00	11.84	0.86	10.12	11.84	0.92	10.00
12	13.78	0.82	12.14	13.78	0.89	12.00	14.08	0.97	12.14	14.08	1.04	12.00
14	15.98	0.90	14.18	15.98	0.99	14.00	16.32	1.07	14.18	16.32	1.16	14.00
16	18.16	0.98	16.20	18.16	1.08	16.00	18.54	1.18	16.18	18.54	1.27	16.00
18	20.34	1.07	18.20	20.34	1.17	18.00	20.78	1.28	18.22	20.78	1.39	18.00
20	22.54	1.15	20.24	22.54	1.27	20.00	23.02	1.39	20.24	23.02	1.51	20.00
24	26.90	1.31	24.28	26.90	1.45	24.00	27.76	1.75	24.26	27.76	1.88	24.00
30	33.10	1.55	30.00	33.46	1.73	30.00						
36	39.60	1.80	36.00	40.04	2.02	36.00						

Copper Tubing

Pipe	K			L			M			Copper & Brass Pipe			Aluminum		
Size	O.D.	I.D.	WALL	O.D.	I.D.	WALL	O.D.	I.D.	WALL	O.D.	I.D.	WALL	O.D.	I.D.	WALL
½"	0.625	0.527	0.049	0.625	0.545	0.040	0.625	0.569	0.028	0.840	0.625	0.108			
⅝"	0.750	0.652	0.049	0.750	0.666	0.042	0.750	0.690	0.030						
¾"	0.875	0.745	0.065	0.875	0.785	0.045	0.875	0.811	0.032	1.050	0.822	0.114			
1"	1.125	0.995	0.065	1.125	1.025	0.050	1.125	1.055	0.035	1.315	1.062	0.127			
1 ¼"	1.375	1.245	0.065	1.375	1.265	0.055	1.375	1.291	0.042	1.660	1.368	0.146			
1 ½"	1.625	1.481	0.072	1.625	1.505	0.060	1.625	1.527	0.049	1.900	1.600	0.150			
2"	2.125	1.959	0.083	2.125	1.985	0.070	2.125	2.009	0.058	2.375	2.062	0.157			
2 ½"	2.625	2.435	0.095	2.625	2.465	0.080	2.625	2.495	0.065	2.875	2.500	0.188	2.500	2.400	0.050
3"	3.125	2.907	0.109	3.125	2.945	0.090	3.125	2.981	0.072	3.500	3.062	0.219	3.000	2.900	0.050
3 ½"	3.625	3.385	0.120	3.625	3.425	0.100	3.625	3.459	0.083	4.000	3.500	0.250			
4"	4.125	3.857	0.134	4.125	3.905	0.110	4.125	3.935	0.095	4.500	3.935	0.095	4.000	4.000	0.250
4 ½"													5.000	4.500	0.250
5"	5.125	4.805	0.160	5.125	4.875	0.125	5.125	4.907	0.109	5.563	5.063	0.250	5.000	4.874	0.063
6"	6.125	5.741	0.192	6.125	5.845	0.140	6.125	5.881	0.122	6.625	6.125	0.250	6.000	5.874	0.063
7"										7.625	7.062	0.282	7.000	6.844	0.078
8"	8.125	7.583	0.271	8.125	7.725	0.200	8.125	7.785	0.170	8.625	8.000	0.313	8.000	7.812	0.094
10"	10.125	9.449	0.338	10.125	9.625	0.250	10.125	9.701	0.212	10.000	9.812	0.094			
12"	12.125	11.315	0.405	12.125	11.565	0.280	12.125	11.617	0.254						

APPENDIX B – Liquid Speed of Sound

Substance	Form Index	Specific Gravity	Sound Speed m/sec.	v/°C - m/s/°C Δ
Acetic anhydride (22)	(CH ₃ CO) ₂ O	1.082 (20°C)	1180	2.5
Acetic acid, anhydride (22)	(CH ₃ CO) ₂ O	1.082 (20°C)	1180	2.5
Acetic acid, nitrile	C ₂ H ₃ N	0.783	1290	4.1
Acetic acid, ethyl ester (33)	C ₄ H ₈ O ₂	0.901	1085	4.4
Acetic acid, methyl ester	C ₃ H ₆ O ₂	0.934	1211	
Acetone	C ₃ H ₆ O	0.791	1174	4.5
Acetonitrile	C ₂ H ₃ N	0.783	1290	4.1
Acetylacetone	C ₆ H ₁₀ O ₂	0.729	1399	3.6
Acetylene dichloride	C ₂ H ₂ Cl ₂	1.26	1015	3.8
Acetylene tetrabromide (47)	C ₂ H ₂ Br ₄	2.966	1027	
Acetylene tetrachloride (47)	C ₂ H ₂ Cl ₄	1.595	1147	
Alcohol	C ₂ H ₆ O	0.789	1207	4.0
Alkazene-13	C ₁₅ H ₂₄	0.86	1317	3.9
Alkazene-25	C ₁₀ H ₁₂ Cl ₂	1.20	1307	3.4
2-Amino-ethanol	C ₂ H ₇ NO	1.018	1724	3.4
2-Aminotolidine (46)	C ₇ H ₉ N	0.999 (20°C)	1618	
4-Aminotolidine (46)	C ₇ H ₉ N	0.966 (45°C)	1480	
Ammonia (35)	NH ₃	0.771	1729	6.68
Amorphous Polyolefin		0.98	962.6	
t-Amyl alcohol	C ₅ H ₁₂ O	0.81	1204	
Aminobenzene (41)	C ₆ H ₅ NO ₂	1.022	1639	4.0
Aniline (41)	C ₆ H ₅ NO ₂	1.022	1639	4.0
Argon (45)	Ar	1.400 (-188°C)	853	
Azine	C ₆ H ₅ N	0.982	1415	4.1
Benzene (29,40,41)	C ₆ H ₆	0.879	1306	4.65
Benzol(29,40,41)	C ₆ H ₆	0.879	1306	4.65
Bromine (21)	Br ₂	2.928	889	3.0
Bromo-benzene (46)	C ₆ H ₅ Br	1.522	1170	
1-Bromo-butane (46)	C ₄ H ₉ Br	1.276 (20°C)	1019	
Bromo-ethane (46)	C ₂ H ₅ Br	1.460 (20°C)	900	
Bromoform (46,47)	CHBr ₃	2.89 (20°C)	918	3.1
n-Butane (2)	C ₄ H ₁₀	0.601 (0°C)	1085	5.8
2-Butanol	C ₄ H ₁₀ O	0.81	1240	3.3
sec-Butylalcohol	C ₄ H ₁₀ O	0.81	1240	3.3
n-Butyl bromide (46)	C ₄ H ₉ Br	1.276 (20°C)	1019	
n-Butyl chloride (22,46)	C ₄ H ₉ Cl	0.887	1140	4.57
tert Butyl chloride	C ₄ H ₉ Cl	0.84	984	4.2
Butyl oleate	C ₂₂ H ₄₂ O ₂		1404	3.0
2,3 Butylene glycol	C ₄ H ₁₀ O ₂	1.019	1484	1.51
Cadmium (7)	Cd		2237.7	
Carbinol (40,41)	CH ₄ O	0.791 (20°C)	1076	2.92
Carbitol	C ₆ H ₁₄ O ₃	0.988	1458	
Carbon dioxide (26)	CO ₂	1.101 (-37°C)	839	7.71
Carbon disulphide	CS ₂	1.261 (22°C)	1149	
Carbon tetrachloride(33,35,47)	CCl ₄	1.595 (20°C)	926	2.48

Substance	Form Index	Specific Gravity	Sound Speed m/sec.	v/°C - m/s/°C Δ
Carbon tetrafluoride (14)	CF ₄	1.75 (-150°C)	875.2	6.61
Cetane (23)	C ₁₆ H ₃₄	0.773 (20°C)	1338	3.71
Chloro-benzene	C ₆ H ₅ Cl	1.106	1273	3.6
1-Chloro-butane (22,46)	C ₄ H ₉ Cl	0.887	1140	4.57
Chloro-diFluoromethane (3) (Freon 22)	CHClF ₂	1.491 (-69°C)	893.9	4.79
Chloroform (47)	CHCl ₃	1.489	979	3.4
1-Chloro-propane (47)	C ₃ H ₇ Cl	0.892	1058	
Chlorotrifluoromethane (5)	CClF ₃		724	5.26
Cinnamaldehyde	C ₉ H ₈ O	1.112	1554	3.2
Cinnamic aldehyde	C ₉ H ₈ O	1.112	1554	3.2
Colamine	C ₂ H ₇ NO	1.018	1724	3.4
o-Cresol (46)	C ₇ H ₈ O	1.047 (20°C)	1541	
m-Cresol (46)	C ₇ H ₈ O	1.034 (20°C)	1500	
Cyanomethane	C ₂ H ₃ N	0.783	1290	4.1
Cyclohexane (15)	C ₆ H ₁₂	0.779 (20°C)	1248	5.41
Cyclohexanol	C ₆ H ₁₂ O	0.962	1454	3.6
Cyclohexanone	C ₆ H ₁₀ O	0.948	1423	4.0
Decane (46)	C ₁₀ H ₂₂	0.730	1252	
1-Decene (27)	C ₁₀ H ₂₀	0.746	1235	4.0
n-Decylene (27)	C ₁₀ H ₂₀	0.746	1235	4.0
Diacetyl	C ₄ H ₆ O ₂	0.99	1236	4.6
Diamylamine	C ₁₀ H ₂₃ N		1256	3.9
1,2 Dibromo-ethane (47)	C ₂ H ₄ Br ₂	2.18	995	
trans-1,2-Dibromoethene(47)	C ₂ H ₂ Br ₂	2.231	935	
Dibutyl phthalate	C ₈ H ₂₂ O ₄		1408	
Dichloro-t-butyl alcohol	C ₄ H ₈ Cl ₂ O		1304	3.8
2,3 Dichlorodioxane	C ₂ H ₆ Cl ₂ O ₂		1391	3.7
Dichlorodifluoromethane (3) (Freon 12)	CCl ₂ F ₂	1.516 (-40°C)	774.1	4.24
1,2 Dichloro ethane (47)	C ₂ H ₄ Cl ₂	1.253	1193	
cis 1,2-Dichloro-Ethene(3,47)	C ₂ H ₂ Cl ₂	1.284	1061	
trans 1,2-Dichloro-ethene(3,47)	C ₂ H ₂ Cl ₂	1.257	1010	
Dichloro-fluoromethane (3) (Freon 21)	CHCl ₂ F	1.426 (0°C)	891	3.97
1-2-Dichlorohexafluoro cyclobutane (47)	C ₄ Cl ₂ F ₆	1.654	669	
1-3-Dichloro-isobutane	C ₄ H ₈ Cl ₂	1.14	1220	3.4
Dichloro methane (3)	CH ₂ Cl ₂	1.327	1070	3.94
1,1-Dichloro-1,2,2,2 tetra fluoroethane	CClF ₂ -CClF ₂	1.455	665.3	3.73
Diethyl ether	C ₄ H ₁₀ O	0.713	985	4.87
Diethylene glycol, monoethyl ether	C ₆ H ₁₄ O ₃	0.988	1458	
Diethylenimide oxide	C ₄ H ₉ NO	1.00	1442	3.8
1,2-bis(DiFluoramino) butane (43)	C ₄ H ₈ (NF ₂) ₂	1.216	1000	
1,2bis(DiFluoramino)- 2-methylpropane (43)	C ₄ H ₉ (NF ₂) ₂	1.213	900	
1,2bis(DiFluoramino) propane (43)	C ₃ H ₆ (NF ₂) ₂	1.265	960	
2,2bis(DiFluoramino) propane (43)	C ₃ H ₆ (NF ₂) ₂	1.254	890	
2,2-Dihydroxydiethyl ether	C ₄ H ₁₀ O ₃	1.116	1586	2.4

Substance	Form Index	Specific Gravity	Sound Speed m/sec.	v/°C - m/s/°C Δ
Dihydroxyethane	C ₂ H ₆ O ₂	1.113	1658	2.1
1,3-Dimethyl-benzene (46)	C ₈ H ₁₀	0.868 (15°C)	1343	
1,2-1.0Dimethyl-benzene(29,46)	C ₈ H ₁₀	0.897 (20°C)	1331.5	4.1
1,4-Dimethyl-benzene (46)	C ₈ H ₁₀		1334	
2,2-Dimethyl-butane (29,33)	C ₆ H ₁₄	0.649 (20°C)	1079	
Dimethyl ketone	C ₃ H ₆ O	0.791	1174	4.5
Dimethyl pentane (47)	C ₇ H ₁₆	0.674	1063	
Dimethyl phthalate	C ₈ H ₁₀ O ₄	1.2	1463	
Diiodo-methane	CH ₂ I ₂	3.235	980	
Dioxane	C ₄ H ₈ O ₂	1.033	1376	
Dodecane (23)	C ₁₂ H ₂₆	0.749	1279	3.85
1,2-Ethanediol	C ₂ H ₆ O ₂	1.113	1658	2.1
Ethananitrile	C ₂ H ₃ N	0.783	1290	
Ethanoic anhydride (22)	(CH ₃ CO) ₂ O	1.082	1180	
Ethanol	C ₂ H ₆ O	0.789	1207	4.0
Ethanol amide	C ₂ H ₇ NO	1.018	1724	3.4
Ethoxyethane	C ₄ H ₁₀ O	0.713	985	4.87
Ethyl acetate (33)	C ₄ H ₈ O ₂	0.901	1085	4.4
Ethyl alcohol	C ₂ H ₆ O	0.789	1207	4.0
Ethyl benzene (46)	C ₈ H ₁₀	0.867(20°C)	1338	
Ethyl bromide (46)	C ₂ H ₅ Br	1.461 (20°C)	900	
Ethyl iodide (46)	C ₂ H ₅ I	1.950 (20°C)	876	
Ether	C ₄ H ₁₀ O	0.713	985	4.87
Ethyl ether	C ₄ H ₁₀ O	0.713	985	4.87
Ethylene bromide (47)	C ₂ H ₄ Br ₂	2.18	995	
Ethylene chloride (47)	C ₂ H ₄ Cl ₂	1.253	1193	
Ethylene glycol	C ₂ H ₆ O ₂	1.113	1658	2.1
50% Glycol/ 50% H ₂ O			1578	
d-Fenochone	C ₁₀ H ₁₆ O	0.947	1320	
d-2-Fenecanone	C ₁₀ H ₁₆ O	0.947	1320	
Fluorine	F	0.545 (-143°C)	403	11.31
Fluoro-benzene (46)	C ₆ H ₅ F	1.024 (20°C)	1189	
Formaldehyde, methyl ester	C ₂ H ₄ O ₂	0.974	1127	4.02
Formamide	CH ₃ NO	1.134 (20°C)	1622	2.2
Formic acid, amide	CH ₃ NO	1.134 (20°C)	1622	
Freon R12			774	
Furfural	C ₅ H ₄ O ₂	1.157	1444	
Furfuryl alcohol	C ₅ H ₆ O ₂	1.135	1450	3.4
Fural	C ₅ H ₄ O ₂	1.157	1444	3.7
2-Furaldehyde	C ₅ H ₄ O ₂	1.157	1444	3.7
2-Furancarboxaldehyde	C ₅ H ₄ O ₂	1.157	1444	3.7
2-Furyl-Methanol	C ₅ H ₆ O ₂	1.135	1450	3.4
Gallium	Ga	6.095	2870 (@30°C)	
Glycerin	C ₃ H ₈ O ₃	1.26	1904	2.2

Substance	Form Index	Specific Gravity	Sound Speed m/sec.	v/°C - m/s/°C Δ
Glycerol	C ₃ H ₈ O ₃	1.26	1904	2.2
Glycol	C ₂ H ₆ O ₂	1.113	1658	2.1
Helium (45)	He ₄	0.125(-268.8°C)	183	
Heptane (22,23)	C ₇ H ₁₆	0.684 (20°C)	1131	4.25
n-Heptane (29,33)	C ₇ H ₁₆	0.684 (20°C)	1180	4.0
Hexachloro-Cyclopentadiene(47)	C ₅ Cl ₆	1.7180	1150	
Hexadecane (23)	C ₁₆ H ₃₄	0.773 (20°C)	1338	3.71
Hexalin	C ₆ H ₁₂ O	0.962	1454	3.6
Hexane (16,22,23)	C ₆ H ₁₄	0.659	1112	2.71
n-Hexane (29,33)	C ₆ H ₁₄	0.649 (20°C)	1079	4.53
2,5-Hexanedione	C ₆ H ₁₀ O ₂	0.729	1399	3.6
n-Hexanol	C ₆ H ₁₄ O	0.819	1300	3.8
Hexahydrobenzene (15)	C ₆ H ₁₂	0.779	1248	5.41
Hexahydrophenol	C ₆ H ₁₂ O	0.962	1454	3.6
Hexamethylene (15)	C ₆ H ₁₂	0.779	1248	5.41
Hydrogen (45)	H ₂	0.071 (-256°C)	1187	
2-Hydroxy-toluene (46)	C ₇ H ₈ O	1.047 (20°C)	1541	
3-Hydroxy-toluene (46)	C ₇ H ₈ O	1.034 (20°C)	1500	
Iodo-benzene (46)	C ₆ H ₅ I	1.823	1114	
Iodo-ethane (46)	C ₂ H ₅ I	1.950 (20°C)	876	
Iodo-methane	CH ₃ I	2.28 (20°C)	978	
Isobutyl acetate (22)	C ₆ H ₁₂ O		1180	4.85
Isobutanol	C ₄ H ₁₀ O	0.81 (20°C)	1212	
Iso-Butane			1219.8	
Isopentane (36)	C ₅ H ₁₂	0.62 (20°C)	980	4.8
Isopropanol (46)	C ₃ H ₈ O	0.785 (20°C)	1170	
Isopropyl alcohol (46)	C ₃ H ₈ O	0.785 (20°C)	1170	
Kerosene		0.81	1324	3.6
Ketohexamethylene	C ₆ H ₁₀ O	0.948	1423	4.0
Lithium fluoride (42)	LiF		2485	1.29
Mercury (45)	Hg	13.594	1449	
Mesityloxiide	C ₆ H ₁₆ O	0.85	1310	
Methane (25,28,38,39)	CH ₄	0.162	405(-89.15°C)	17.5
Methanol (40,41)	CH ₄ O	0.791 (20°C)	1076	2.92
Methyl acetate	C ₃ H ₆ O ₂	0.934	1211	
o-Methylaniline (46)	C ₇ H ₉ N	0.999 (20°C)	1618	
4-Methylaniline (46)	C ₇ H ₉ N	0.966 (45°C)	1480	
Methyl alcohol (40,44)	CH ₄ O	0.791 (20°C)	1076	2.92
Methyl benzene (16,52)	C ₇ H ₈	0.867	1328	4.27
2-Methyl-butane (36)	C ₅ H ₁₂	0.62 (20°C)	980	
Methyl carbinol	C ₂ H ₆ O	0.789	1207	4.0
Methyl-chloroform (47)	C ₂ H ₃ Cl ₃	1.33	985	
Methyl-cyanide	C ₂ H ₃ N	0.783	1290	
3-Methyl cyclohexanol	C ₇ H ₁₄ O	0.92	1400	

Substance	Form Index	Specific Gravity	Sound Speed m/sec.	v/°C - m/s/°C Δ
Methylene chloride (3)	CH ₂ Cl ₂	1.327	1070	3.94
Methylene iodide	CH ₂ I ₂	3.235	980	
Methyl formate (22)	C ₂ H ₄ O ₂	0.974 (20°C)	1127	4.02
Methyl iodide	CH ₃ I	2.28 (20°C)	978	
2-Methylphenol (46)	C ₇ H ₈ O	1.047 (20°C)	1541	
3-Methylphenol (46)	C ₇ H ₈ O	1.034 (20°C)	1500	
Milk, homogenized			1548	
Morpholine	C ₄ H ₉ NO	1.00	1442	3.8
Naphtha		0.76	1225	
Natural Gas (37)		0.316 (-103°C)	753	
Neon (45)	Ne	1.207 (-246°C)	595	
Nitrobenzene (46)	C ₆ H ₅ NO ₂	1.204 (20°C)	1415	
Nitrogen (45)	N ₂	0.808 (-199°C)	962	
Nitromethane (43)	CH ₃ NO ₂	1.135	1300	4.0
Nonane (23)	C ₉ H ₂ O	0.718 (20°C)	1207	4.04
1-Nonene (27)	C ₉ H ₁₈	0.736 (20°C)	1207	4.0
Octane (23)	C ₈ H ₁₈	0.703	1172	4.14
n-Octane (29)	C ₈ H ₁₈	0.704 (20°C)	1212.5	3.50
1-Octene (27)	C ₈ H ₁₆	0.723 (20°C)	1175.5	4.10
Oil of Camphor Sassafrassy			1390	3.8
Oil, Car (SAE 20a.30)	1.74		870	
Oil, Castor	C ₁₁ H ₁₀ O ₁₀	0.969	1477	3.6
Oil, Diesel		0.80	1250	
Oil, Fuel AA gravity		0.99	1485	3.7
Oil (Lubricating X200)			1530	5019.9
Oil (Olive)		0.912	1431	2.75
Oil (Peanut)		0.936	1458	
Oil (Sperm)		0.88	1440	
Oil, 6			1509	
2,2-Oxydiethanol	C ₄ H ₁₀ O ₃	1.116	1586	2.4
Oxygen (45)	O ₂	1.155 (-186°C)	952	
Pentachloro-ethane (47)	C ₂ HCl ₅	1.687	1082	
Pentalin (47)	C ₂ HCl ₅	1.687	1082	
Pentane (36)	C ₅ H ₁₂	0.626 (20°C)	1020	
n-Pentane (47)	C ₅ H ₁₂	0.557	1006	
Perchlorocyclopentadiene(47)	C ₅ Cl ₆	1.718	1150	
Perchloro-ethylene (47)	C ₂ Cl ₄	1.632	1036	
Perfluoro-1-Hepten (47)	C ₇ F ₁₄	1.67	583	
Perfluoro-n-Hexane (47)	C ₆ F ₁₄	1.672	508	
Phene (29,40,41)	C ₆ H ₆	0.879	1306	4.65
β-Phenyl acrolein	C ₉ H ₈ O	1.112	1554	3.2
Phenylamine (41)	C ₆ H ₅ NO ₂	1.022	1639	4.0
Phenyl bromide (46)	C ₆ H ₅ Br	1.522	1170	

Substance	Form Index	Specific Gravity	Sound Speed m/sec.	v/°C - m/s/°C Δ
Phenyl chloride	C ₆ H ₅ Cl	1.106	1273	3.6
Phenyl iodide (46)	C ₆ H ₅ I	1.823	1114	
Phenyl methane (16,52)	C ₇ H ₈	0.867 (20°C)	1328	4.27
3-Phenyl propanal	C ₉ H ₈ O	1.112	1554	3.2
Phthalardione	C ₈ H ₄ O ₃		1125	
Phthalic acid, anhydride	C ₈ H ₄ O ₃		1125	
Phthalic anhydride	C ₈ H ₄ O ₃		1125	
Pimelic ketone	C ₆ H ₁₀ O	0.948	1423	4.0
Plexiglas, Lucite, Acrylic			2651	
Polyterpene Resin		0.77	1099.8	
Potassium bromide (42)	Kbr		1169	0.71
Potassium fluoride (42)	KF		1792	1.03
Potassium iodide (42)	KI		985	0.64
Potassium nitrate (48)	KNO ₃	1.859 (352°C)	1740.1	1.1
Propane (2,13)(-45 to -130°C)	C ₃ H ₈	0.585 (-45°C)	1003	5.7
1,2,3-Propanetriol	C ₃ H ₈ O ₃	1.26	1904	2.2
1-Propanol (46)	C ₃ H ₈ O	0.78 (20°C)	1222	
2-Propanol (46)	C ₃ H ₈ O	0.785 (20°C)	1170	
2-Propanone	C ₃ H ₆ O	0.791	1174	4.5
Propene (17,18,35)	C ₃ H ₆	0.563 (-13°C)	963	6.32
n-Propyl acetate (22)	C ₅ H ₁₀ O ₂	1280 (2°C)	4.63	
n-Propyl alcohol	C ₃ H ₈ O	0.78 (20°C)	1222	
Propylchloride (47)	C ₃ H ₇ Cl	0.892	1058	
Propylene (17,18,35)	C ₃ H ₆	0.563 (-13°C)	963	6.32
Pyridine	C ₅ H ₅ N	0.982	1415	4.1
Refrigerant 11 (3,4)	CCl ₃ F	1.49	828.3	3.56
Refrigerant 12 (3)	CCl ₂ F ₂	1.516 (-40°C)	774.1	4.24
Refrigerant 14 (14)	CF ₄	1.75 (-150°C)	875.24	6.61
Refrigerant 21 (3)	CHCl ₂ F	1.426 (0°C)	891	3.97
Refrigerant 22 (3)	CHClF ₂	1.491 (-69°C)	893.9	4.79
Refrigerant 113 (3)	CCl ₂ F-CClF ₂	1.563	783.7	3.44
Refrigerant 114 (3)	CClF ₂ -CClF ₂	1.455	665.3	3.73
Refrigerant 115 (3)	C ₂ ClF ₅		656.4	4.42
Refrigerant C318 (3)	C ₄ F ₈	1.62 (-20°C)	574	3.88
Selenium (8)	Se		1072	0.68
Silicone (30 cp)		0.993	990	
Sodium fluoride (42)	NaF	0.877	2082	1.32
Sodium nitrate (48)	NaNO ₃	1.884 (336°C)	1763.3	0.74
Sodium nitrite (48)	NaNO ₂	1.805 (292°C)	1876.8	
Solvesso 3		0.877	1370	3.7
Spirit of wine	C ₂ H ₆ O	0.789	1207	4.0
Sulphur (7,8,10)	S		1177	-1.13
Sulphuric acid (1)	H ₂ SO ₄	1.841	1257.6	1.43
Tellurium (7)	Te		991	0.73

Substance	Form Index	Specific Gravity	Sound Speed m/sec.	v/°C - m/s/°C Δ
1,1,2,2-Tetrabromo-ethane(47)	C ₂ H ₂ Br ₄	2.966120	1027	
1,1,2,2-Tetrachloro-ethane(67)	C ₂ H ₂ Cl ₄	1.595	1147	
Tetrachloroethane (46)	C ₂ H ₂ Cl ₄	1.553 (20°C)	1170	
Tetrachloro-ethene (47)	C ₂ Cl ₄	1.632	1036	
Tetrachloro-methane (33,47)	CCl ₄	1.595 (20°C)	926	
Tetradecane (46)	C ₁₄ H ₃₀	0.763 (20°C)	1331	
Tetraethylene glycol	C ₈ H ₁₈ O ₅	1.123	1586/5203.4	3.0
Tetrafluoro-methane (14) (Freon 14)	CF ₄	1.75 (-150°C)	875.24	6.61
Tetrahydro-1,4-isoxazine	C ₄ H ₉ NO		1442	3.8
Toluene (16,52)	C ₇ H ₈	0.867 (20°C)	1328	4.27
o-Toluidine (46)	C ₇ H ₉ N	0.999 (20°C)	1618	
p-Toluidine (46)	C ₇ H ₉ N	0.966 (45°C)	1480	
Toluol	C ₇ H ₈	0.866	1308	4.2
Tribromo-methane (46,47)	CHBr ₃	2.89 (20°C)	918	
1,1,1-Trichloro-ethane (47)	C ₂ H ₃ Cl ₃	1.33	985	
Trichloro-ethene (47)	C ₂ HCl ₃	1.464	1028	
Trichloro-fluoromethane (3) (Freon 11)	CCl ₃ F	1.49	828.3	3.56
Trichloro-methane (47)	CHCl ₃	1.489	979	3.4
1,1,2-Trichloro-1,2,2-Trifluoro-Ethane	CCl ₂ F-CClF ₂	1.563	783.7	
Triethyl-amine (33)	C ₆ H ₁₅ N	0.726	1123	4.47
Triethylene glycol	C ₆ H ₁₄ O ₄	1.123	1608	3.8
1,1,1-Trifluoro-2-Chloro-2-Bromo-Ethane	C ₂ HClBrF ₃	1.869	693	
1,2,2-Trifluorotrichloro- ethane (Freon 113)	CCl ₂ F-CClF ₂	1.563	783.7	3.44
d-1,3,3-Trimethylnor- camphor	C ₁₀ H ₁₆ O	0.947	1320	
Trinitrotoluene (43)	C ₇ H ₅ (NO ₂) ₃	1.64	1610	
Turpentine		0.88	1255	
Unisis 800		0.87	1346	
Water, distilled (49,50)	H ₂ O	0.996	1498	-2.4
Water, heavy	D ² O		1400	
Water, sea		1.025	1531	-2.4
Wood Alcohol (40,41)	CH ₄ O	0.791 (20°C)	1076	2.92
Xenon (45)	Xe		630	
m-Xylene (46)	C ₈ H ₁₀	0.868 (15°C)	1343	
o-Xylene (29,46)	C ₈ H ₁₀	0.897 (20°C)	1331.5	4.1
p-Xylene (46)	C ₈ H ₁₀		1334	
Xylene hexafluoride	C ₈ H ₄ F ₆	1.37	879	
Zinc (7)	Zn		3298	