



FlowCERT

Instruction Manual



FLOWCERT (FOURTH EDITION REV 5)

March 2024

Part Number M-150-0-004-5P

COPYRIGHT

© Pulsar Measurement, 2005 -24. All rights reserved. No part of this publication may be reproduced, transmitted, transcribed, stored in a retrieval system, or translated into any language in any form without the written permission of Pulsar Measurement.

WARRANTY AND LIABILITY

Pulsar Measurement guarantee for a period of 2 years from the date of delivery that it will either exchange or repair any part of this product returned to Pulsar Measurement if it is found to be defective in material or workmanship, subject to the defect not being due to unfair wear and tear, misuse, modification or alteration, accident, misapplication, or negligence.

DISCLAIMER

Pulsar Measurement neither gives nor implies any process guarantee for this product and shall have no liability in respect of any loss, injury or damage whatsoever arising out of the application or use of any product or circuit described herein.

Every effort has been made to ensure accuracy of this documentation, but Pulsar Measurement cannot be held liable for any errors.

Pulsar Measurement operates a policy of constant development and improvement and reserves the right to amend technical details, as necessary.

The FlowCERT shown on the cover of this manual is used for illustrative purposes only and may not be representative of the actual FlowCERT supplied.

CONTACT

For technical support, please contact:

Europe: supporteurope@pulsarmeasurement.com

Outside Europe: supportnorthamerica@pulsarmeasurement.com

If you have any comments or suggestions about this product, please contact:

Europe: europe@pulsarmeasurement.com

Outside Europe: northamerica@pulsarmeasurement.com

Pulsar Measurement website: www.pulsarmeasurement.com

United States

11451 Belcher Road South
Largo,
FL 33773
888-473-9546

Canada

16456 Sixsmith Drive
Long Sault, Ont.
K0C 1P0
855-300-9151

United Kingdom

Cardinal Building, Enigma
Commercial Centre
Sandy's Road, Malvern
WR14 1JJ
00 44 (0)1684 89137

CONTENTS

Chapter 1: Start Here.....	11
About this Manual	11
About the FlowCERT	12
Functional Description	13
Product Specification.....	15
EU Certificate of Conformity.....	19
Chapter 2 FlowCERT Installation.....	20
Unpacking	20
Power Supply Requirements.....	20
Location	20
Dimensions	22
Wall Mount.....	22
Cable Entry.....	24
Terminal connection details.....	24
Terminal connections	24
Transducer	25
ATEX	25
FM	25
Voltage Selector and Fuse Location	27
Preparation for Operation	28
Maintenance	28
Chapter 3 DUET transducer	29
DUET Transducer.....	29
Dimensions	31
Mounting Plate	32
Fixings.....	32
Fitting Options	33
Chapter 4 Velocity Sensors	34
Functional Description	34
Speedy.....	34

MicroFlow.....	35
Limitations of use.....	35
Technical Data	36
Speedy Dimensions.....	36
MicroFlow Dimensions.....	37
Mounting.....	38
Angled Mounting Bracket.....	38
Mounting sensor to a bracket.....	40
Velocity sensor warranty and liability	42
Velocity sensor wiring details.....	42
Installation of Speedy Sensor.....	44
Limitation of Performance.....	44
Positioning of the Speedy Sensor	45
Distance from valves and slide gates.....	46
Flumes and Channels.....	48
Positioning of the MicroFlow sensor.....	50
Hazardous Area Installation.....	51
Installing the sensor	54
Preparation for Operation	55
General Maintenance	55
Operation and Parameters	56
Communications and recovery.....	58
Maintenance	59
Chapter 5 How To Use Your FlowCERT	60
Operating the Controls.....	60
Run Mode.....	61
Program Mode.....	62
How to Access Program Mode.....	62
Hot Keys.....	63

Menu Keys 64

Numeric Keys..... 64

Using the Menu System 65

 Directly Editing Parameters 66

Test Mode 67

Using the Serial Interface 68

Parameter Defaults 70

Chapter 6 Quick Setup Guide 71

 Enter Program Mode 71

 Choose Quick Setup..... 71

 Choose Your Application 72

 Quick Setup 74

 Exponential Devices (P700 = 1) 78

 Point of Measurement 79

 Calculations 81

 Example 1 V-Notch Weir..... 83

 BS3680 Flumes (P700 = 2)..... 85

 Calculations 86

 Rectangular Flume 86

 U-Throated Flume..... 87

 Example 2 BS3680 U-Throated Flume 88

 BS3680 Weirs (P700 = 3)..... 90

 Calculations 90

 BS3680 Rectangular Weir 90

 BS3680 V-Notch Weir..... 91

 Example 3 BS3680 Rectangular Weir 92

 BS3680 Rectangular Broad Crested Weir 94

 Calculations 94

 Area Velocity 96

 Calculations 97

Special Devices (P700 =5).....	100
Calculations	101
Universal Calculations (P700=6).....	102
Calculations	102
Chapter 7 Parameter Guide	104
Menu System	104
Top Level Menu	104
Application Menu.....	105
Relays Menu	106
Data Logs Menu	107
OCM Menu	108
OCM Menu When P130 = 2 (Velocity)	109
Display Menu	110
mA Output 1 Menu	111
mA Output 2 Menu	111
Compensation	112
Stability Menu	112
Echo Processing Menu.....	113
System Menu	114
Device Comm Menu	115
Test Menu	116
Chapter 8 Parameter Listing and Description	117
Application Parameters.....	117
Operation	117
Dimensions	118
mA Input.....	120
Relay Parameters.....	122
Alarms.....	123
Pumps.....	127

Control.....131

Miscellaneous133

Common Relay parameters.....135

Data Log parameters136

Totaliser Audits136

Temperature.....136

OCM Parameters137

PMD Setup.....137

Dimensions143

Calculations148

Device mode = Velocity149

Breakpoints.....152

Tables.....153

Average Flow153

Display Parameters.....154

Options.....154

Failsafe.....155

Auxiliary.....156

Totaliser.....158

Bargraph160

mA Output 1 Parameters160

Range.....160

Operation161

Setpoint.....161

Limits.....162

Trim.....162

Failsafe.....163

Allocation163

mA Output 2 Parameters164

Range.....164

Operation	165
Setpoint.....	165
Limits.....	166
Trim.....	166
Failsafe.....	167
Allocation	167
Compensation Parameters	168
Offset.....	168
Temperature.....	168
Velocity.....	169
Stability Parameters	169
Damping	169
Indicator.....	169
Rate.....	170
Filters.....	171
Echo Processing Parameters.....	172
Transducer 1 Status.....	172
System Parameters	173
Passcode	173
Backup	173
System Information	174
Date & Time	175
LED Colour	175
Watchdog.....	176
Daylight Saving Time.....	177
Device Comm.	181
RS232 Set Up	181
RS 485 Set Up.....	182
Remote Alarm.....	183

FLOWCERT INSTRUCTION MANUAL

Test Parameters	185
Simulation	185
Hardware	187
Chapter 9 Troubleshooting.....	189
Chapter 10 Disposal.....	190
Notes	191

CHAPTER 1: START HERE...

Congratulations on your purchase of a Pulsar FlowCERT. This quality system has been developed over many years and represents the latest in high technology ultrasonic level measurement and control.

It has been designed to give you years of trouble-free performance, and a few minutes spent reading this operating manual will ensure that your installation is as simple as possible.

About this Manual

It is important that this manual is referred to for correct installation and operation. There are various parts of the manual that offer additional help or information as shown.

Tips



TIP: Look for this icon throughout your Pulsar Measurement manual to find helpful information and answers to frequently asked questions.

Additional Information

Additional Information

At various parts of the manual, you will find sections like this that explain specific things in more detail.

References

See Also

References to other parts of the manual.

About the FlowCERT

The FlowCERT open channel flow meter is a brand-new concept in ultrasonic flow metering, incorporating the latest temperature compensation techniques. The FlowCERT provides comprehensive flow monitoring with data logging and control functions for a complete range of flumes, weirs and channels with provision for using a velocity sensor input to enable calculation of flow through channels where no primary measuring element is present. Utilizing the DUET transducer, a revolutionary concept in solar radiation compensation, the FlowCERT can compensate for temperature variation based upon changes in the speed of sound through air rather than relying on traditional temperature sensors that often absorb solar radiation to give an inaccurate temperature reading.



Easy calibration and maintenance free “fit and forget” performance mean that you can install the FlowCERT rapidly and with confidence. There are Five user-definable relays enabling initiation of control or indication devices such as pumps, samplers, and remote totalizers whilst local indication of flow and total flow is provided by a back lit LCD display with bar graph.

The FlowCERT is by far the most versatile open channel flow monitor on the market today.

Functional Description

The FlowCERT is non-contacting and operates on the principle of timing the echo received from a pulse of sound in air, when used with the revolutionary new DUET (Double Ultrasonic Echo Transducer) transducer this provides a highly accurate calculation of flow, from the measured head preceding the primary element.

Pulsar's DUET is a completely new concept, employing two separate ultrasonic transducers mounted at different heights above the measured head within the Primary Measurement Device (PMD). Both transducers emit sound pulses synchronously and the returning echoes are analyzed in the FlowCERT discriminating between the two signals so the time difference can be calculated extremely accurately. All other effects, including temperature, are irrelevant and can be eliminated. The FlowCERT then uses this knowledge to dynamically calculate the distance to the liquid surface resulting in accuracy which has never been seen before.

Flow calculations to the British Standard BS3680 are available within the software together with calculations for a wide variety of other primary elements. Also available within the unit is a customized 32-point calibration routine which also permits the flow measurement of non - standard flumes and weirs. For channels without primary elements the FlowCERT even offers the option of connecting a Speedy or MicroFlow Velocity Sensor and performing the calculations of Flow (Q) = Velocity x area for a wide variety of channel shapes.

The FlowCERT utilises the unique DATEM software (Digital Adaptive Tracking of Echo Movement). This is a proven digital mapping technique developed especially for the Pulsar ultra range. It gives the system edge when identifying the "true target level" in the face of competing echoes from such things as pipes or other obstructions.

The FlowCERT can measure from zero to 49.213feet (16m) from the transducer to the surface being monitored, dependent on the transducer used.

The FlowCERT can show level, space, distance, head, or flow on the display. The relays can be programmed to activate alarms, pump starters, or other control equipment. There are two isolated 4-20 mA outputs that can be connected to a chart recorder or PLC, to monitor level, space, or distance, independently from that shown on the display. There is an RJ11 port which allows an RS232 serial interface, so that the FlowCERT can be operated remotely by a PC or other equipment.

The FlowCERT can be programmed either by the built-in keypad or by PC via the RS 232 Serial Interface (optional). All the parameters are stored in non-volatile memory, so are retained in the event of power interruption. A second backup copy of all parameters can also be retained in the FlowCERT, in case a previous set of parameters needs to be restored.

Product Specification

PHYSICAL

Wall Mount Outside Dimensions	235 x 184 x 120 mm (9.25 x 7.24 x 4.72 inch)
Weight	Nominal 1kg (2.2lbs)
Enclosure Material/Description	Polycarbonate, flame resistant to UL94-5V
Cable Entry Detail	10 cable entry knock outs, 1 x M16, 5 x M20 underside, 4 x 18mm dia (PG11) at rear
Transducer Cable Extensions	3 conductor 20AWG screened
Maximum Separation	1000m(3,280 ft), 500m (1,640 ft) for mmWave

ENVIRONMENTAL

IP Rating (Wall)	IP65 (NEMA 4X), IP20 when open
Max. & min. temperature (electronics)	-20 °C to +50 °C (-4°F to +120°F)
Altitude	2,000m (6,561 ft)
Flammable atmosphere approval	Safe area: compatible with approved dB transducers (see transducer spec' sheet)
CE Approval	See EU Declaration of Conformity

PERFORMANCE

Accuracy	Dependent on application and sensor used, typically with standard ultrasonic transducer, 0.25% of the measured range or 6 mm (0.24") (whichever is greater). DUET 0.025% of Max. range. mmWAVE ± 2mm.)
Resolution	Dependent on application and sensor used, typically with standard ultrasonic transducer, 0.1% of the measured range or 0.08" (2mm) (whichever is greater). DUET 0.1 mm.
Max. Range	Dependent on application and transducer (maximum 16m (52.49ft) dBR16)
Min. Range	Dependent upon application and transducer (minimum zero dB Mach3)
Rate Response	Fully adjustable

ECHO PROCESSING

Description	DATM (Digital Adaptive Tracking of Echo Movement)
--------------------	---

OUTPUTS

Analogue output (x2)	Isolated (floating) output (to 150V) of 4-20 mA or 0-20 mA into 500Ω (user programmable and adjustable) 1μA resolution
Digital output	Full Duplex RS232
Volt free contacts, number, and rating	5 form "C" (SPDT) rated at 5A at 115V/240V AC
Display	6 digits plus 12-character text, plus bar graph with direction indicators, remote communicator identifier, and program/run/test mode indicators

ANALOG INPUT

0-20 or 4-20 mA	Isolated (floating) input (to 150V) 4-20mA or 0-20 mA source or sink open circuit voltage (source) 33V, 22V at 4mA, 14V at 20Ma (user programmable and adjustable) 0.1%resolution
------------------------	---

VELOCITY INPUT

Velocity sensor	via RS 485 digital communications interface
------------------------	---

PROGRAMMING

On-board programming	By integral keypad
PC programming	Via RS232
Programming security	Via passcode (user selectable and adjustable)
Programmed data integrity	Via non-volatile RAM, plus backup

SUPPLY

Power Supply	115V AC +5% / 10% 50/60 Hz, 230V AC +5% / 10% 50/60 Hz. DC 22-28V 10W maximum power (typically 6W)
Mains Fuse (F1)	125 mA at 115V AC
DC (Battery) (F2)	1A Thermal (self-resetting after power removed). Not user replaceable

Speedy Sensor

PHYSICAL

Dimensions	See Chapter 4 Velocity Sensors for dimensions
Medium Contacting Material	Polyurethane, stainless steel 1.4571 (V4A), PVDF
Cable Type	LiYC11Y 2x1.5 + 1x2x0.34

SUPPLY

Power Supply	DC 8 – 24V. 2.1W power supplied by processor
---------------------	--

ENVIRONMENTAL

IP Rating	IP68
Max and Min Temperature	-20 °C to +50 °C (+40°C in Ex Zone 1)

COMMUNICATION

RS485 proprietary Interface	9600 Baud rate, 8 Bits, 1 Stop bit, no Parity
------------------------------------	---

MISCELLANEOUS

Measurement principal	Ultrasonic continuous wave DOPPLER
Measurement frequency	1 MHz

MicroFlow Sensor

PHYSICAL

Dimensions	See Chapter 4 Velocity Sensors for dimensions
Sensor Body Materials	Valox 357
Mounting connection	Via 1" BSP or NPT back mounted thread, 45° angled bracket (optional).
Mounting Angle	45° optimum and mounted at the center line of the channel with clear uninterrupted flow.
Sensor Body weight	Nominal 0.7kg (1.54lbs.)
Sensor Cable Extensions	5-core screened
Maximum separation	Up to 500m (1,640 ft.)

ENVIRONMENTAL

Enclosure protection	IP68
Max and Min Temperature	-20 °C to +70 °C (-4°F to +158°F)

APPROVALS

CE and Radar Approval	Refer to MicroFlow manual for EU Certificate of Conformity
ATEX Approvals	CML 16ATEX2331X, IECEx CML 16.105X II 2 G Ex mb IIC T4 GbII 2 D EX mb IIIC T135oC Db Tamb -20°C to +60°C

PERFORMANCE

Velocity Range	0.2 – 6 m/s
Accuracy	Greater of +/- 0.5% or 0.03 m/s
Optimum Installation	Install at an angle of 45°. Further information can be found in Chapter 4 Velocity Sensors – Locating the MicroFlow.
Maximum channel width per sensor	1.5m
Radar	K-Band (ISM)
Transmit power	<15dBm
Beam Width	20° Inclusive

OUTPUTS

Communication	RS485 and Modbus RTU-Integrates with compatible Pulsar controllers.
----------------------	---

PROGRAMMING

PC Programming	Via RS485 Modbus
Programmed data integrity	Via non-volatile memory
PC Software	MicroFlow PC – Compatible with Win 7, Win 8 and Win 10

SUPPLY

Operating Voltage	10-28V DC
Power Consumption	0.36W (15mA at 28V DC)

Pulsar Measurement operates a policy of constant development and improvement and reserve the right to amend technical details, as necessary.

EU Certificate of Conformity**EU DECLARATION OF CONFORMITY****P U L S A R *FlowCert, FlowCert Lite & Flow Star***

This declaration of conformity is issued under the sole responsibility of the manufacturer

Relevant directive(s)	2014/30/EU - EMC directive and its amending directives. 2014/35/EU - Low Voltage directive and its amending directives. 2011/65/EU - RoHS directive and its amending directives.
Manufacturer's name	Pulsar Process Measurement Ltd.
Manufacturer's address	Cardinal Building, Enigma Commercial Centre, Sandy's Road, Malvern, Worcestershire, WR14 1JJ, UK.
Apparatus	Pulsar FlowCert, FlowCert Lite & Flow Star with dB series transducer / Duet.
Standards applied	EN 61010-1:2010+A1:2019 Safety requirements for electrical equipment for measurement, control, and laboratory use. EN 61326-1:2013 EMC, equipment class industrial.

I declare that the apparatus named above has been tested and complies with the relevant sections of the above referenced standards & directives.

Signed for and on behalf of:

A handwritten signature in black ink, appearing to read "Tim Brown".

Date: 7th April 2021.

Rev. 6.2.

Name & function: Tim Brown, electronics engineer.

Pulsar Process Measurement Ltd.

CHAPTER 2 FLOWCERT INSTALLATION

Unpacking

Important Information

All shipping cartons should be opened carefully. When using a box cutter, do not plunge the blade deeply into the box, as it could potentially cut or scratch equipment components. Carefully remove equipment from each carton, checking it against the packing list before discarding any packing material. If there is any shortage or obvious shipping damage to the equipment, report it immediately to Pulsar Measurement.

Power Supply Requirements

FlowCERT can operate from AC supply or from a DC battery. The AC is 115V +5%/-10% 50/60Hz or 230V +5%/-10% 50/60Hz, depending on the position of the selector switch. The DC is 22-28V. In all cases the FlowCERT will typically consume 6W of power, with a maximum of 10W. If FlowCERT has both an AC and DC supply available then the AC supply source will be automatically sensed and used, should the AC supply be removed for any reason then the DC supply will take over.

FlowCERT should be mounted by drilling three holes suitable for size 8 screws (length to suit your application) and fixing the top screw in place. Hang the unit on this and fix the two remaining screws by removing the terminals access cover to access the pre-drilled holes.

Location

When choosing a location to mount the enclosure, bear in mind the following:

- Ensure that the FlowCERT is installed in a "Safe", non-hazardous, area.
- For a clear view of the LCD display it is recommended that it is mounted at eye level.
- The mounting surface is vibration-free.
- The ambient temperature is between -20°C and 50°C.
- There should be no high voltage cables or inverters close by.

The FlowCERT must be mounted in a non-hazardous (safe) area, and the transducer fitted in the hazardous area. There are 6 cable gland knockouts on the base of the FlowCERT (5 x 20mm (0.79"), 1 x 16mm (0.63")) and 4 on the rear (4 x 18mm dia (0.73")). Select which ones you wish to take out, and remove them by using a circular cutter, such as a tank cutter. Take care not to damage the circuit board inside whilst undertaking this. Do not use a hammer, as this may cause damage to the enclosure.

It is recommended that you use suitable cable glands to ensure that the ingress rating is maintained.

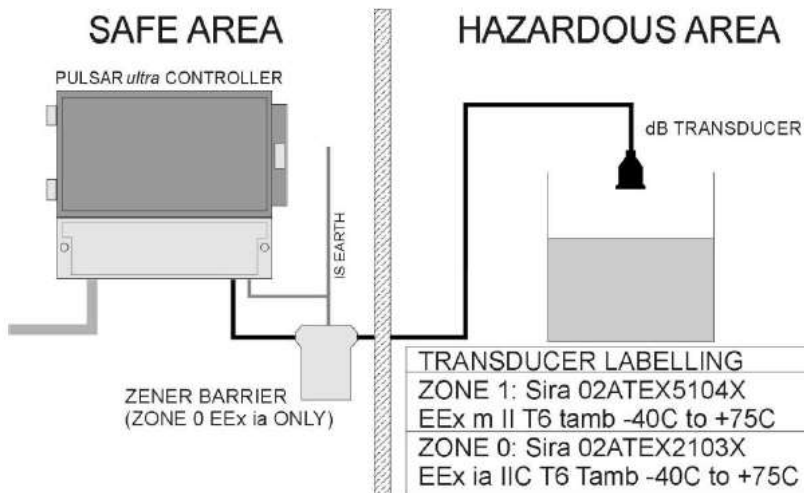

FM APPROVED TRANSDUCERS
Class I, Div. 1, Group A, B, C & D
Class II, Div. 1, Group E, F & G

All electronic products are susceptible to electrostatic shock, so follow proper grounding procedures during installation.

Dimensions

The echo screen displays the echo data. Below is an annotated example of a typical secondary settlement tank sludge interface.

Wall Mount

The dimensions of the wall fixing holes are as shown below:

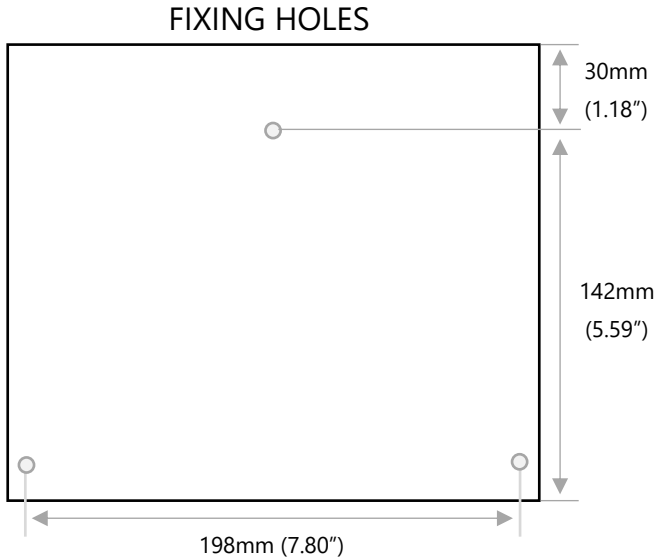

The FlowCERT should be mounted by drilling three holes suitable for size 8 screws (length to suit the application) and fixing the screw in place. Hang the unit on this and fix the two remaining screws by removing the terminal access cover to access the pre-drilled holes.

The full dimensions of the enclosure are as shown below:

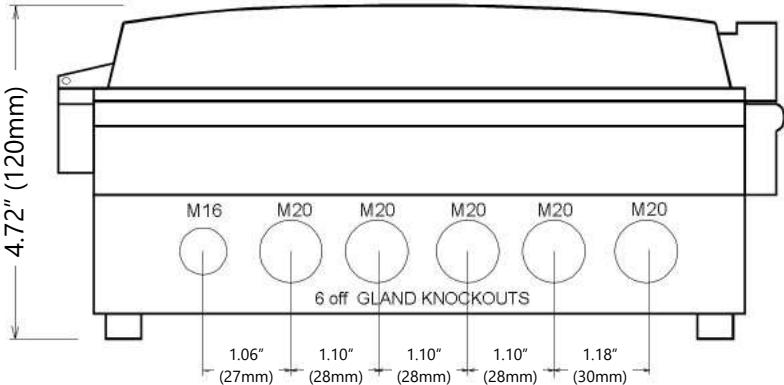
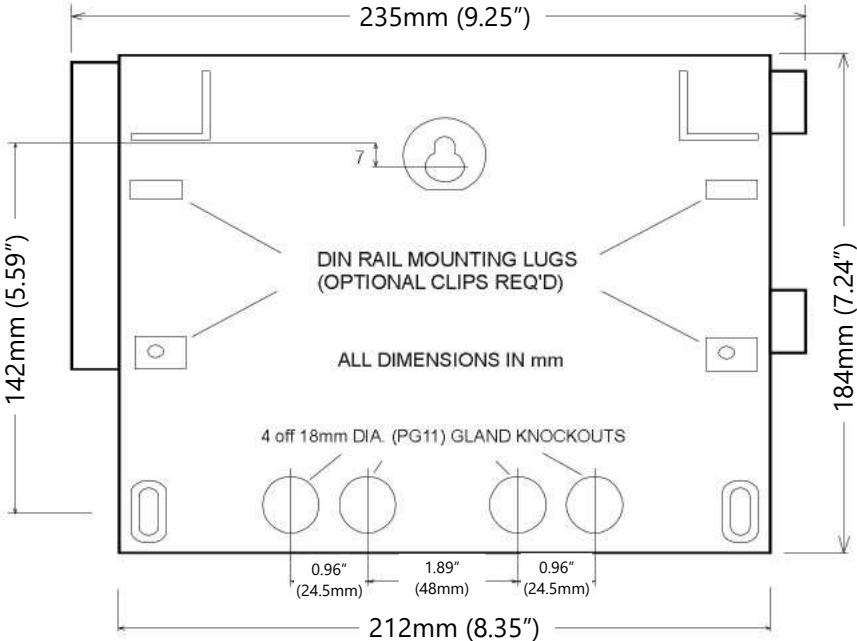

Cable Entry

There are 6 cable gland knockouts on the base of the FlowCERT (5 x 20mm (0.79"), 1 x 16mm (0.63")) and 4 on the rear (4 x 18mm dia (0.73")). Select which ones you wish to take out, and remove them by using a circular cutter, such as a tank cutter. Take care not to damage the circuit board inside whilst undertaking this. Do not use a hammer, as this may cause damage to the enclosure. It is recommended that you use suitable cable glands to ensure that the ingress rating is maintained.

Terminal connection details

There is a wiring diagram inside the terminal access cover, and is shown below:

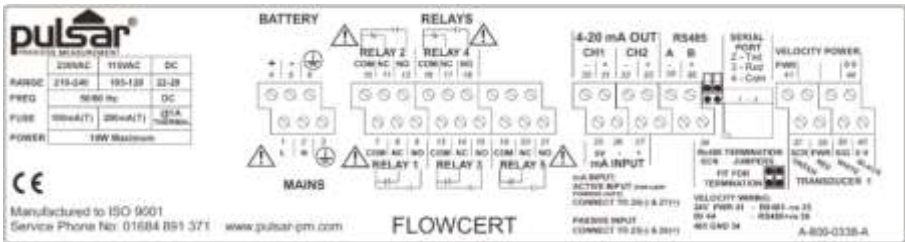

Terminal connections

Power

The FlowCERT can operate from mains AC and automatically from DC or battery backup in the event of power failure or can be operated permanently from DC or batteries.

Transducer

The transducer should be installed, and connected, in accordance with the installation instructions contained in the Transducer User Guide. The entire range of standard dB/DBR transducers is certified for use in hazardous areas and different models are available for use in Zone 1 or Zone 0. DBR16 is also available for use up to Zone 0. Wire the transducer to the FlowCERT transducer terminals as follows:

Transducer 1

TERMINAL CONNECTION DETAILS

Unit Type	Green: Screen	Red: Power	White: Signal	3
Wall Mount	37	38	39	40

When using 2-core screened extension cable, the Black and Green wires of the transducer should be connected to the screen of the extension cable which in turn should be connected to the appropriate 0 volts' terminal of the FlowCERT.

ATEX

For **Zone 1** applications a transducer certified to **Sira 02ATEX5104X** is used, and must be supplied via a 4000A breaking fuse, which is fitted as standard to the FlowCERT.

For **Zone 0** a transducer certified to **Sira 02ATEX2103X** is used, which must be connected to the FlowCERT controller via an external Zener barrier.

FM

For **EEx m (Zone 1)** applications a transducer certified to **FM Class I Div 1 Group A, B, C & D, ClassII Div 1 Group E, F & G, Class III** is used, and must be supplied via a 1500A breaking fuse, which is fitted as standard to the FlowCERT level controller. Restrictions do not use in the presence of these groups of Chemicals, Aliphatic Hydrocarbons, Ketones or Esters.

For **EEx ia (I.S.)** a transducer certified to **FM Class I Div 1 Group A, B, C & D, ClassII Div 1 Group E, F & G** is used, which must be connected to the FlowCERT via an external Zener barrier. See transducer label for certification details.

Relay Outputs

The five relays can be programmed for a variety of alarms, pump control, or other process functions. The relay contacts are all rated at 5A at 240V AC. All connections should be such that the short circuit capacity of the circuits to which they are connected, is limited by fuses rated so that they do not exceed the relay rating.

Current Output

There are two mA outputs which are fully assignable, both outputs are isolated (floating) mA outputs (to 150 V), of 4 - 20mA or 0 - 20mA, and the load should not exceed 500 Ω .

Current Input

This feature facilitates the use of suitable devices to provide an input for level or velocity. The current input will accept both 'active' and 'passive' devices which provide an input of 4 - 20mA or 0 -20mA.

Velocity Input

This feature allows direct connection of a MicroFlow or Speedy velocity sensor, via RS485 communications, to provide the FlowCERT with an input which is proportional to the velocity of flow, to enable calculation of flow using the Area/Velocity formula. For full details and installation instructions of the Speedy and MicroFlow velocity sensor please refer to [Chapter 4 Velocity Sensor](#). In cases where the RS485 is used for communications (MODBUS or PROFIBUS), and therefore not available as an input for the velocity sensor, then the velocity sensor can be connected to the Current Input via an optional Velocity Interface device. For full details and installation instructions of the Velocity Interface, please refer to the relevant manual.

RS232 Interface

If required you can connect to the serial interface, to operate your FlowCERT remotely.

Voltage Selector and Fuse Location

The voltage selector switch, and mains fuse is located inside the terminal compartment. This is left of the mains terminals, as illustrated below:

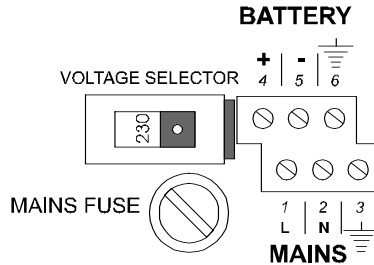

Important Information

Before applying AC power (mains), make sure you have correctly selected the voltage selector switch, as detailed in the preceding pages.

Please note that all units are supplied set to 230 volts AC for safety reasons, and a 100mA fuse fitted as standard.

Never operate the FlowCERT with terminal access exposed.

An external switch or circuit breaker should be installed near to the FlowCERT to allow the supply to be removed during installation and maintenance. In addition, the relay contacts should also have a means of isolating them from the FlowCERT.

Interconnecting cables must be adequately insulated in accordance with local regulations. Strip back 30 mm of the outer insulation of the cable. Strip 5 mm of insulation from the end of each conductor. Twist all exposed strands of the conductor together. Insert the stripped conductor into the terminal block as far as it will go and tighten the terminal block screw. Ensure that all strands are firmly clamped in the terminal block and that there is no excess bare conductor showing, and no stray strands.

DON'T FORGET



Make sure you move the voltage selector switch to the correct position for your power supply

Important Information

If the equipment is installed or used in a manner not specified in this manual, then the protection provided by the equipment may be impaired.

Preparation for Operation

Before switching on, check the following:

- ✓ FlowCERT is mounted correctly and is in a 'safe' area.
- ✓ The power supply is correctly installed.
- ✓ The voltage selector switch is in the correct position.
- ✓ The relays are connected correctly.

Maintenance

There are no user serviceable parts inside FlowCERT, except the mains fuse. If you experience any problems with the unit, then please contact Pulsar Process Measurement for advice.

To clean the equipment, wipe with a damp cloth. Do not use any solvents on the enclosure.

Important Information

The unique DATEM software comes into operation as soon as power is applied and is designed to monitor a **moving level** or **target** with the **transducer** in a **fixed position**.

If, after any period of use, it should become necessary to move the transducer, for any reason, from its original operating position, switch off the FlowCERT, before proceeding, in order to prevent any undesirable updates to the DATEM trace. If after moving the transducer the reading is not as expected, please refer to Chapter 8 Troubleshooting.

CHAPTER 3 DUET TRANSDUCER

DUET Transducer

With the DUET, Pulsar Measurement has taken ultrasonic level measurement accuracy to a new level. With the advent of DUET, the effect of temperature has been removed. DUET produces synchronous pulses from transducers a known distance apart. The returning echoes from the transducers are measured, and the fixed distance between the two is used to dynamically calibrate the measurement to remove the temperature effect. For the first time, genuine "millimetre accuracy" is available in the real world, in a real application.

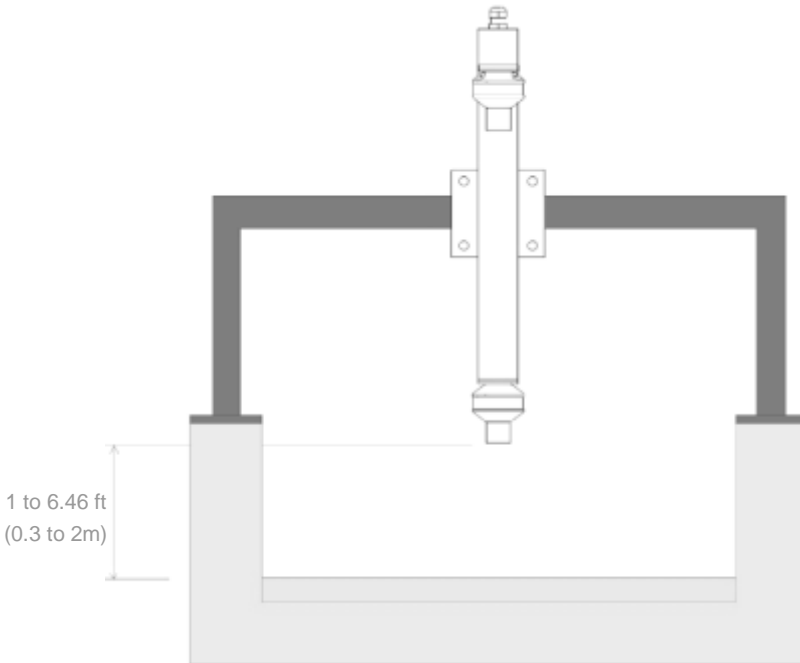

- For optimum performance, the DUET should be installed a minimum of 300mm (12") from the side wall and as close as is reasonably possible, but, no closer than 300mm (12"), from the liquid surface, when the channel is full (maximum head).

- **The DUET should be installed such that the bottom transducer is at least 300mm (12") above the maximum head.**
- The DUET can measure up to 2m (6.56 ft) from the DUET's lower transducer face.
- For MCERT the maximum accuracy will be achieved when the distance from the DUET's lower transducers face to the target is within 1.5m (4.9 ft).
- Ensure the DUET is installed upright and level, perpendicular to the target surface and is fixed securely.
- The 'U' bolts can be fixed horizontally or vertically in the fixing plate dependent on the beam it is being attached to.

Dimensions

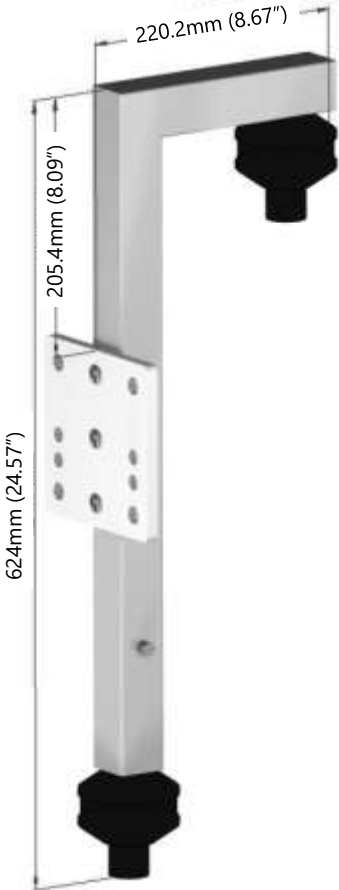

Mounting Plate

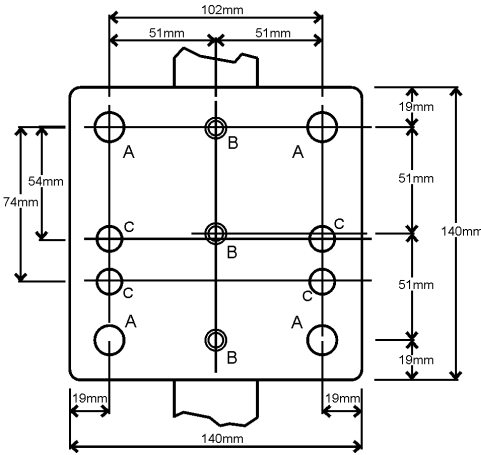

- HOLES**
- A - 14mm DIA.
 - B - COUNTERSUNK TO SUIT M8 SCREWS
 - C - 12mm DIA.

THICKNESS 10mm

Fixings

The DUET is supplied with two large 'U' bolt clamps and two smaller 'U' bolt clamps (dimensions below) with all the necessary washers and nuts included.

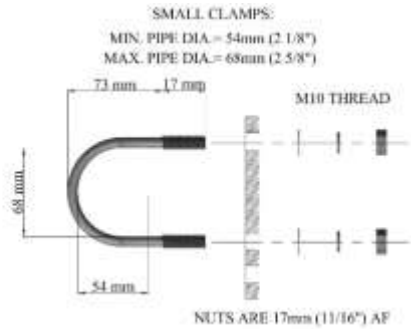
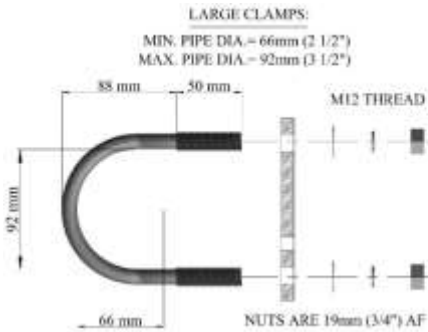

Fitting Options

Using the fixings supplied, the DUET can be mounted using any of the following three methods.

1. Horizontal bar with large clamps



2. Vertical bar with large clamps



3. Horizontal bar with small clamps



Important Information

When installing the DUET sensor, take care to ensure that there are no obstacles protruding into the path of the higher transducer around the area of the mounting bracket.

CHAPTER 4 VELOCITY SENSORS

For channels without primary elements the MicroFlow and Speedy Velocity Sensors can be used with the FlowCERT to perform the calculation of Flow (Q) = Velocity x Area for a wide variety of channel shapes and pipes.

Functional Description

Speedy

The Speedy is designed to measure the velocity in all open channels and pipes of any shape or size. The flow level (depth/height) is measured by the ultrasonic transducer connected to the FlowCERT whilst the flow velocity is measured by the velocity sensor, which utilises ultrasonic Doppler technology. The flow velocity measurement is transferred to the FlowCERT using the proprietary communications protocol through the RS 485 terminals.

Speedy – FlowCERT Configuration

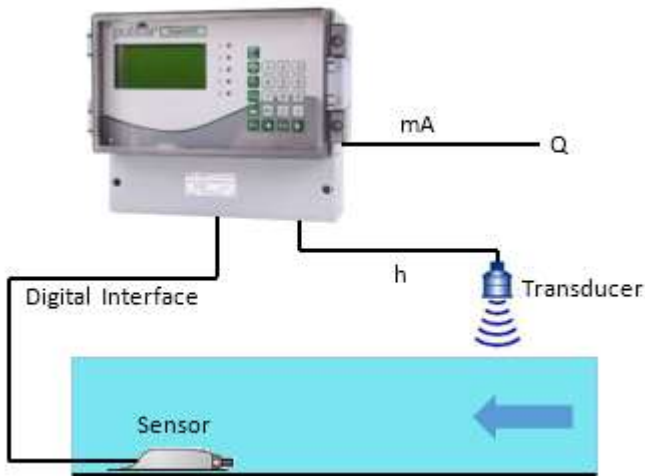

MicroFlow

The MicroFlow is a non-contacting velocity sensor. The sensor provides reliable flow velocity measurements using short pulses of micro-waves, which are transmitted by an enclosed antenna. The reflected signal is captured by the on-board microprocessor via the antenna and analysed and transferred to the FlowCERT to determine the velocity.

The MicroFlow automatically matches to the protocol and Baud rate of the controller. When it is connected to the FlowCERT and powered up, after approx. 20 seconds the sensor will adjust to the Baud rate of the FlowCERT.

MicroFlow – FlowCERT Configuration

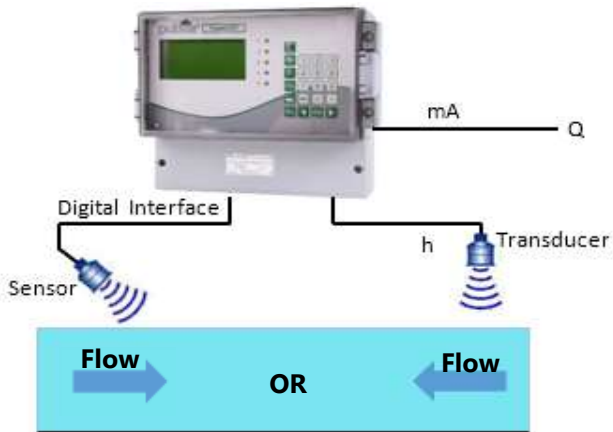

Limitations of use

- The MicroFlow must be routinely inspected to avoid the build-up of dust layers when installed into Zone 21 & 22.
- Electrostatic Hazard: The MicroFlow must only be wiped with a damp or antistatic cloth.
- Only leaded little fuses (0242 series) of 100mA should be used with the Exmb approved MicroFlow.
- Outer enclosure is made from Valox 357U, consider the performance of this material with respect to chemicals that may be present in hazardous areas.
- The equipment should not be used if there are any cracks/damage to any part of the enclosure.

Technical Data

Speedy Dimensions

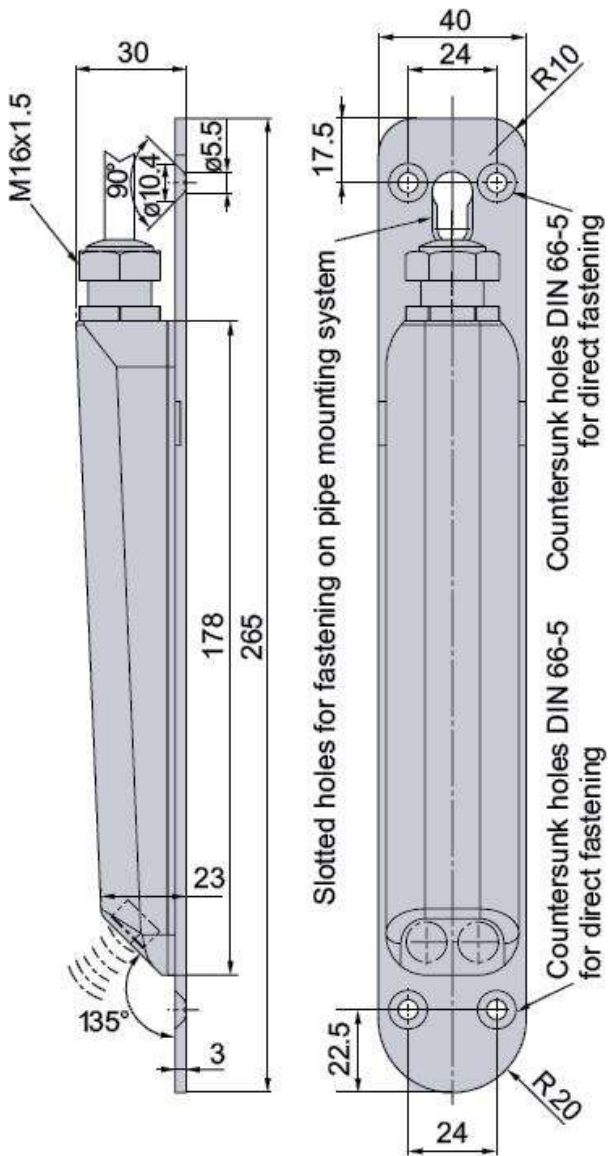

All dimensions in the above drawing are in metric (millimeters)

MicroFlow Dimensions

The dimensions of the sensor body are shown below:

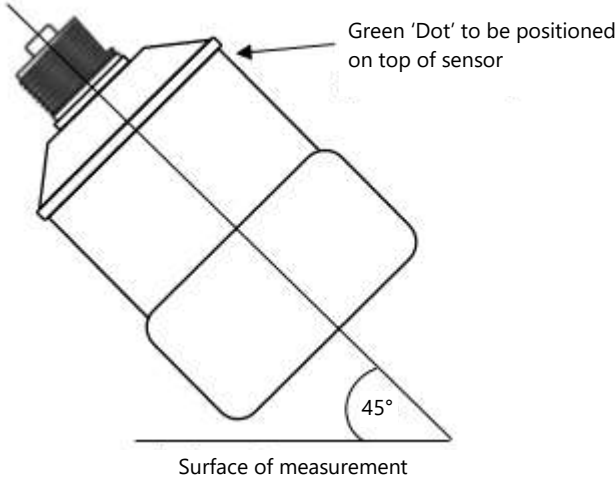
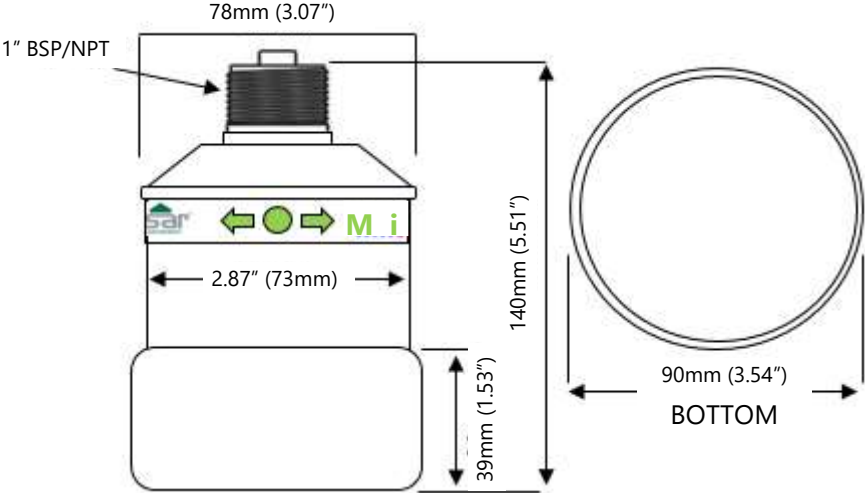

 To obtain the most accurate results, ensure the device is mounted at a 45° angle to the surface being measured.

Mounting

For optimum results it is highly recommended to use the MicroFlow angled bracket, which is available from your Pulsar distributor, which will ensure that the MicroFlow can be correctly installed. The bracket can be used if the MicroFlow sensor is to be mounted on its own in a specific location or along with a Pulsar dB transducer. Please see the diagram below Angled Mounting Bracket, for dimensions of this bracket, please note that the drawing is not to scale.

‘**Mounting sensor to a bracket**’ illustrates how you would install the sensor to one of Pulsar’s angled brackets.

The MicroFlow angled bracket should be mounted by marking and drilling the holes suitable for fixing your screws/bolts (length to suit your application) and then fixing the bracket in place.

Angled Mounting Bracket

Part number: dBA0008MF

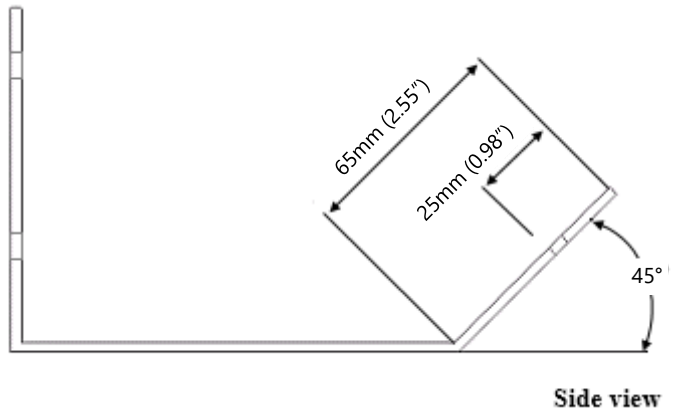

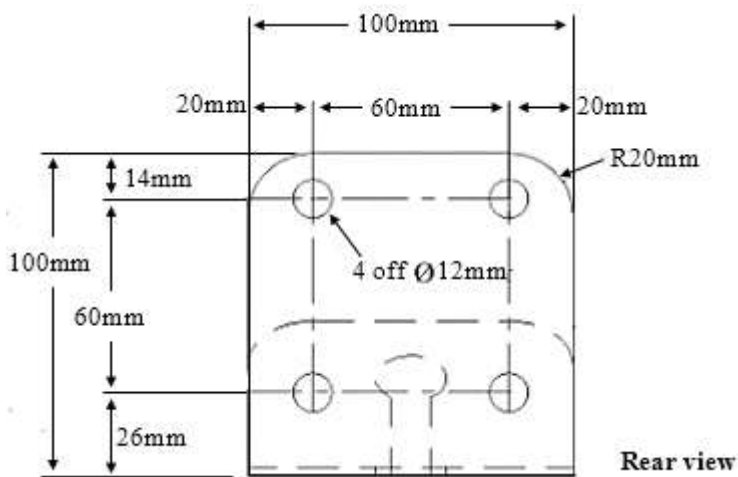
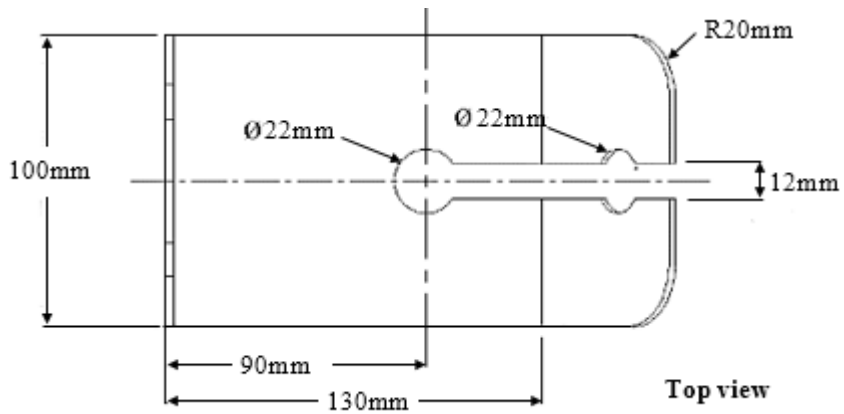

Important Information

Using a spirit level, ensure that the mounting bracket is level **before** attaching the sensor to it.

Mounting sensor to a bracket

Mounting the sensor to the 45° angled bracket is done via an adapter and M20 nut, as shown in the diagram below:

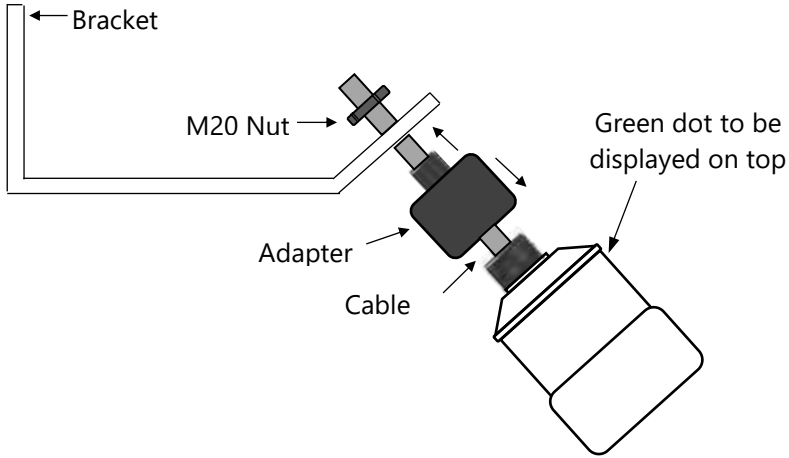

For correct installation, we recommend that the adapter is threaded on the cable, and carefully screwed onto the MicroFlow before fitting to the bracket. This will reduce the risk of any 'twisting' in the cable.

Ensure that the sensor is tightened, and the dot is in the correct position.

Important Information

When fixing the sensor to the adapter, ensure that care is taken when pulling the sensor cable through. And once attached to the adapter, and the M20 nut is tightened, the green dot should be central to the movement of flow as shown in Fig.1.

Fig.1

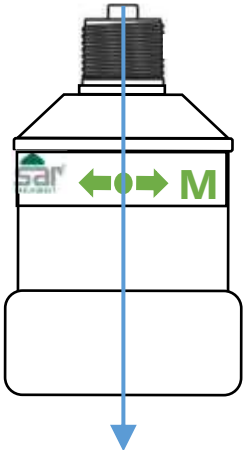

Central to the movement of flow in channel.

Care should be taken not to overtighten the sensor when everything is connected, as seen in the diagram below, as this could cause damage to the housing.

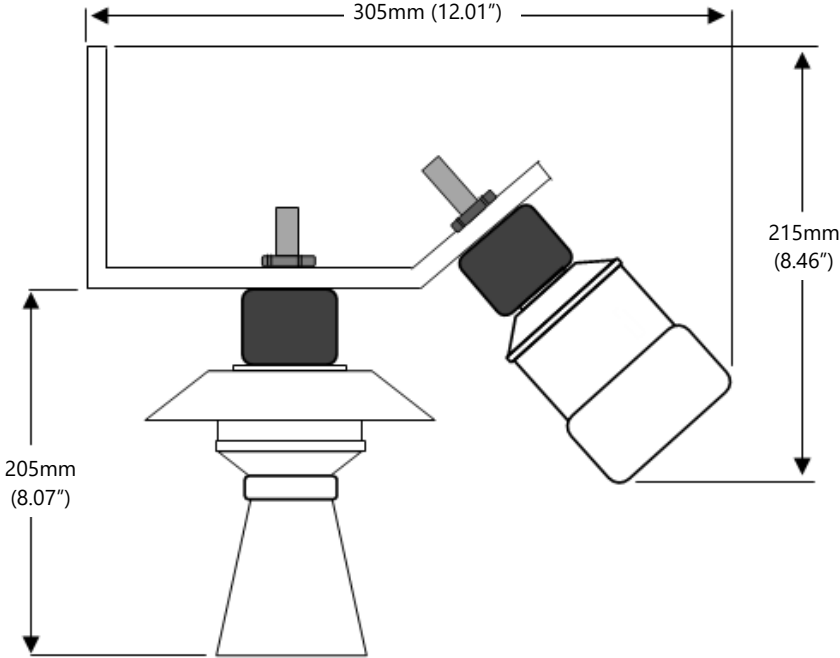

Velocity sensor warranty and liability

Pulsar Measurement guarantee for a period of 12 months for a Speedy sensor and 24 months for a MicroFlow. From the date of delivery, that it will either exchange or repair any part of this product returned to Pulsar Measurement. If it is found to be defective in material or workmanship, subject to the defect not being due to unfair wear and tear, misuse, modification or alteration, accident, misapplication, or negligence.

Velocity sensor wiring details

The Pulsar FlowCERT is interfaced to a Velocity sensor via a digital communications interface through the RS485 terminals. The sensor also takes its power from the FlowCERT unit. The terminal strip for the wall mount FlowCERT is as detailed below. There is also a wiring diagram inside the terminal access cover.

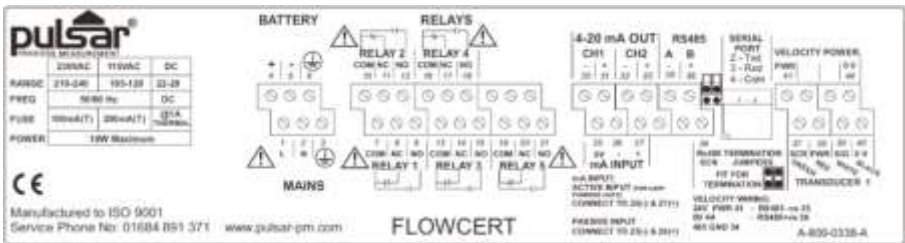

Details on connecting the Speedy sensor to the FlowCERT are as follows:
 Bootlace Ferrules

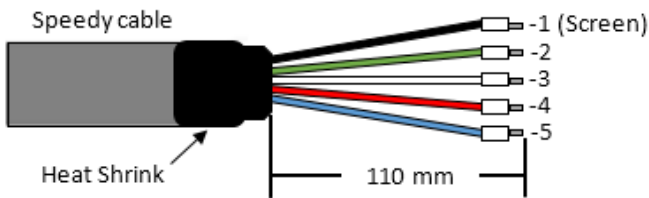

CABLE COLOUR	FLOWCERT TERMINALS	DESCRIPTION
Black	34	RS485 Common
Green	35	RS485 – (A)
White	36	RS485 + (B)
Red	41	24 Volt DC Supply
Blue	44	0 Volt DC Supply (GND)

Details on connecting the MicroFlow sensor to the FlowCERT are as follows:

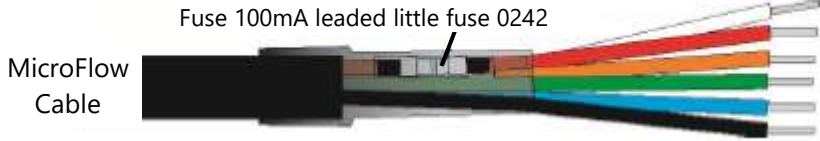

CABLE COLOUR	FLOWCERT TERMINALS	DESCRIPTION
Blue	34	RS485 Common
White	35	RS485 - (A)
Orange	36	RS485 + (B)
Red	41	24 Volt DC Supply
Black	44	0 Volt DC Supply (GND)

The Green cable (cable screen) should be connected to Earth such as terminal 44 (0V).

Installation of Speedy Sensor

Limitation of Performance

Correct installation and the positioning of the Speedy sensor is essential for maintaining measurement accuracy and the reliability of a Speedy velocity unit, and there are a number of factors which will limit the performance of the Speedy Velocity Sensor.

1. Temperature – the speedy velocity sensor should only be operated in the temperature range stated in the Product Specification section of this Chapter, operation outside of this temperature range will have a significant effect on the accuracy of velocity measurement.
2. Measurement Medium – the speedy velocity sensor uses ultrasonic Doppler technology and therefore relies on the transmitted signal being reflected back to the sensor from particles (solids) contained in the media, it is therefore not suitable for the measurement of velocity in media that do not contain particles e.g. clean water. Speedy should only be used in medium that is compatible with the materials used in the construction of the speedy, resistance and compatibility lists for the materials used are available from Pulsar on request. Highly abrasive medium may lead to mechanical wear of the sensor and in the case of high velocities or large particle size this may result in permanent damage to the sensor.
3. Hydraulic disturbance – correct installation, of the Speedy sensor, in the vicinity of bends, profile changes, gates/slides and any form of hydraulic ramp/jump are essential to ensure accuracy of measurement. Changes to direction of flow (streaming or reverse/surge flows) must also be avoided at the point of measurement.

Positioning of the Speedy Sensor

The required mounting distances between any hydraulic disturbance and the installation point are as follows:

Change of Profile

$h < 2.5\%$ of Diameter, $L > \text{min. } 3 \times \text{Diameter}$

$h > 2.5\%$ of Diameter, $L = \text{distance to where standing wave does not exist anymore.}$

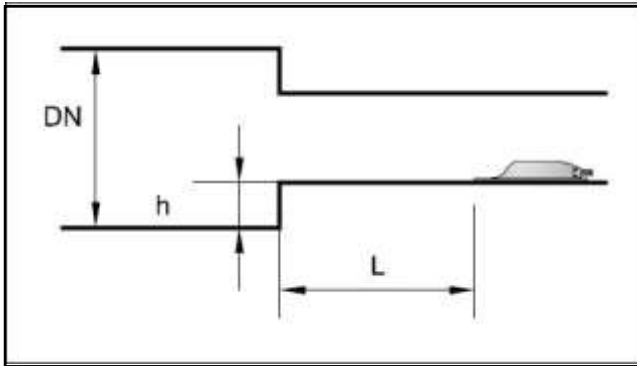

Curves and Bends

for $v < 1\text{m/s}$ (3fps): $a < 15^\circ$ $L > \text{min. } 3 \times \text{Diameter}$

$a < 45^\circ$ $L > \text{min. } 10 \times \text{Diameter}$

$a < 90^\circ$ $L > \text{min. } 20 \times \text{DN}$,

for $v > 1\text{m/s}$ (3fps): $a > 15^\circ$ $L = \text{distance until the surface of the water reaches laminar flow}$

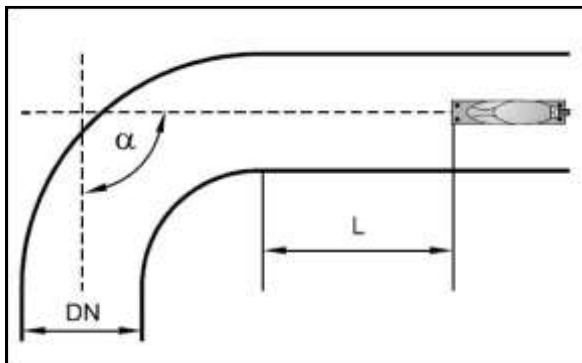

Distance from valves and slide gates

Sensors on front of slide gates

$L = 3 \times \text{Diameters}$

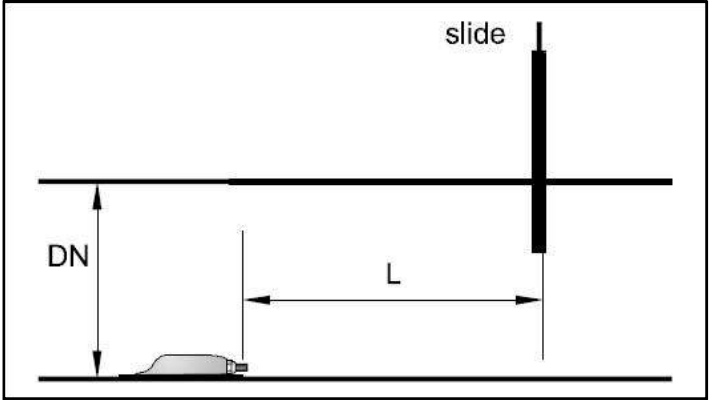

Sensors on front of slide gates

$L \geq \text{distance until a steady flow rises plus } 2 \times \text{Diameter}$

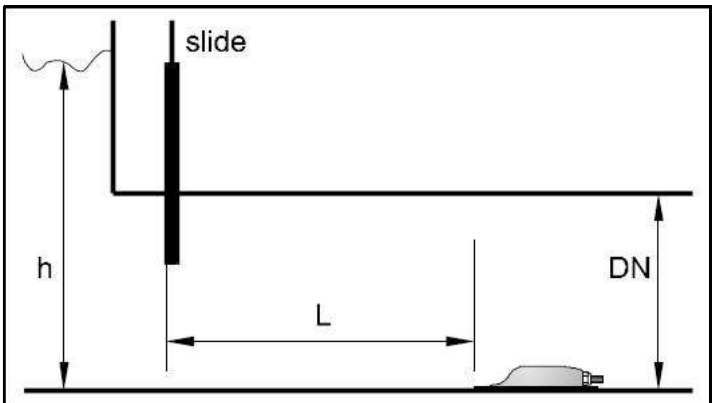

Steps or obstruction

$h < 2.5\%$ of Diameter $L \geq \min 3 \times \text{Diameter}$

$h > 2.5\%$ of Diameter $L = \text{distance until a steady flow rises plus } 2 \times \text{Diameter}$

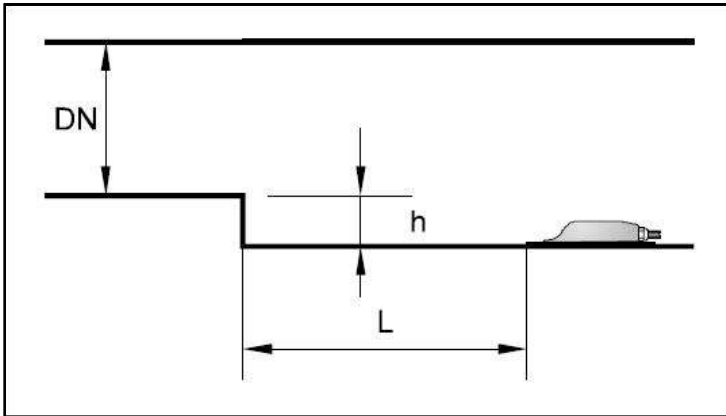

Flumes and Channels

For installations in a flume or channel please note the following:

Installation must be parallel to flow direction

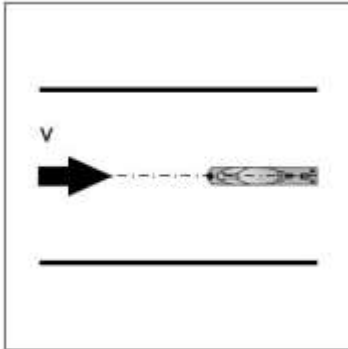

Installation: normally central

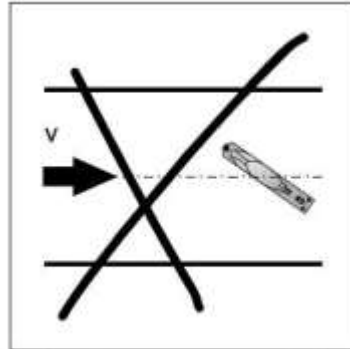

Fault: wrong measurement values

Installation must be against the flow direction

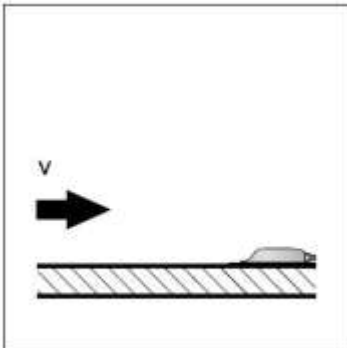

correct installation

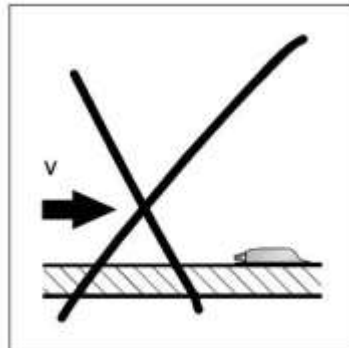

Fault: negative flow direction

Installation must be parallel to the floor

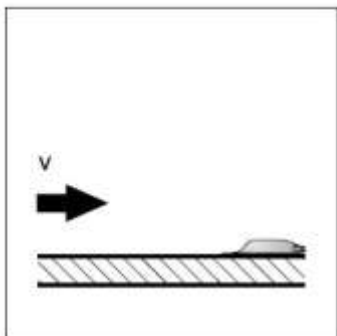

correct installation

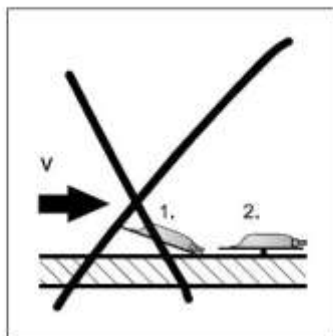

Fault: risk of error (1) and sensor break (2)

Cable installation

$r \geq 5 \text{ cm}$ $L \geq 10 \text{ cm}$

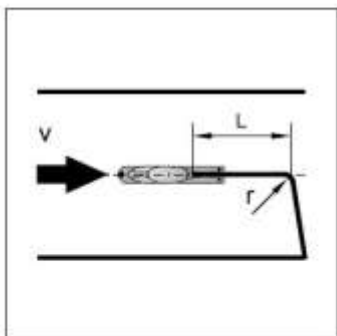

correct cable layout

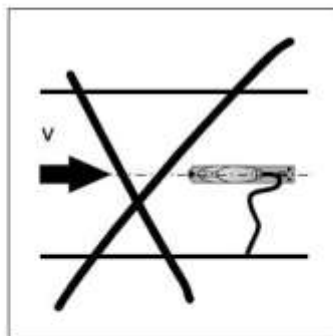

Fault: build-up and cable damage

Positioning of the MicroFlow sensor

For optimum accuracy install the *MicroFlow* where the flow is not turbulent. An ideal location for the sensor is in the centre of a long straight channel. Vertical drops, baffles, curves, or junctions can cause the velocity profile to be distorted.

To obtain optimum results in velocity readings, the MicroFlow sensor requires surface ripples to be present to provide a reliable measurement. If there are not any surface ripples within the sensors field of view under ant flow conditions, then an alternative measurement point should be found, or ripples created.

Locating the MicroFlow

- If the width of the channel exceeds 1.5m. Multiple MicroFlow sensors are required to be used in conjunction with the Ultimate Controller.
- When a level measurement transducer is used and mounted on the same bracket as the MicroFlow. Consider, the 'blanking' distance of the transducer when mounting the bracket for the application.
- Ensure that there is an unobstructed path between the sensor and the surface of the moving liquid being measured.
- Position the sensor at a height of 250mm above maximum liquid level or up to two times the channel width from the minimum liquid level, whichever is greater. As shown in the diagram below:

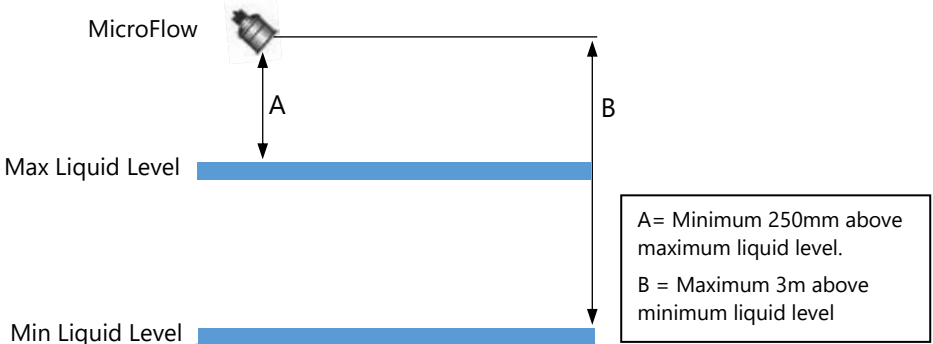

Important Information

If the maximum water height exceeds 2x width of the channel OR if the maximum water height in the channel is <50% of the width of the channel. Please contact Pulsar Technical Support for assistance.

Hazardous Area Installation

Not all MicroFlow models are ATEX certified, check label for approval details. The 'X' in the certifications number indicates that certain special conditions apply.

This version must be supplied from apparatus that provides protection from prospective short circuits up to 1500A. The fuse is fitted in the safe area end of the cable.

Important Information

Below is an example of the wrap around label that is found on an ATEX approved MicroFlow. If this information does not appear on the label of your MicroFlow sensor it is not ATEX approved for hazardous area.

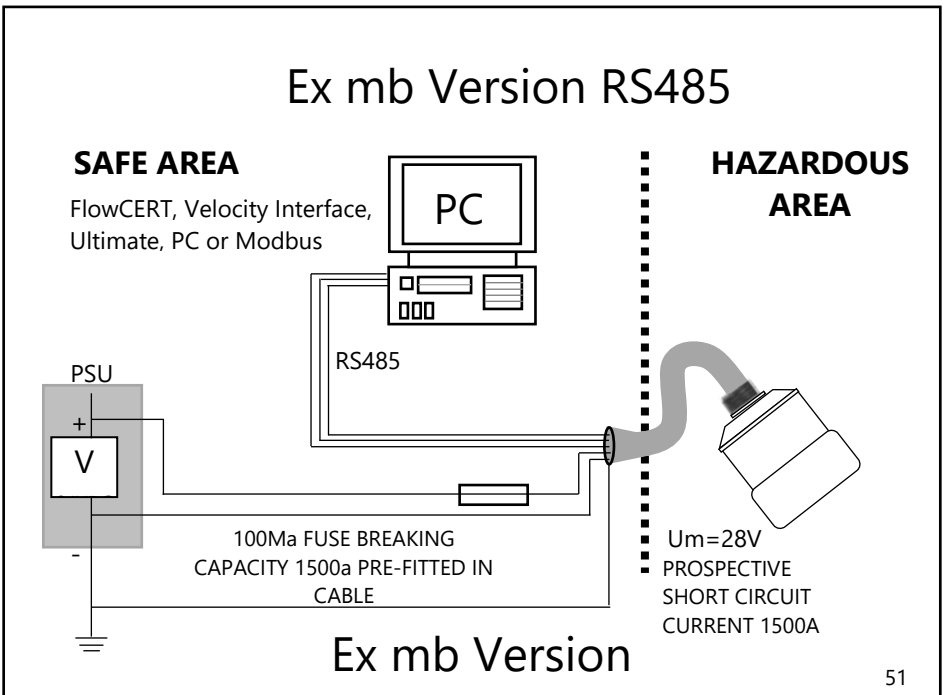

In the instance where there are vertical drops, baffles, curves, or junctions. The sensor should then be positioned on a straight part of the channel, at a minimum distance that is at least five times the width of the channel before a bend, to obtain optimal velocity readings.

Examples of positioning the sensor are shown in diagrams 1 - 4 below

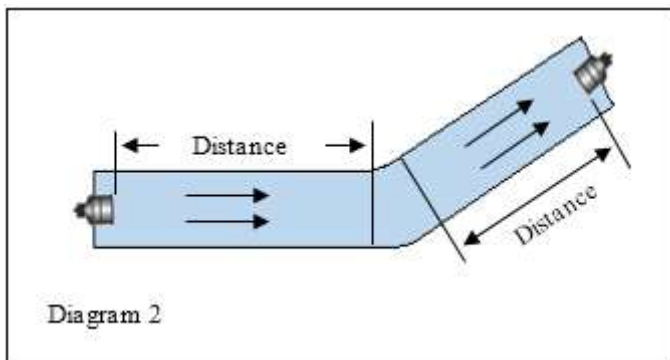
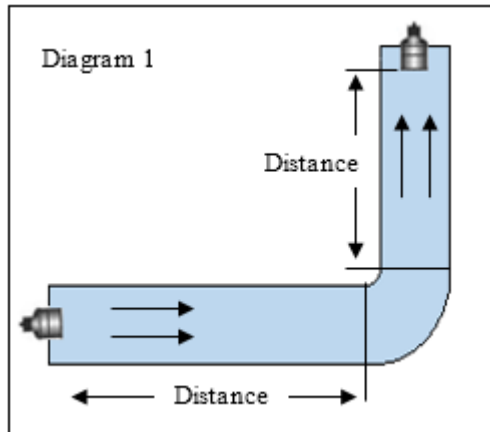

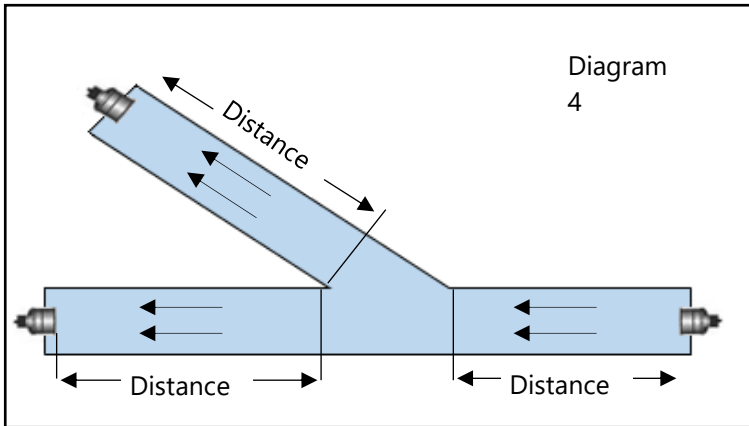
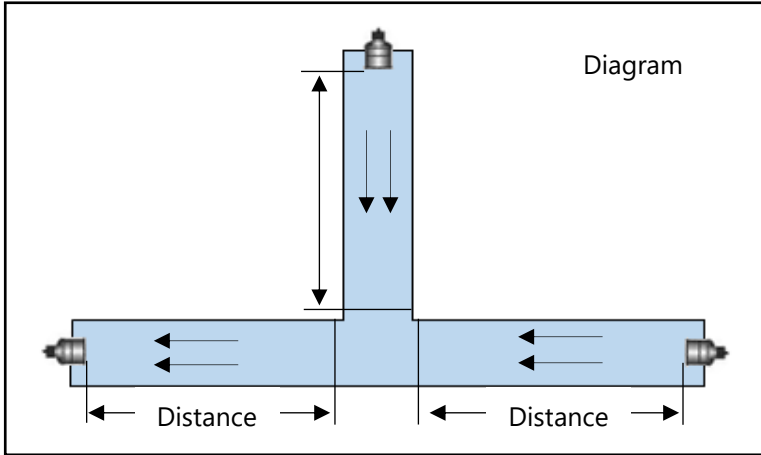

Installing the sensor

- The sensor housing is designed to accept a 1" BSP/NPT female threaded coupler for pipe or conduit.
- Ensure that the sensor is positioned at a 45° angle to the surface of the measured application, as this will achieve the best results. An example of this is shown in the diagram below:

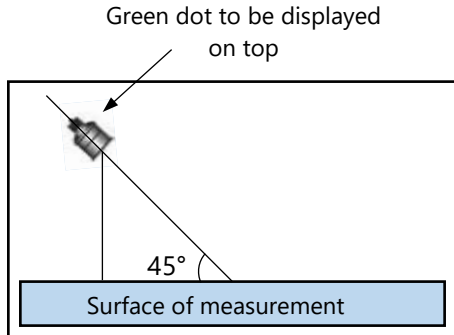

- When using one of the angled mounting brackets, secure the bracket using the correct size screws/bolts/U-bolts (12mm diameter thread).
- Tighten the sensor into the bend, and then screw the thread adapter onto the bracket using the nut supplied.

CAUTION: extreme over-tightening may crack or cause damage to the unit or bracket.

- Position the sensor so the green 'dot' that is shown on the label between the two green arrows is on the top of the device and is central to the movement of flow in the channel.
- If desired, the sensor cable may be extended up to a maximum of 100m. Install the sensor cables in grounded metal conduit. Do not run in cable trays or duct banks with variable frequency drives or other high voltage sources.
- When connecting multiple MicroFlow sensors for use with the Ultimate controller. Ensure that all wiring in any junction /connector box is correct.

- The sensor can be positioned to obtain readings following the direction of the flow. Or it can be positioned to measure the oncoming flow as seen below:

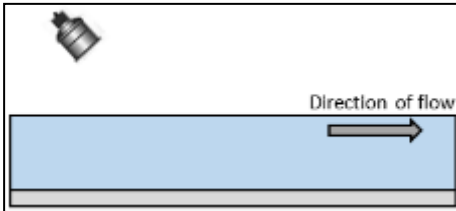

Microflow obtaining readings following the direction of the flow.

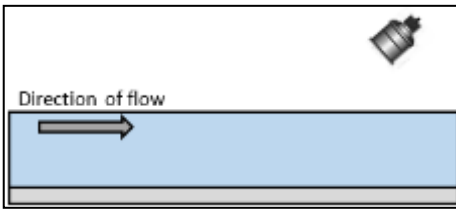

Microflow obtaining readings from the oncoming direction of the flow.

Preparation for Operation

Before switching on, ensure that the following is checked:

- ✓ Microflow is mounted correctly and is secure.
- ✓ All wiring is correct to a Pulsar controller.
- ✓ The power supply is correctly installed.

General Maintenance

There are no user serviceable parts inside Microflow. If you experience any problems with the unit, then please contact Pulsar Process Measurement for advice.

To clean the equipment, wipe with a damp cloth. Do not use any solvents on the enclosure.

Operation and Parameters

Quick Start Guide

- Install and connect your FlowCERT and your ultrasonic transducer as described in [Chapter 2 FlowCERT Installation](#).
- Install and connect your Velocity sensor to the FlowCERT as described earlier in this chapter.
- Power up the unit and enter program mode by keying in '1997' and pressing Enter to begin to set-up an application for Area Velocity.
- Refer to [Chapter 6 Quick Set-up Guide](#) on how to select the FlowCERT for 'Area Velocity' calculation or alternatively go directly to **P700** and select **4 = Area Velocity**.
- Once you have selected Area Velocity calculation (P700 = 4), set **P130 'Device Mode'** to **2 = 'Velocity'** ('Speedy' in Ultra firmware 7.4.3 and below) to enable the velocity parameters.
- To change the maximum flow velocity to suit your application, you will need to set **P683 'Maximum flow velocity'** to the desired value (in m/s).
- All other velocity parameters can be left at their default values or can be adjusted to suit the application, i.e. '**P688 Gain**' and '**P684 Damping**' can be altered to the value range outlined in [Chapter 7 Parameter Guide](#).
- If you wish to view the instantaneous flow velocity measurement on the auxiliary display of the FlowCERT then, **P815 Auxiliary Source** should be set to **1 = Velocity**, the auxiliary display will then alternate between displaying the flow units and the current flow velocity, please note that the instantaneous flow velocity cannot be displayed in the auxiliary display when the re-settable totaliser is selected.
- If no further changes are required, return to run mode and after a short time, the flow should be displayed (provided there is suitable minimum head and minimum velocity).

FlowCERT Parameter list for Speedy

By selecting the appropriate flow device type for area/velocity (P700=4), the Velocity menu becomes available and provides the following parameters:

PARAMETER (P) NO.	DESCRIPTION	UNIT
680	Speedy update interval	Seconds
681	Sound velocity in water	Rate
682	Minimum flow velocity	Rate
683	Maximum flow velocity	Rate
684	Damping factor	Seconds
685	Peak width	%
686	Minimum signal quality	%
687	Stability	Seconds
688	Gain	DB
689	Speedy level	MU
690	Automatic gain control	None
691	High level triggered	None
695	Correction factor	None

FlowCERT Parameter list for MicroFlow

PARAMETER (P) NO.	DESCRIPTION	UNIT
680	Speedy update interval	Seconds
682	Minimum flow velocity	Rate
683	Maximum flow velocity	Rate
684	Damping factor	Seconds
687	Stability	Seconds
688	Gain	DB
695	Correction factor	None

For full details on the parameters contained in the above tables, please refer to [Chapter 7 Parameter Guide](#).

Communications and recovery

The FlowCERT unit will communicate with the Velocity sensor at regular intervals as specified by parameter P680 (in seconds).

To enable the sensor to work successfully with the FlowCERT, please ensure that the FlowCERT's power is disconnected when connecting a sensor to it.

On power up, the FlowCERT will initialise and write the current depth as specified by parameters P680 to P689. After the sensor is automatically changed to measurement enabled mode, the FlowCERT unit will read the flow velocity and associated run time variables at regular intervals.

To assist on-site debugging and installation, there are three methods to determine whether communication between a velocity sensor and FlowCERT has been established:

1. The red led on the communications processor board, of the FlowCERT, will flash at P680 interval to indicate the sensor is talking to the communications board.
2. The REMOTE icon on the FlowCERT LCD display is flashing on/off at regular interval to indicate the main processor board, of the FlowCERT is talking to the communications processor board.
3. The COMMUNICATOR icon on the FlowCERT LCD display is flashing on/off at regular interval to indicate the communications processor board is transferring valid flow velocity information to the FlowCERT main processor board. The flashing of this icon indicates a successful installation.

Recovery of Velocity sensor communications is automatically initiated by the FlowCERT unit. If there is no response from the Velocity sensor, the FlowCERT will continually send initialisation information until communication resumes. If the auxiliary (bottom) display shows the "**LostComm**" message, then check that the wiring is correct and the baud rate is correct for your velocity sensor, the MicroFlow will adjust its baud rate to match that of the controller. Baud rate can be viewed and edited in P133 in the "Device Comm" – "RS485" sub-menus, the default baud rate for the "Speedy" sensor is 9600.

Maintenance

General

The extent of the maintenance interval for a speedy device is dependent on the following factors:

- Material wear
- Measurement medium and the channel/pipe hydraulics
- General precautions for running these measurement facilities

Flow Velocity

Sluice slime, grease and films of oil will have little or no effect on velocity measurement. In instances where stronger coatings or a complete embedding of the sensor into sludge, fibrous substances or sand/silt will affect the measurement signal such that a measurement error or a measurement loss could be possible. In such cases, regular maintenance and cleaning of the "Speedy" sensor will be necessary.

Wear and tear from abrasive medium to the Speedy transmit and receiving sensors will lead to a weakening of signal, in extreme cases this may lead to the complete failure of the sensor, and in such instances, the sensor may have to be replaced.

CHAPTER 5 HOW TO USE YOUR FLOWCERT

Operating the Controls

Display

The display provides information on the current mode of operation, and status of the remote communication. Whilst in the Run Mode it will display the current level reading and its units of measure, along with status messages with regards to the Transducer, Echo reception and Fail Safe Mode. Additionally, it can be programmed to provide status messages on alarms, pumps etc. When in the Program mode the display is used to read information on the Menu System, Parameter Number and parameter details and values, which can be entered. During Test Mode, the display is used to monitor the simulated level. A bar graph is also provided which will provide a visual reading of the level, in percentage of span.

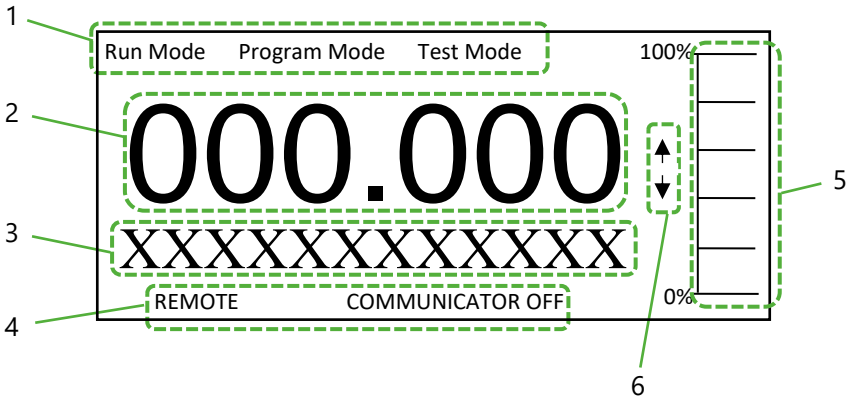

1. Displays the current mode of operation
2. Main 6-digit display:
 - Run Mode;** current measurement displayed, dependent on mode and measurement units chosen, and value of hotkey selected.
 - Program Mode;** displays parameter number and values entered for parameters.
 - Test Mode;** displays simulated level.

3. Auxiliary Display, scrolling twelve-digit display.
Run Mode; displays measurement units, status messages on signal and transducer, details of Hot Key function selected. It can be also programmed to provide notification messages on alarms and pumps etc. For full details please refer to Display Parameters in the relevant parameter listing.
Program Mode; displays menu and sub menu headings, parameter details and options.
4. Communicator status, this displays the status of remote PC connection and velocity sensor operation.
5. Bar graph display, this gives visual indication of measurement in % of span.
6. Level indicators:
Run Mode; indicates in which direction the level is moving.
Program Mode; indicates at which level of the menu system you are at.

There are two main operating modes for your FlowCERT, **Run Mode** and **Program Mode**. There is also a **Test Mode**, used for checking the set-up. All modes are now described.

Run Mode

This mode is used once the FlowCERT has been set up in program mode. It is also the default mode that the unit reverts to when it resumes operation after a power failure.

When FlowCERT is switched on for the first time, it will display, in metres, the distance from the transducer face to the target. All relays by default are switched off.

After programming is complete, any relays that are set will operate when the level reaches the relevant setpoint, and the LED's will change colour (unless specifically switched off).

Program Mode

This mode is used to set up the FlowCERT or change information already set. You must use either the built-in keypad (standard) or, alternatively the unit can be set up with a PC via the RS232 Serial Interface.

Entering a value for each of the parameters that are relevant to your application provides all the programming information.

How to Access Program Mode

To enter program mode on the FlowCERT, you simply enter the passcode, via the keypad, followed by the ENTER key. The **default passcode** is **1997**, so you would press the following:









Important Information

There is a time-out period of 15 minutes when in program mode. After which time the run mode will resumed if you do not press any key.





Hot Keys

There are five hot keys on the keypad, which can be used to quickly access common parameters for viewing only, while in Run Mode. Pressing the hot key once will display the first parameter, then repeated pressing will display the others, then the FlowCERT reverts to Run Mode. In program mode, they have different functions, the functions are shown below.

HOT KEY	RUN MODE	PROGRAM MODE
	When application is Flow, you can view the non-resettable totalizer. View and reset the resettable totalizer.	Not used with the FlowCERT
	Displays echo confidence, echo strength, height above loss limit (HALL), average noise, peak noise and temperature	Not used with FlowCERT
	Not used with FlowCERT	Reset parameter to default setting
	Instantaneous mA output	Not used with FlowCERT
	Dependent on application. Displays distance, level, space, flow or rate of change of level, velocity (if velocity sensor attached)	Toggle relay setpoints between units of measure and % of span.
	Not used with FlowCERT	Takes you to the last parameter edited when you first enter program mode.
	Shows details of function type, firmware revision and serial number	Enter decimal point.

Menu Keys

The menu keys have the following functions:

HOT KEY	FUNCTION
	1) Arrow keys for moving left and right around the menu system. 2) Used in test mode to simulate the level moving up and down.
	
	1) Used to confirm each action (e.g. select a menu option)
	Used to navigate up a level in the menu system, and back to run mode. Used to cancel a value entered in error

Numeric Keys

These keys are used for entering numerical information during programming.

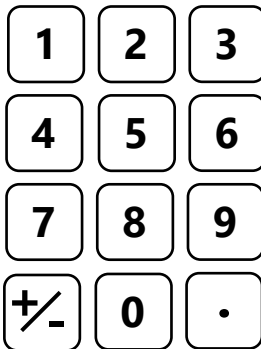

There are two means of editing parameters, directly or using the menu system. Each is now described.

Using the Menu System

The menu system has been designed to make the changing of parameters very simple. There are two levels of menu: **Main Menu** and **Sub Menu**.

On the display, there is a line of text that displays the menu system. Pressing the arrow keys scrolls the display between the top-level menu items, (as the example shown below, starting at Quick Setup).

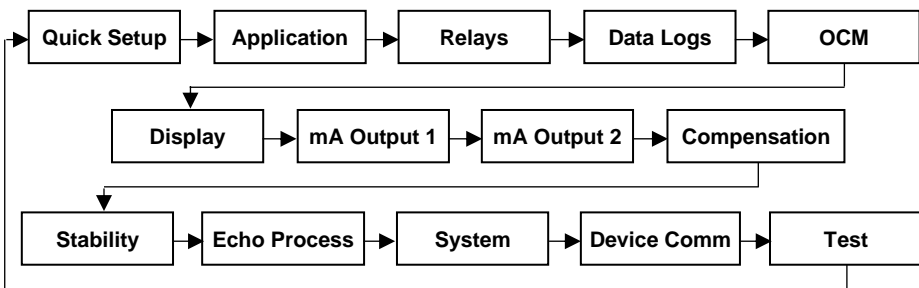

As you press the cursor keys to scroll left and right between these, you can press ENTER at any time, to select the desired menu heading, and take you to the sub-menu.

Each of these options, along with their sub-menus, are described later in this manual. When you move down into the sub-menu, you can scroll round using the arrow keys, press ENTER to go to the required section of parameters.

Once you have reached the relevant section, scroll through the parameters, and enter the necessary information. To enter the information, use the numeric keys and then press ENTER, you will then see the message "**Saved!**" If you press CANCEL, then the change you made will not be saved, and the message "**Unchanged!!**" will be displayed.

When you have finished, press CANCEL to go back to the previous level. When you have reached the top level, then the FlowCERT will ask for confirmation before allowing you to go back into run mode. This is done by pressing ENTER at the display prompt.

Important Information

You can tell which part of the menu system you are in, as the up/down level indicators, (arrows) next to the bar graph will indicate as follows:

- **Top level menu: Down arrow on**, to indicate you can move down.
- **Sub-menu: Up and Down arrows on**, to indicate you can move up to the top level, and down to parameter level.
- **Parameter Level: Up arrow on**, to indicate you can move up to sub-menu level.
- **Parameter Editing: No arrows on**.

Directly Editing Parameters

If you already know the number of the parameter, that you wish to look at or edit, simply type the number in at any time while you are in the menu system. Thus, if you are in either the menu or sub-menu level by pressing a numeric key, you can enter the parameter number directly and jump straight there. You cannot type a parameter number whilst at parameter level, only at one of the two menu levels.

When you are at a parameter, the text line rotates automatically displaying the parameter name, number, the applicable units, and the maximum and minimum figure you can enter. The top line shows the value you are setting.

Once you have accessed a parameter, you can either just look at it, or change it.

Once a parameter has been changed, press 'ENTER' and you will see the message "**Saved!**". If you press 'CANCEL', then the change you made will not be saved, and the message "**Unchanged!!**" will be displayed.



You can jump straight to the last parameter you edited, by pressing '+/-' when you first enter program mode.

Test Mode

Test mode is used to simulate the application and confirm that all parameters and relay setpoints have been entered as expected. During simulation, there is a choice of whether the relays will change state (hard simulation) or not (soft simulation), but the LED's will always change colour as programmed, and the mA output will change in accordance to the chosen mode of operation. If you wish to test the logic of the system that the **relays are connected** to then select **hard simulation**, but if you **don't wish to change the relay state**, then select a **soft simulation**.

There are two simulation modes, automatic and manual. Automatic simulation will move the level up and down between empty level or the pre-determined **Start Level (P983)** and Pump/Control relay switch points, if you wish to change the direction of the level movement e.g. to go beyond relay setpoints, this can be done by using the arrow keys. In manual simulation, using the arrow keys will allow you to move the level up and down as required.

To enter simulation, first go to program mode. Using the menu system, select menu item '**Test**', then sub-menu item '**Simulation**'. Simply change the value of the parameter **P980** to one of the following:

- 1= Manual soft simulation
- 2= Automatic soft simulation
- 3= Manual hard simulation
- 4= Automatic hard simulation

To return to program mode, press 'CANCEL' and test mode will end.

When in manual simulation, by default test mode will move the level by 0.1m steps. Altering the **increment (P981)** will change this value.

In **automatic** mode, the rate at which the level moves up and down is set by the increment (P981 in metres, and the **rate (P982)** in minutes, which can be changed to make the level move up and down faster. E.g. if increment (P981) is set for 0.1m and rate (P982) is set to 1 min then the level will increase or decrease at a rate of 0.1m/min. To make the simulated level move slower, decrease the value in increment (P981) or increase the value in rate (P982). To make the simulated level move faster, increase the value in increment (P981) or decrease the value in rate (P982).

Using the Serial Interface

The RS232 serial interface is used to communicate between the FlowCERT and a PC using the optional Ultra PC and other associated Pulsar software packages, to obtain information such as data logging and view echo traces upload, download and save parameter files. In addition, it can also be used to control or obtain information using a standard PC or other computer base equipment. To do so, the settings for control are as follows: **baud rate 19,200, 8 data bits, no parity, 1 stop bit.**

The device should be connected as shown in [Chapter 2 FlowCERT Installation](#).

To use the device remotely, you need to **log on** to start, and **log off** when finished. When **logged on**, FlowCERT will show '**Remote ON**' on the display, and "**Communicator OFF**" when **logged off**.

All commands should be followed by a carriage return.

When logged on, the unit will respond either OK (or a value) if the command is accepted, or NO if it is not.

To log on, send the command

/ACCESS:pppp where pppp is the passcode (P922).

To log off, send the command

/ACCESS:OFF

To read a parameter value, send the command

/Pxxx where xxx is the parameter you wish to read, and the FlowCERT will respond with the parameter value.

To set a parameter, send the command

/Pxxx:yy where xxx is the parameter number, and yy is the value you wish to set it to.

Other commands you can use are:

/LEVEL (shows current level)

/SPACE (shows current space)

/HEAD (shows current OCM head)

/FLOW (shows current OCM flow)

/TEMPERATURE (shows current temperature)

/CURRENTOUT1 (show the mA output 1 value)

/CURRENTOUT2 (show the mA output 2 value)

/CURRENTIN (show the mA input value)

/BACKUP1 (take backup of parameters to area 1)

/BACKUP2 (take backup of parameters to area 2)

/RESTORE1 (restore parameters from area 1)

/RESTORE2 (restore parameters from area 2)

Please consult Pulsar Measurement or contact your local Pulsar representative for further details and a full list of available commands.

Parameter Defaults

Factory Defaults

When first installing the **FlowCERT**, or subsequently moving or using the unit on a new application, before proceeding to program the unit for its intended application it is recommended that you ensure that all parameters are at their default values by completing a **Factory Default P930**, as described in the relevant unit type **parameter guide**.

When you first switch the FlowCERT on, it will be reading the **distance** from the face of the transducer to the surface. It will be indicating in **inches**, as shown on the display. All relays are set OFF.

The **date (P931)** and **time (P932)** in the FlowCERT were set at the factory, but may need checking, and amending if, for example the application is in a time zone other than GMT, see relevant parameter listing for full details.



In some applications, it is easier to empty the vessel, take a reading from the FlowCERT for distance and then setup the empty level to this figure.

Once you are satisfied with the installation, and FlowCERT is reading what you would expect in terms of distance from the face of the transducer to the material level, then you can proceed with programming, for the intended application. It is sensible to program all of the required parameters at the same time. The system will be then set-up.

Note: *The span is automatically calculated from the empty level, so the empty level should be entered first.*

CHAPTER 6 QUICK SETUP GUIDE

This quick set-up guide shows you how to get up and running within a few minutes of installing your FlowCERT.

Enter Program Mode

First you need to go from run mode into program mode. Assuming the passcode is the default 1997, then you should enter the following on the keypad:

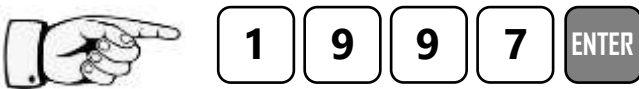

Choose Quick Setup

Now you need to go into the quick setup. You will see on the menu the words 'Quick Setup', which is the first item on the menu system. Try pressing the two arrow keys to see some more menu options, but return to Quick Setup, and press

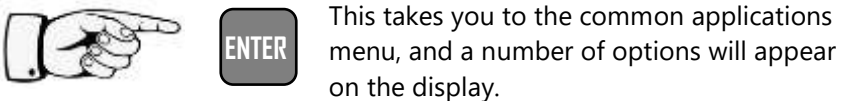
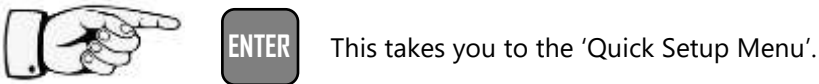

Important Notice

If you have already setup a common application, then there will be a number shown other than 0, and you will see messages showing what the current setup is. If you want to reset this and start again, press 0 (which will reset all the quick setup parameters), otherwise pressing ENTER will allow you to edit the parameters that have been set.

Choose Your Application

There are six categories of **Primary Measuring Device**, which are all described in this chapter. They are **Exponential, BS3860 flumes, BS3860 weirs, Area/Velocity, Special and Universal**.

Calculations for flow can be performed using absolute or ratiometric calculations. The answer will be the same, the choice of calculation method being limited to the amount of information available, with regards to the primary measuring device.

For ratiometric calculation it is normally sufficient to know the maximum flow at maximum head for the device in question. All types of primary measuring devices can be set up with a choice of alarms.

If you want to set-up a basic **Exponential device**, as described in the following **example 1**, then choose 1. You then need to select the PMD for your application from the following available options: **Suppressed Rectangular Weir, Cipolletti (trapezoidal) weir, Venturi flume, Parshall flume, Leopold Lagco flume, V notch weir, Contracted Rectangular weir** or **other**, for any other type of exponential device.

To set-up an application for a **BS3680 flume**, as described in the following **example 2**, then choose 2. You then need to select the PMD for your application from the following available options: **Rectangular flume with or without hump, U-throated flume with or without hump**.

To set-up an application for a **BS3680 weir**, as described in the following **example 3**, then choose 3. You then need to select the PMD device for your application from the following available options: **Rectangular weir, V notch full 90° (90degrees), V notch half 90° (53 degree 8 minutes), V notch quarter 90° (28 degree 4 minutes)** or a **Broad Crested weir**.

To set-up an application for **Area Velocity**, then choose 4. You then need to select the PMD for your application from the following available options: **U-channel** (circular bottom with straight sides), **Rectangular channel, Trapezoidal channel, Round pipe** or a **Fixed pipe**.

To set-up an application for a device contained in **Special**, choose 5. You then need to select the PMD for your application from the following available options: **Palmer Bowlus flume, H-flume** or a **V notch**, other than BS3680.

For devices which do not match any of the above devices the application can be setup using a **Universal flow calculation**, to select this option choose 6. You then need to select the PMD for your application from the following available options: **Linear flow** or **Curved flow**.

For devices that are using an Area x velocity sensor and the minimum velocity can get lower than programmed, a universal breakpoint system can be programmed to take over when the flow/velocity falls seen by the sensor is low. To select this option choose 7.

Once you have chosen your application you will be asked a series of questions which are answered by choosing the appropriate option as detailed in the flow chart below. Once all of the questions have been answered you will be prompted to provide further information, as detailed in the tables below, in order to complete the programming of the unit.

Quick Setup

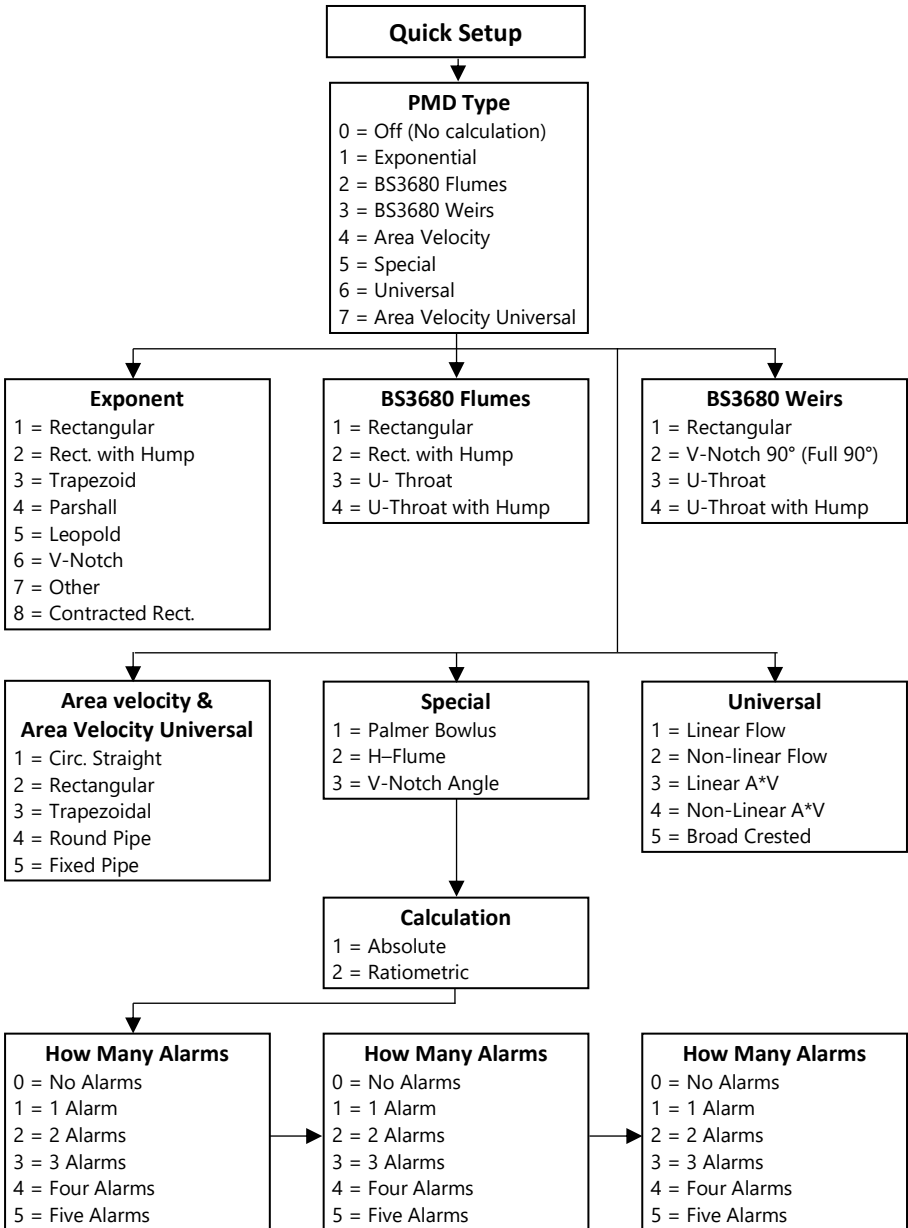

Wait....

PARAMETER	DEFAULT	DESCRIPTION
P101 Transducer	9 = DUET	Select transducer to be used.
P706 Volume Units	1 = Litres	Units of flow on display and used for calculations. 1=litres 2=Cubic metres 3=Cubic feet 4=UK gallons 5=US gallons 6=Mil. USG
P707 Time Units	1 = Second	Units of time that flow units will be displayed and calculated in. 1=units/sec 2=units/min 3=units/hour 4=units/day
P104 Measurement Units	1 = Metres	Units used to enter dimensions and displayed where appropriate. 1=Metres 2=Centimetres 3=Millimetres 4=Feet 5=Inches
P105 Empty Level	1.50m	Distance from the face of the transducer (lower transducer on DUET) or end of the horn (dB Mach3) or lens face of a mmWAVE to the material at the bottom of the measuring element.
P703 Minimum Head	0.00m	Distance from empty point (P105) to zero flow.
P704 Maximum Head	1.20m	Distance from zero flow to max flow. It should be noted that any change from P704 updates P106 Span and vice versa
P824 Totaliser Enable	1 = On	Enables the flow totaliser, P820, options are 0=Off, 1=On . Note this totaliser can be viewed during run via the totaliser "Hot Key" It can be reset but only via P820, whilst in "program mode".
P816 Totaliser (R)	0 = No	Enables the totaliser to be displayed in the auxiliary display whilst in "run mode". Note this totaliser is "resettable", whilst in "run mode", via the totaliser hot key.

PARAMETER	DEFAULT	DESCRIPTION	
P823 Totaliser Multiplier	4 = *1	1 = /1000 3 = /10 5 = *10 7 = *1000 9 = *100,000	2 = /100 4 = *1 6 = *100 8 = *10,000 10 = *1,000,000

The remaining parameters required to finalise the setup of your application will follow on immediately from the above. These parameters relate to details required to carry out the calculation for flow and will be dependent on the PMD chosen and the method of calculation chosen, please enter values for the parameters concerned as requested.

PARAMETER	DEFAULT	DESCRIPTION	
P705 Max Flow	0.00	If Ratiometric is selected: When requested enter the known maximum flowrate, in units of volume (P706) and Time (P707) which occurs at maximum head (P704). If Absolute is selected: The maximum flowrate will be shown here as calculated by the unit.	
P710 Dimension A	0	When requested enter, in measurement units, P104, the required dimension.	
P711 Dimension B	0	When requested enter, in measurement units, P104, the required dimension.	
P712 Dimension C	0	When requested enter, in measurement units, P104, the required dimension.	
P717 Exponent	Dependent on chosen PMD	Where available the FlowCERT will automatically enter the default exponent value for the PMD chosen, but this can be changed if required. When P700=7 (Other), enter the exponent value as defined by the manufacturer of the PMD.	
P718 K Factor		Enter the 'K' factor for the PMD, obtained from the manufacture's specification	
P719 Throat Width		Enter the Throat Width for the Parshall Flume, obtained from the manufacturer's 'specification	

For More Options Hit Enter....







PARAMETER	DEFAULT	DESCRIPTION
P213 / P214 Relay 1 ON/OFF setpoints	depends on application	Set required Alarm Setpoints.
P223 / P224 Relay 2 ON/OFF setpoints	depends on application	Set required Alarm Setpoints.
P233 / P234 Relay 3 ON/OFF setpoints	depends on application	Set required Alarm Setpoints.
P243 / P244 Relay 4 ON/OFF setpoints	depends on application	Set required Alarm Setpoints.
P253 / P254 Relay 5 ON/OFF setpoints	depends on application	Set required Alarm Setpoints.
P708 Flow Decimal	2	Set the number of decimal points required in the flow rate display
P709 Flow Cut Off	5.00%	Enter as a percentage of maximum flow, the minimum flow rate to be added to the totaliser.
P830 mA Out Range	2= 4 to 20 mA	What the mA output uses for the range. 0= Off, 1= 0 to 20 mA, 2= 4 to 20 mA, 3= 20 to 0 mA, 4= 20 to 4 mA.
P870 Fill Damping	10m/min	Rate of maximum fill rate (set above the actual fill rate of the vessel).
P871 Empty Damping	10m/min	Rate of maximum empty rate (set above the actual empty rate of the vessel).

Default values used for determining the **relay setpoints**, when setting **Alarm** relays, via the **Quick Setup** menu are entered as a % of span and are as follows:

PARAMETER	ALARM ID	ON SETPOINT	OFF SETPOINT
Alarm	Hi Hi	90%	85%
Alarm	High	85%	80%
Alarm	Low	10%	15%
Alarm	Lo Lo	5%	10%

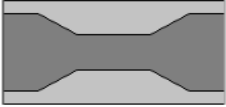
Exponential Devices (P700 = 1)

If the primary measuring device is a simple exponential device, then an exponent value is required. The FlowCERT will automatically enter the exponent value for the device chosen as detailed in the table below.

EXPONENT TYPE	PMD SHAPE EXAMPLE	EXPONENT (P717)
Suppressed Rectangular Weir (Without end contractions)		1.50, automatically set by the unit.
Cipolletti (Trapezoidal) Weir		1.50, automatically set by the unit.
Venturi Flume		1.50, automatically set by the unit.
Parshall Flume		Automatically calculated according to the throat size.
Leopold Lagco Flume		1.55
V-Notch Weir		2.50
Other	As per manufacturer	Value to be set as required.
Contracted Rectangular Weir (With end contractions)		1.50

Point of Measurement

The transducer must be above the **maximum head P704** by at least the near **blanking distance P107**.

For **Suppressed/Contracted Rectangular, Trapezoidal and V-notch**, weirs, the head is measured **upstream** at a minimum distance of **3 times maximum head** from the weir plate to ensure the surface of the liquid is not affected by turbulence or drawdown. (See DRWG. 1)

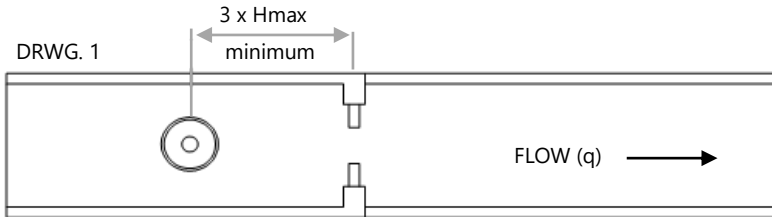

In the case of a **Venturi** flume the point of measurement should be **150 mm upstream** from the beginning of the **converging section** and for a **Parshall** flume **2/3 the length of the converging section** upstream of the **throat** section. (See DRWG 2 and 3).

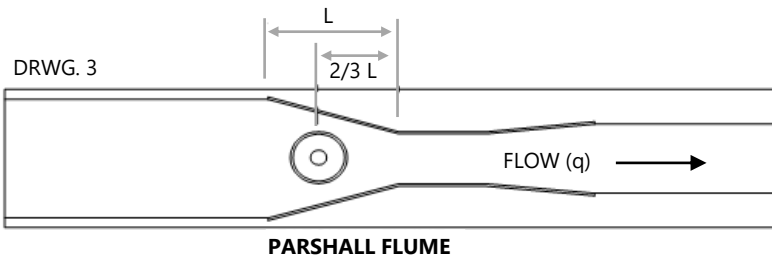
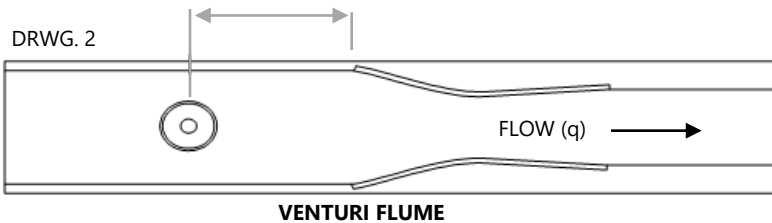

For a **Leopold Lagco** flume the head is measured at a point **upstream** of the beginning of the converging section as detailed in the table below. (See DRWG 4).

FLUME SIZE		POINT OF MEASUREMENT	
mm	inches	mm	inches
100 - 305	4 – 12	25	1.0
380	15	32	1.3
455	18	38	1.5
530	21	44	1.8
610	24	51	2.1
760	30	64	2.5
915	36	76	3.0
1065	42	89	3.5
1220	48	102	4.0
1370	54	114	4.5
1520	60	127	5.0
1675	66	140	5.5
1830	72	152	6.0

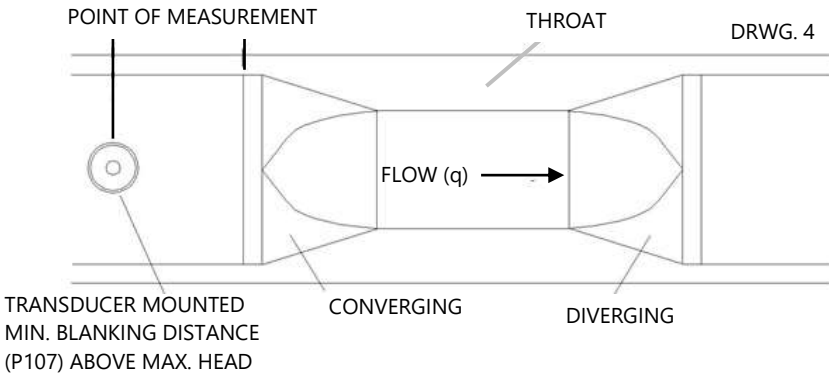

When any **Other** device is chosen please consult the manufacturer of the device for details of where the point of measurement should be located but ensure that it is chosen such that the surface of the liquid is not effected by turbulence or drawdown.

Calculations

Absolute

If the flow calculation is to be absolute P702 = 1 the flow will be calculated using the formula (s) as follows:

EXPONENT TYPE	FORMULA	EXPONENT	K FACTOR
Suppressed Rectangular Weir (Without end contractions)	$Q = KLh^*$ Where: Q=Flow K=K Factor L=Crest length of weir h=head *=exponent	1.50 Automatically selected by the FlowCERT	Automatically calculated, dependent on measurement, flow and time units chosen.
Cipolletti (Trapezoidal Weir)	$Q = KLh^*$ Where: Q=Flow K=K Factor L=Crest length of weir h=head *=exponent	1.50 Automatically selected by the FlowCERT	Automatically calculated, dependent on measurement, flow and time units chosen
Venturi Flume	$Q = Kh^*$ Where: Q=Flow K=K Factor h=head *=exponent	1.50 Automatically selected by the FlowCERT	Enter value of K Factor (P718) as required
Parshall Flume	$Q = Kh^*$ Where: Q=Flow K=K Factor h=head *=exponent	Automatically calculated, dependent on throat size (P719)	Automatically calculated, dependent on measurement, flow and time units chosen

EXPONENT TYPE	FORMULA	EXPONENT	K FACTOR
Leopold Lagco Flume	$Q = KD^{0.0953}h^x$ Where: Q =Flow K=K factor D=pipe diameter h=head *=exponent	1.55 Automatically selected by the FlowCERT	Automatically calculated, dependent on measurement, flow and time units chosen
V-Notch Weir	$Q = Kh^x$ Where: Q =Flow K=K factor h=head *=exponent	2.50 Automatically selected by the FlowCERT	Automatically calculated, dependent on measurement flow and time units chosen.
Other	$Q = Kh^x$	Enter value as required	Enter value as required
Contracted Rectangular Weir (With end contractions)	$Q = K(L - 0.2 * h)h^x$	1.50 Automatically selected by the FlowCERT	Automatically calculated, dependent on measurement flow and time units chosen.

Ratiometric

If the flow calculation is to be **ratiometric P702 = 2** the flow will be calculated using the formula: $q = q_{cal} (h/h_{cal})^x$

Where:

q = flowrate

q_{cal} = **flowrate at maximum head (705)**

h = head

h_{cal} = **maximum head (P704)**

x = exponent (determined as in absolute calculation above)

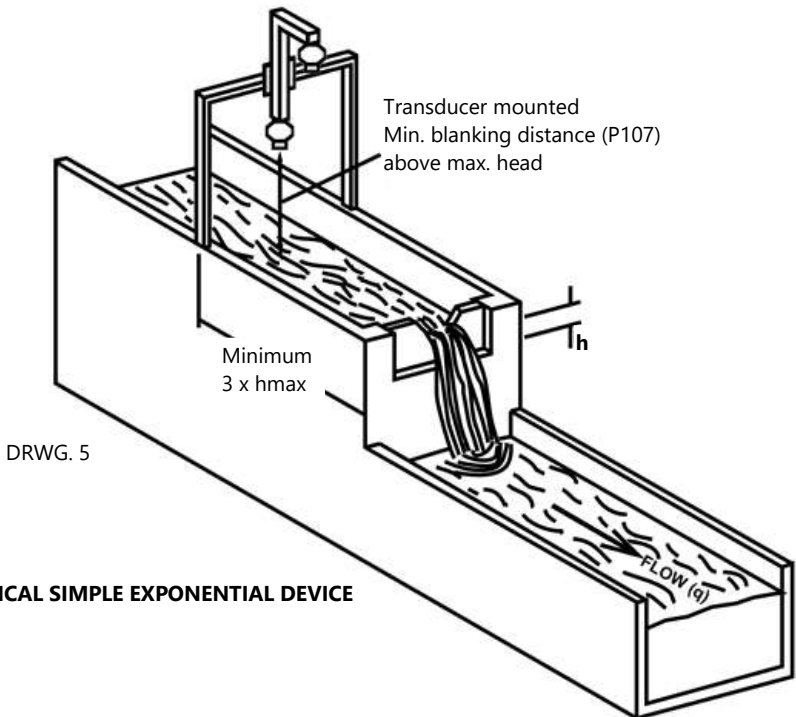
Example 1 V-Notch Weir**TYPICAL SIMPLE EXPONENTIAL DEVICE**

In this example it is required to calculate the flow through a Simple Exponential Device, which on this occasion is a V-Notch Weir. The K factor for the weir is unknown so ratiometric calculation will be used, there is no requirement for alarms and the flow rate is to be displayed in litres/second. The totaliser is to record the flow in cubic metres but is not to be displayed during RUN.

The distance from the face of the lower transducer (DUET) to **zero** flow (P105) is 1 metre and **max head (P704)** is 0.4 metres, **maximum flow(P705)** is known to be 96.5 litres/second.

To program the FlowCERT for **Example 1 V-Notch Weir** by using the **Quick Setup** menu proceed as follows. If required access the **Program Mode** , key in the passcode 1997 and press **ENTER**. Using the 'right' arrow key, go to the **Quick Setup** menu press **ENTER** and as prompted, by the questions, select the relevant option and press **ENTER**.

QUESTION	OPTION
PMD Type	1 = Exponent
Exponent	6 = V-Notch
Calculation	2 = Ratiometric
No. of alarms	0 = No alarms
Transducer	9 = DUET
Volume units	1 = Litres
Time units	1 = Per second
Measurement units	1 = Metres
Empty Level	1.00m
Minimum head	0.00m
Maximum head	0.40m
Totaliser enabled	1 = On
Totaliser (R)	1 = Yes
Totaliser multiplier	4 = *1
Maximum flow	96.5

Programming is now complete, and the unit can now be returned to the run mode, press **CANCEL** until **Run Mode?** Is displayed on the LCD press **ENTER**, and the FlowCERT will return to run mode.

Important Notice

If relay setpoints do not meet the exact requirements of the application, they can be modified to suit by pressing ENTER when, “For More Options Hit Enter”, is displayed, and entering new values to relay setpoints as required. Alternatively, access the setpoints by the main menu system or directly accessing the parameters.

BS3680 Flumes (P700 = 2)

Point of Measurement

The transducer must be above the **maximum head P704** by at least the near **blanking distance P107**.

For a **Rectangular** and **U-throated** flume, the head is measured at **3 to 4 times** the **maximum head upstream** from the beginning of the **converging section**, to ensure the surface of the liquid is not affected by turbulence.

(See DRWG 6)

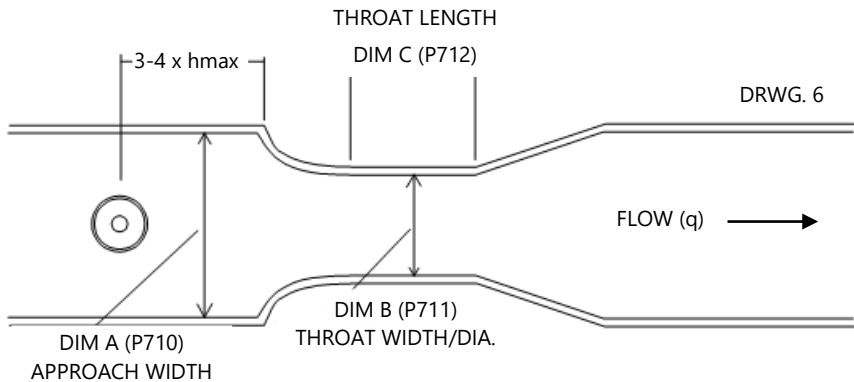

BS3680 FLUME

Calculations

Rectangular Flume

Absolute

If the flow calculation is to be **absolute P702 = 1** the flow will be calculated using the formula: $q = (2/3)^{1.5}gn^{0.5}C_sC_vC_dbh^{1.5}$

Where:

q = flowrate

gn = gravitational acceleration (nominal value = 980.66 cm/s²)

C_s = **shape coefficient** (value = 1)

C_v = **velocity coefficient** calculated by FlowCERT (P721)

C_d = **discharge coefficient** calculated by FlowCERT (P722)

b = **throat width P711**

h = head

Ratiometric

If the flow calculation is to be **ratiometric P702 = 2** the flow will be calculated using the formula: $q = q_{cal}(C_v/C_{vcal})(C_d/C_{dcal})(h/h_{cal})^{1.5}$

Where:

q = flowrate

q_{cal} = **flowrate at maximum head P705**

C_v = **velocity coefficient** calculated by FlowCERT (P721)

C_{vcal} = velocity coefficient at maximum head

C_d = **discharge coefficient** calculated by FlowCERT (P722)

C_{dcal} = discharge coefficient at maximum head

h = head

h_{cal} = **maximum head P704**

U-Throated Flume

Absolute

If the flow calculation is to be **absolute P702 = 1** the flow will be calculated using the formula: $q = (2/3)^{1.5} g_n^{0.5} C_u C_v C_d b h^{1.5}$

Where:

q = flowrate

g_n = gravitational acceleration (nominal value = 980.66 cm/s²)

h = head

C_u = **shape coefficient** calculated by FlowCERT (P724)

C_v = **velocity coefficient** calculated by FlowCERT (P721)

C_d = **discharge coefficient** calculated by FlowCERT (P722)

b = **throat width P711**

Ratiometric

If the flow calculation is to be **ratiometric P702 = 2** the flow will be calculated using the formula:

$$q = q_{cal} (C_v/C_{vcal}) (C_d/C_{dcal}) (C_u/C_{ucal}) (h/h_{cal})^{1.5}$$

Where:

q = flowrate

q_{cal} = **flowrate at maximum head P705**

C_v = **velocity coefficient** calculated by FlowCERT (P721)

C_{vcal} = velocity coefficient at maximum head

C_d = **discharge coefficient** calculated by FlowCERT (P722)

C_{dcal} = discharge coefficient at maximum head

C_u = **shape coefficient P724**

C_{ucal} = shape coefficient at maximum head

h = head **h_{cal}** = **maximum head P704**

Example 2 BS3680 U-Throated Flume

In this example, it is required to calculate to BS3680 the flow through a U-Throated Flume without any hump. Absolute calculation will be used, and there is a requirement for an alarm to indicate a low flow condition which will be set to relay 1. The flow rate is to be displayed in cubic meters/hour and the totaliser is also to record the flow in cubic metres, the resettable totaliser is to be displayed during RUN.

The distance from the face of the lower transducer (DUET) to **zero** flow (P105) is 35 inches and **max head (P704)** is 15 inches, **maximum flow(P705)** will be calculated by the FlowCERT as 0.1784 Mil USG/day

The dimensions of the flume are as follows:

Approach Channel diameter (Dim "A") P710 = 28 inches

Throat diameter (Dim "B") P711 = 20 inches

Throat length (Dim "C") P712 = 40 inches

To program the FlowCERT for **Example 2 BS3680 U-Throated Flume** by using the **Quick Setup** menu proceed as follows. If required access the **Program Mode**, key in the passcode 1997 and press **ENTER**. Using the 'right' arrow key, go to the **Quick Setup** menu press **ENTER** and as prompted, select the relevant option and press **ENTER**.

QUESTION	OPTION
PMD Type	2 = 3680 Flume
3680 Flumes	3 = U-Throat
Calculation	1 = Absolute
No. of alarms	1 = 1 Alarm
Type alarm 1	2 = Low
Alarm No.1	1 = Set to relay 1
Transducer	9 = DUET
Volume units	2 = Cubic metres
Time Units	4 = Per hour
Measurement units	1 = Metres
Empty level	1.00m
Minimum head	0.00m
Maximum head	0.40m
Totaliser enabled	1 = On
Totaliser (R)	1 = Yes
Totaliser multiplier	7 = 1000
Approach dia. (Dim A)	0.70m
Throat dia. (Dim B)	0.50m
Throat length (Dim C)	1.00m

Programming is now complete, and the unit can now be returned to the run mode, press **CANCEL** until **Run Mode?** Is displayed on the LCD press **ENTER**, and the **FlowCERT** will return to **Run Mode**.

Important Notice

If relay setpoints do not meet the exact requirements of the application, they can be modified to suit by pressing ENTER when, "For More Options Hit Enter", is displayed, and entering new values to relay setpoints as required. Alternatively, access the setpoints by the main menu system or directly accessing the parameters.

BS3680 Weirs (P700 = 3)

Point of Measurement

The transducer must be placed above the **maximum head P704** by at least the near **blanking distance P107**.

For a **Rectangular** and **V-notch** weir, the head is measured at a point 4 to 5 **times the maximum head upstream** from the weir plate, to ensure the surface of the liquid isn't affected by turbulence or drawdown. (See DRWG 7)

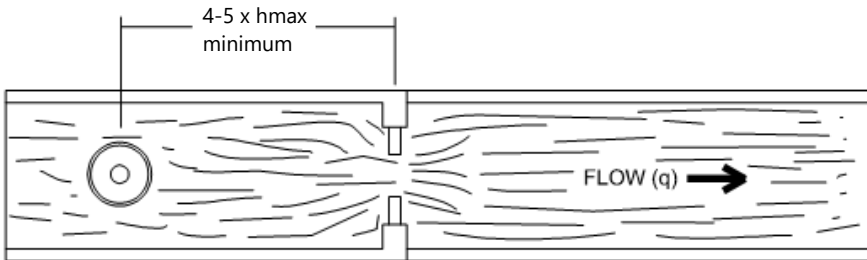

DRWG. 7

BS3680 WEIR

Calculations

BS3680 Rectangular Weir

Absolute

If the flow calculation is to be **absolute P702 = 1** the flow will be calculated using the formula: $q = C_e \frac{2}{3}(2gn)^{0.5} b_e h_e^{1.5}$

Where:

q = flowrate

Ce = **discharge coefficient** calculated by FlowCERT (P723)

gn = gravitational acceleration (nominal value = 980.66 cm/s²)

b_e = effective approach width where **b** is **approach width**

(Dim "A") **P710**

h_e = effective head

Ratiometric

If the flow calculation is to be **ratiometric P702 = 2** the flow will be calculated using the formula: $q = q_{cal}C_e/C_{ecal}(h_e/h_{ecal})^{1.5}$

Where:

q = flowrate

q_{cal} = flowrate at maximum head P705

C_e = discharge coefficient calculated by FlowCERT (P723)

C_{ecal} = discharge coefficient at maximum head

h_e = effective head

h_{ecal} = effective head at maximum head

*BS3680 V-Notch Weir**Absolute*

If the flow calculation is to be **absolute P702 = 1** the flow will be calculated using the formula: $q = C_e 8/15 \tan(\theta/2) (2gn)^{0.5} h^{2.5}$

Where:

q = flowrate

C_e = discharge coefficient calculated by FlowCERT (P723)

theta = V-notch angle

gn = gravitational acceleration (nominal value = 980.66 cm/s²)

h = head

The FlowCERT pre-sets the angle (theta) on selection of the chosen device this angle is **90°** for a BS 3680 **full 90°V notch** weir, **53° 8 minutes** in the case of the BS3680 **half 90°V notch** weir and **28° 4 minutes** in the case of the BS3680 **quarter 90°V notch**.

Ratiometric

If the flow calculation is to be **ratiometric P702 = 2** the flow will be calculated using the formula: $q = q_{cal}C_e(h)/C_e(h_{cal})(h/h_{cal})^{2.5}$

Where:

q = flowrate

q_{cal} = flowrate at maximum head P705

C_e(h) = discharge coefficient for head

C_e(h_{cal}) = discharge coefficient for maximum head

h = head

h_{cal} = maximum head P704

Example 3 BS3680 Rectangular Weir

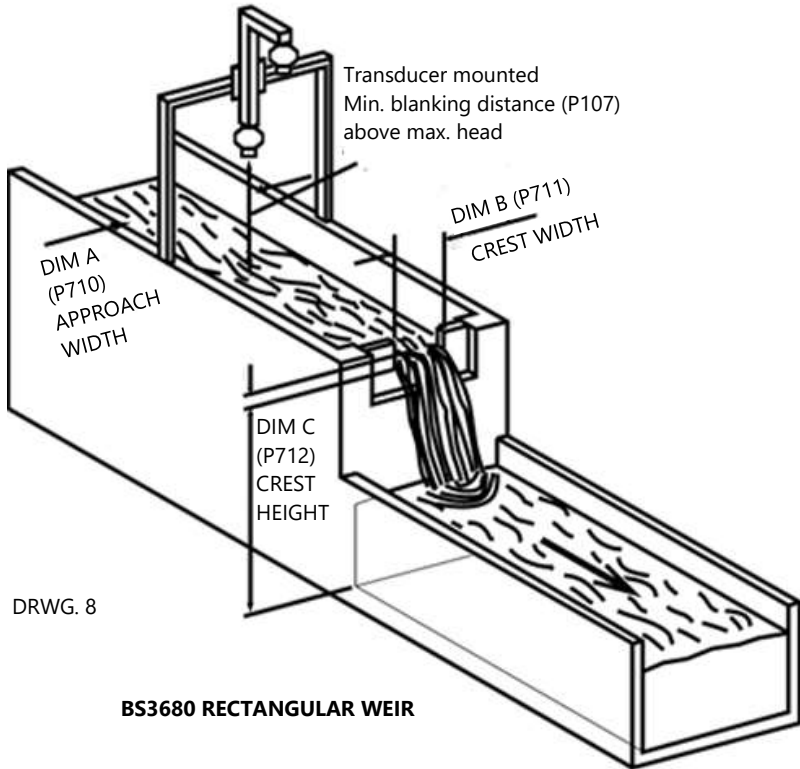

In this example, it is required to calculate to the flow through a BS3680 Rectangular weir. Absolute calculation will be used, and there is a requirement for an alarm to indicate a high flow condition to be set to relay 3. The flow rate is required to be displayed in litres/minute and the totaliser is to record the flow in cubic metres, the resettable totaliser is to be displayed during RUN.

The distance from the face of the lower transducer to **zero flow (P105)** is 1 metre and **max head (P704)** is 0.4 metres, **maximum flow (P705)**.

- Approach width (Dim "A") P710** = 18 inches
- Crest width (Dim "B") P711** = 12 inches
- Crest Height (Dim "C") P712** = 10 inches

To program the FlowCERT for **Example 3 BS3680 Weir** by using the **Quick Setup** menu proceed as follows. If required access the **Program Mode**, key in the passcode 1997 and press **ENTER**. Using the 'right' arrow key, go to the **Quick Setup** menu press **ENTER** and as prompted, select the relevant option and press **ENTER**.

QUESTION	OPTION
PMD Type	3 = 3680 Weir
3680 Flumes	1 = Rectangular
Calculation	1 = Absolute
No. of alarms	1 = 1 Alarm
Type alarm 1	1 = High
Alarm No.1	3 = Set to relay 3
Transducer	9 = DUET
Volume units	1 = Litres
Time Units	2 = Per minute
Measurement units	1 = Metres
Empty level	1.00m
Minimum head	0.00m
Maximum head	0.10m
Totaliser enabled	1 = On
Totaliser (R)	1 = Yes
Totaliser multiplier	7 = 1000
Approach dia. (Dim A)	0.50m
Crest Width. (Dim B)	0.30m
Crest Height (Dim C)	0.30m

Programming is now complete, and the unit can now be returned to the run mode, press **CANCEL** until **Run Mode?** Is displayed on the LCD press **ENTER**, and the FlowCERT will return to **Run Mode**.

Important Notice

If relay setpoints do not meet the exact requirements of the application, they can be modified to suit by pressing ENTER when, "For More Options Hit Enter", is displayed, and entering new values to relay setpoints as required. Alternatively, access the setpoints by the main menu system or directly accessing the parameters.

BS3680 Rectangular Broad Crested Weir

Point of Measurement

The transducer must be above the **maximum head P704** by at least the near **blanking distance P107**.

The head is measured at a point 3 to 4 **times** the **maximum head upstream** from the weir crest, to ensure the surface of the liquid is not affected by turbulence or drawdown.

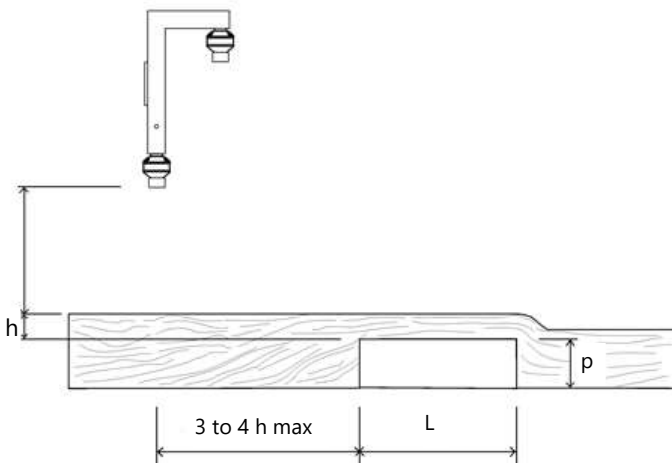

BROAD CRESTED WEIR

Calculations

Absolute

If the flow calculation is to be **absolute P702 = 1** the flow will be calculated using the formula: $q = (2/3)^{1.5} C_e b (gh^3)^{0.5}$

Where:

q = flowrate

C_e = **discharge coefficient** calculated by FlowCERT (P723)

b = approach width **P710**

g = gravitational acceleration (nominal value = 980.66 cm/s²)

h = head

Ratiometric

If the flow calculation is to be **ratiometric P702 = 2** the flow will be calculated using the formula: $q = q_{cal} C_e / C_{ecal} (h_e / h_{ecal})^{1.5}$

Where:

q = flowrate

q_{cal} = **flowrate at maximum head P705**

C_e = **discharge coefficient** calculated by FlowCERT (P723)

C_{ecal} = discharge coefficient at maximum head

h_e = effective head

h_{ecal} = effective head at maximum head

Area Velocity

The calculation of flow using Area Velocity is only possible when the velocity sensor is available to provide a signal input proportional to the velocity of flow and should be installed as detailed in [Chapter 4 Velocity Sensors](#).

Point of Measurement

The ultrasonic transducer used to measure the level of flow (head) must be above the **maximum head P704** by at least the near **blanking distance P107**.

For all **Area/Velocity** applications the point at which the head is measured should be chosen such that the surface of the liquid is is not affected by turbulence. (See DRWG 9, 10, 11 and 12).

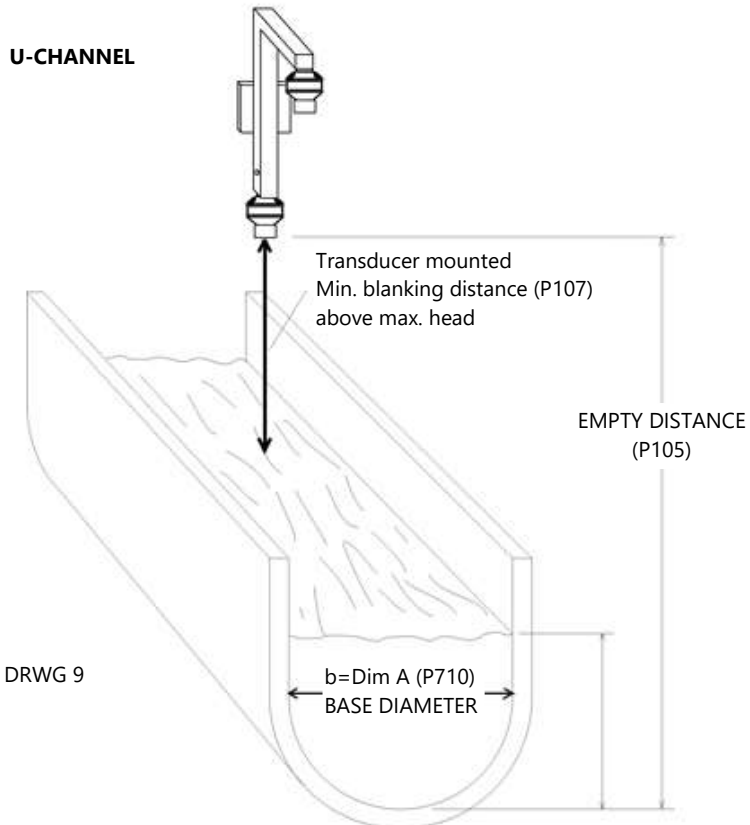

RECTANGULAR CHANNEL

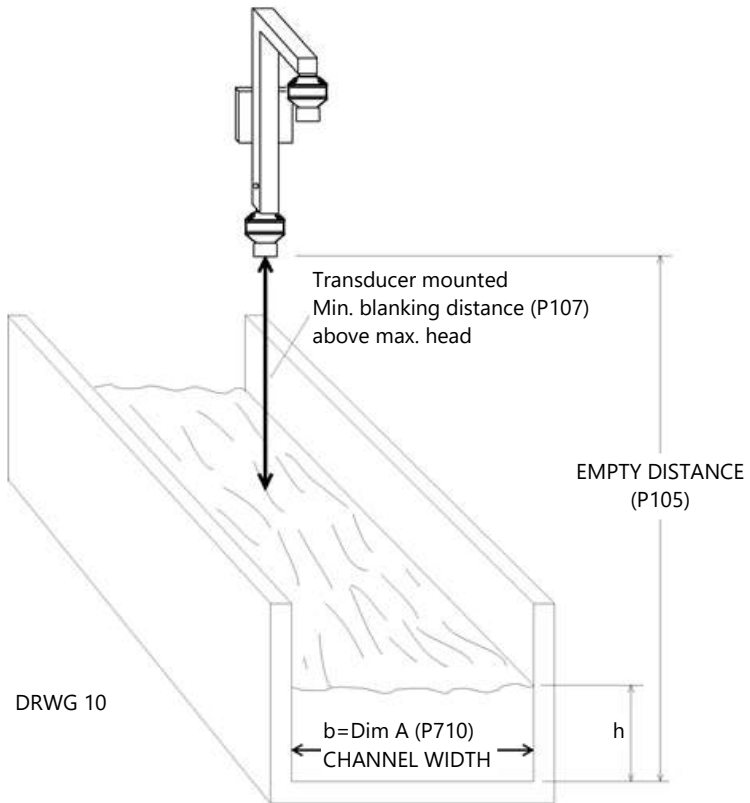
**Calculations***Absolute*

Rectangular and U-Channel - If the flow calculation is to be **absolute P702 = 1** the flow will be calculated using the formula: $q = v \times a(h)$

Where:

q = flowrate

v = velocity

$a(h)$ = area at head

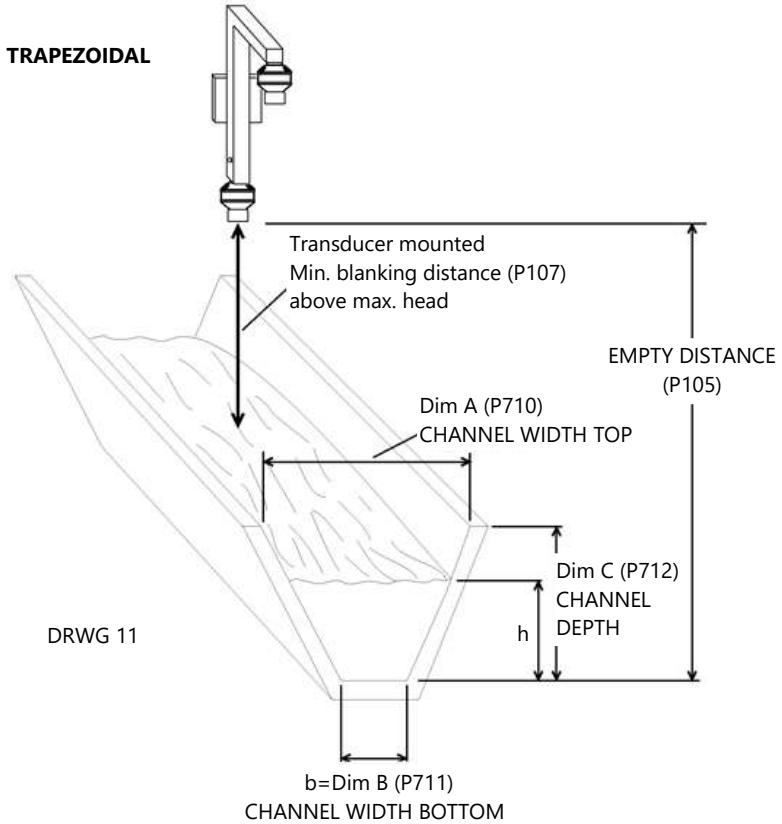

If the flow calculation is to be **absolute P702 = 1** the flow will be calculated using the formula: $q = vh (b + mh)$

Where:

q = flowrate

v = velocity

h = head

b = base width (Dim "B") P711

m = side slope calculated from

m = (B - b)/d where **B = channel top width (Dim "A") P710,**

b = base width (Dim "B") P711

d = depth of channel (Dim "C") P712

ROUND PIPE

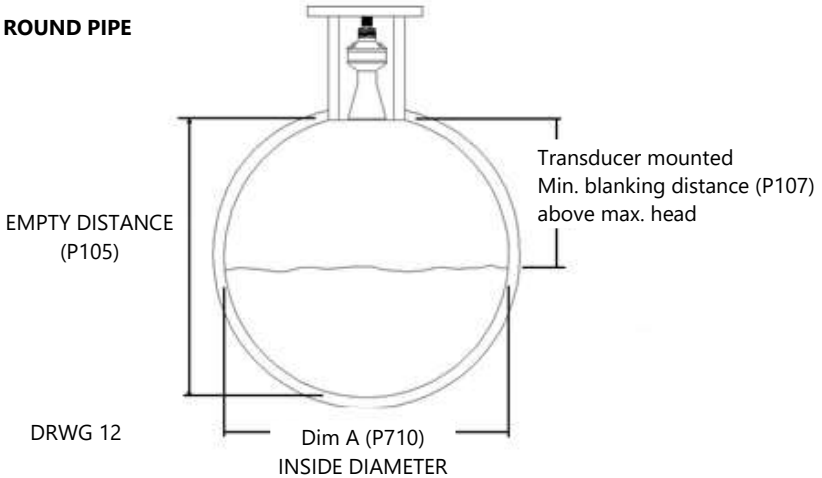

If the flow calculation is to be **absolute P702 = 1** the flow will be calculated using the formula: $q = va(h)$

Where:

q = flowrate

v = velocity

$a(h)$ = area at head

FIXED PIPE

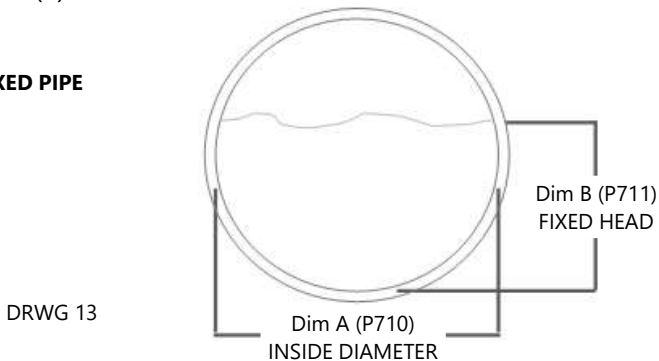

If the flow calculation is to be **absolute P702 = 1** the flow will be calculated using the formula: $q = va(h)$

Where: q = flowrate

v = velocity

$a(h)$ = area at head

Special Devices (P700 =5)

Point of Measurement

The transducer must be above the **maximum head P704** by at least the near **blanking distance P107**.

In the case of a **Palmer Bowlus** flume the point of head measurement should be **half** the value of **Dim "A" P710 upstream** of the device.

For an **H-Flume** the head measurement is taken at a point **downstream** from the flume entrance as detailed in the table below:

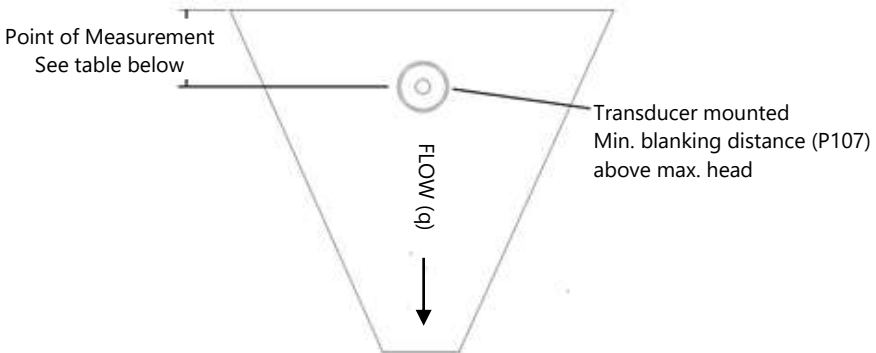

FLUME SIZE-DIM A (P710)		POINT OF MEASUREMENT	
cm	feet	cm	inches
15.25	0.5	4.7	1.88
23.00	0.75	6.7	2.69
30.05	1.0	9.1	3.63
45.70	1.5	13.5	5.378
61.00	2.0	17.9	7.19
76.20	2.5	22.5	9.00
91.45	3.0	27.2	10.88
137.15	4.5	40.5	16.19

V-notch angle weirs, the head is measured **upstream** of the weir plate at a minimum distance of **3 times maximum head** to ensure the surface of the liquid is not affected by turbulence or drawdown. See Exponential devices, above, for further details.

Calculations

Absolute

Palmer Bowls Flume and **H-Flume** - If the flow calculation is to be **absolute P702 = 1** the flow will be calculated using the formula: $q = f(h)$

Where:

q = flowrate

f = is an 8th degree polynomial solution for h (head)

Ratiometric

Palmer Bowls Flume and **H-Flume** - If the flow calculation is to be ratiometric $P702 = 2$ the flow will be calculated using the formula: $q = q_{cal} f(h)/f(h_{cal})$

Where:

q = flowrate

q_{cal} = flowrate at maximum head $P705$

$f(h)$ = a polynomial solution for h (head)

$f(h_{cal})$ = a polynomial solution for h_{cal} (maximum head)

V-Notch Angle Weir (Non-BS 3680)

Absolute

If the flow calculation is to be absolute $P702 = 1$ the flow will be calculated using the formula: $q = C_e 8/15 \tan(\theta/2)(2gn)^{0.5}(h = kh)^{2.5}$

Where:

q = flowrate

C_e = discharge coefficient calculated by FlowCERT (P723)

θ = V-notch angle

gn = gravitational acceleration

h = head

kh = compensated head

Ratiometric

If the flow calculation is to be **ratiometric P702 = 2** the flow will be calculated using the formula: $q = q_{cal} (h + kh / h_{cal} + kh)^{2.5}$

Where:

q = flowrate

q_{cal} = **flowrate at maximum head P705**

h = head

kh = compensated head

Universal Calculations (P700=6)

Point of Measurement

The transducer must be above the **maximum head P704** by at least the near **blanking distance P107**.

For all **Universal** calculation applications, the point at which the head is measured should be chosen such that the surface of the liquid is not affected by turbulence.

Calculations

Absolute

Universal Head Vs Flow - If the flow calculation is to be absolute P702 = 1 the flow will be calculated using the formula: $q = q(h)$

Where:

q = flowrate

q(h) = flowrate for head

The desired number of Breakpoints, (P730 - P793) are to be entered in pairs in values of head and corresponding flow. (Minimum of 2 pairs of Breakpoints is required).

Universal Calculations (P700=7)

Point of Measurement.

The transducer must be above the **maximum head P704** by at least the near **blanking distance P107**.

For all **Universal** calculation applications, the point at which the head is measured should be chosen such that the surface of the liquid is not affected by turbulence.

Calculations

Absolute

The calculations for the PMD options **Circular Straight, Rectangular, Trapezoidal, Round Pipe** and **Fixed Pipe** can be seen in the [Area Velocity](#) section of this manual. As well as entering the dimensions for the PMD you are also required to enter up to 32 breakpoints.

The desired number of Breakpoints, (P730 - P793) are to be entered in pairs in values of head and corresponding flow. (Minimum of 2 pairs of Breakpoints is required).

CHAPTER 7 PARAMETER GUIDE

This chapter describes all the parameters in your FlowCERT, as they appear in the menu system.

Menu System

Shown below is a set of charts to show you how all the various functions and features can be found using the menu system.

For further details and a full description of all parameters refer to the **Parameter Listings and Descriptions** section of this chapter.

Top Level Menu

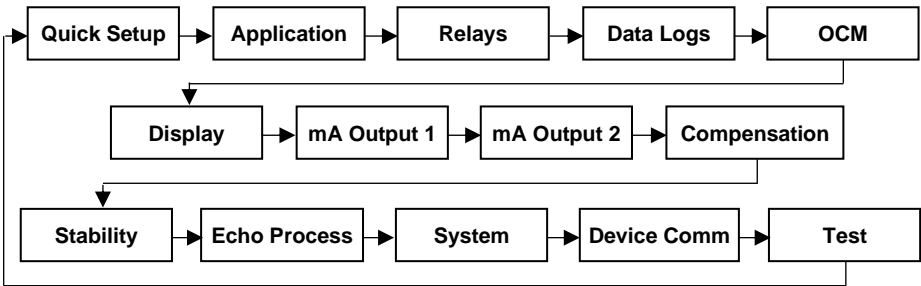

Application Menu

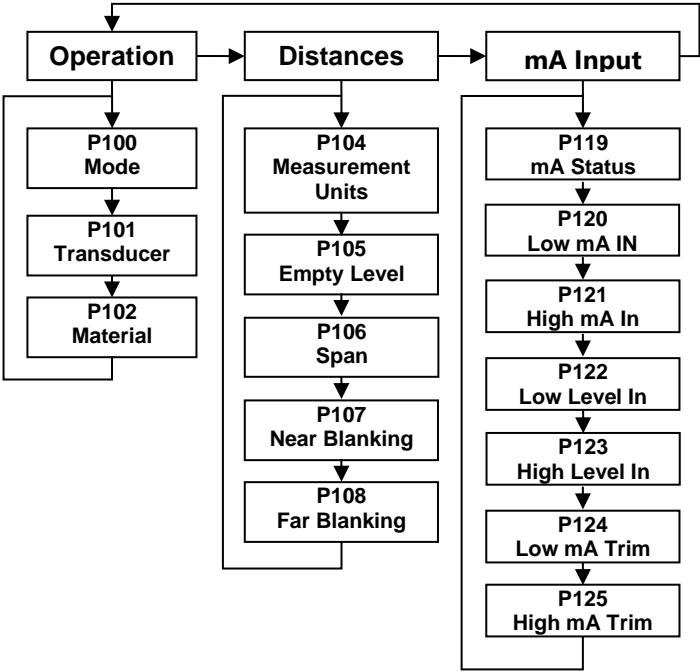

Relays Menu

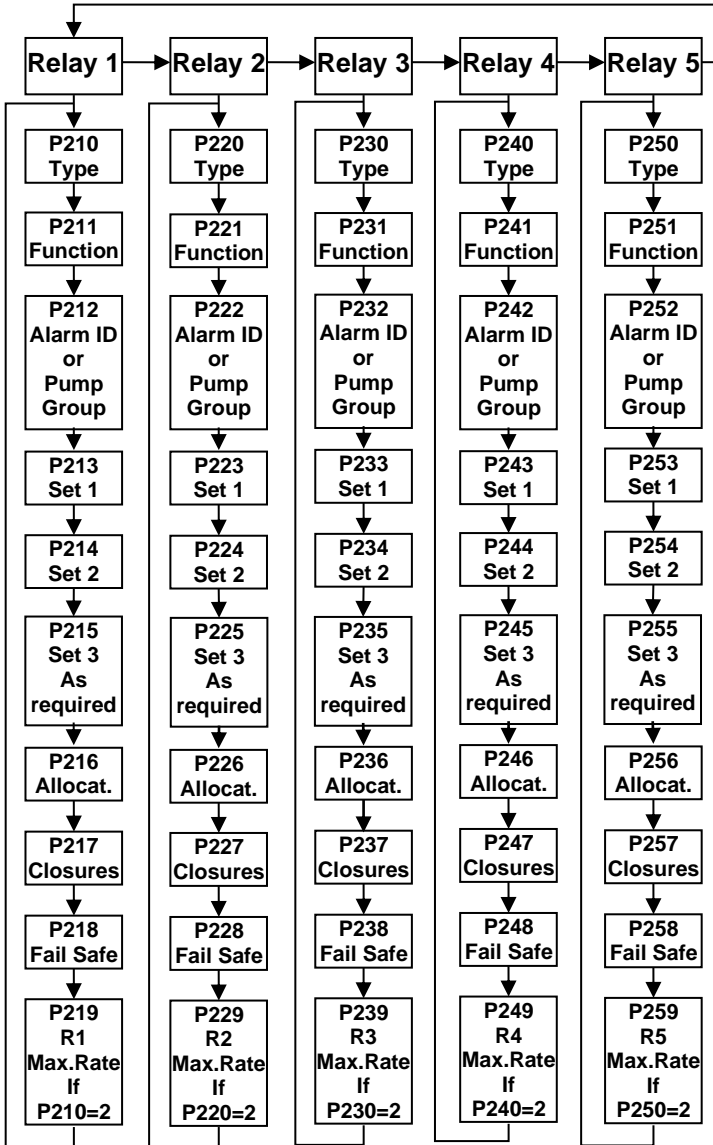

Data Logs Menu

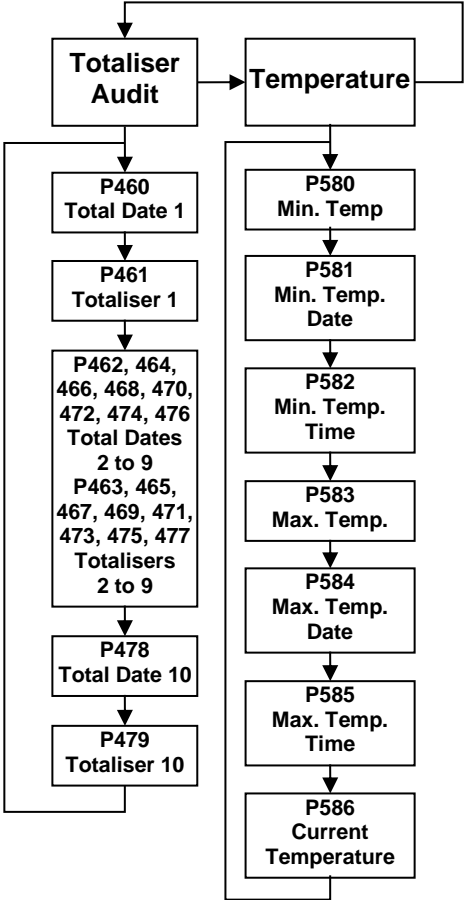

OCM Menu

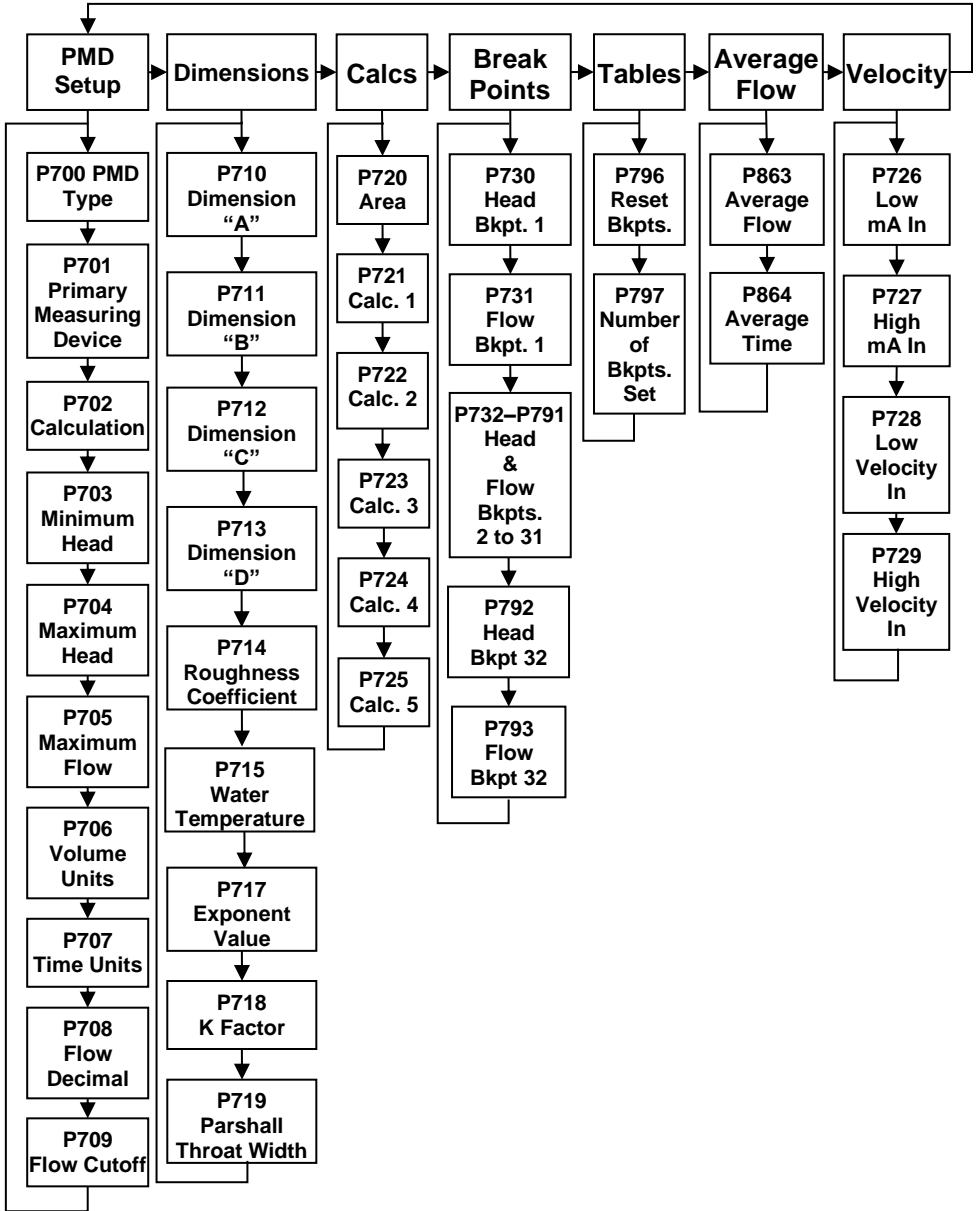

OCM Menu When P130 = 2 (Velocity)

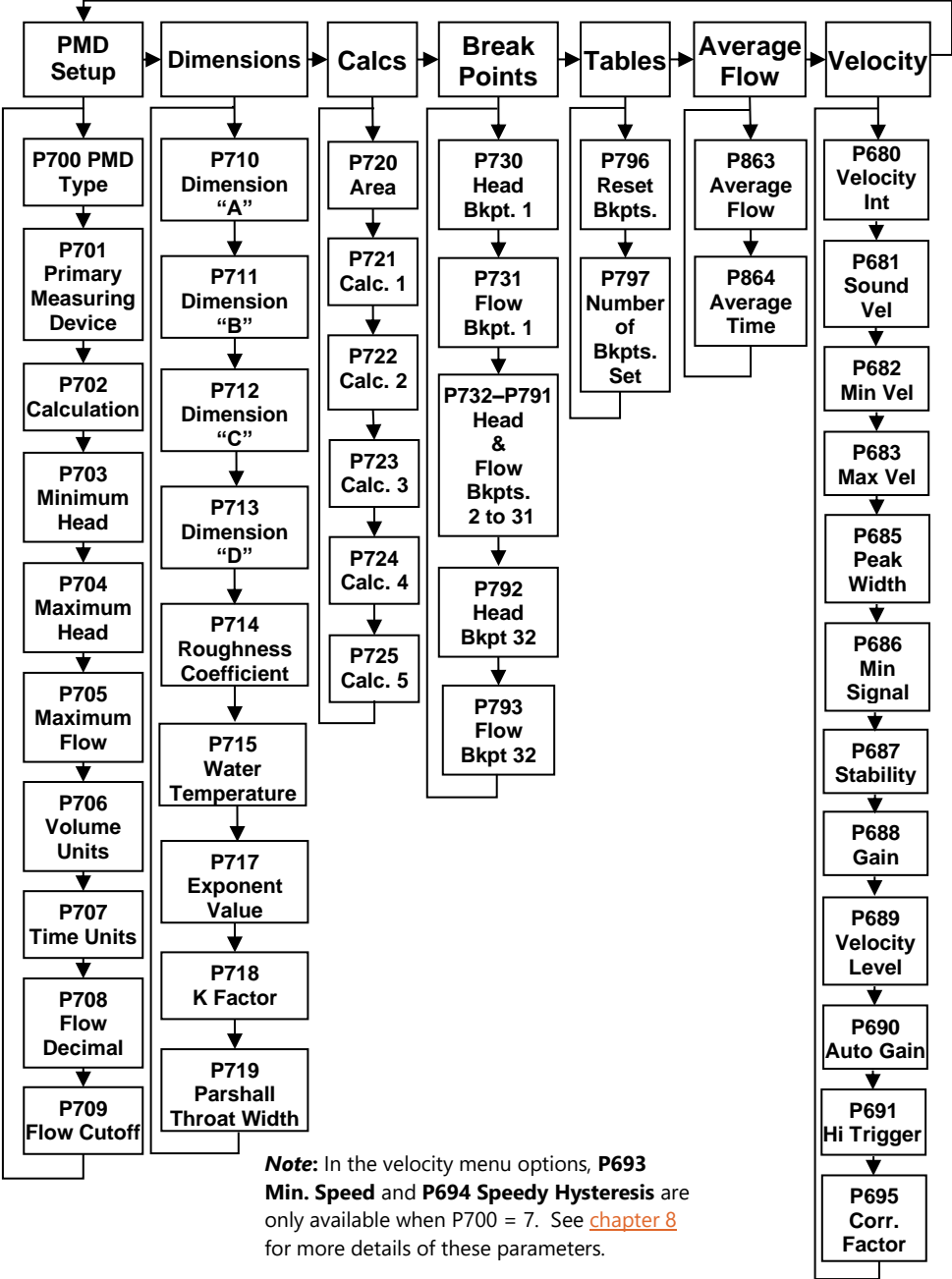

Display Menu

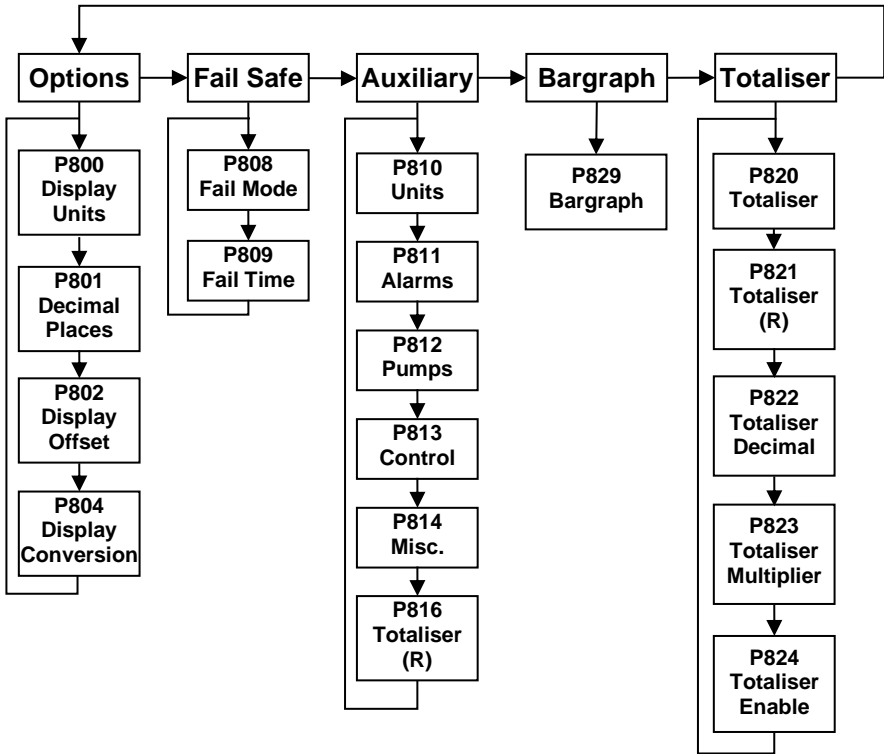

mA Output 1 Menu

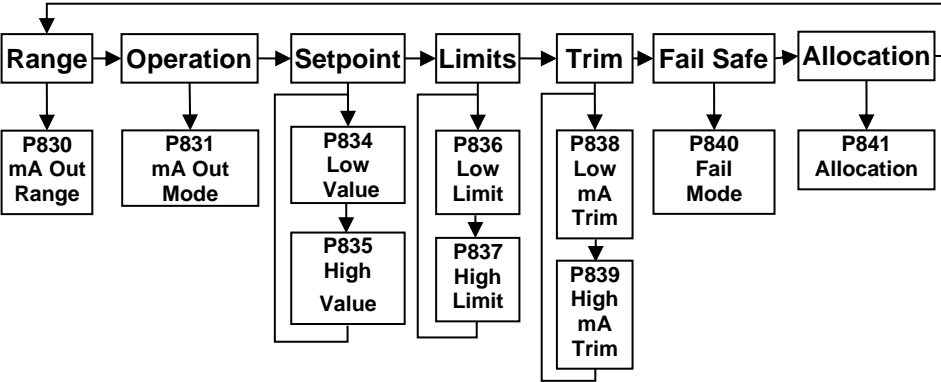

mA Output 2 Menu

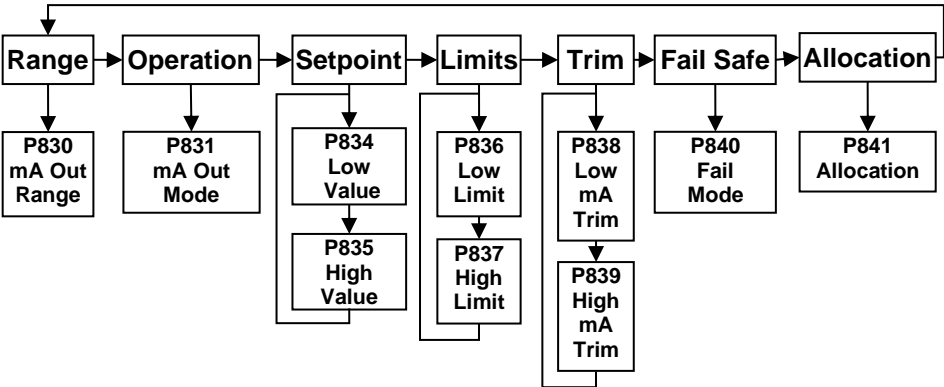

Compensation

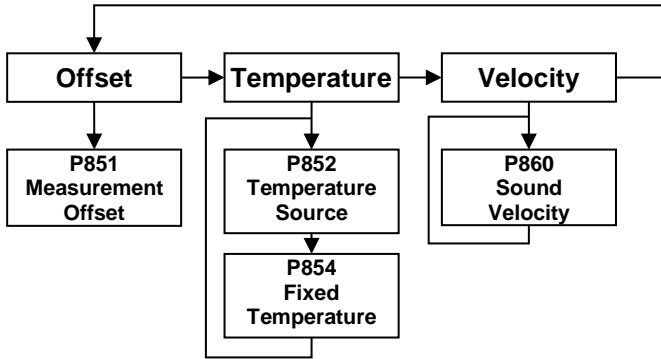

Stability Menu

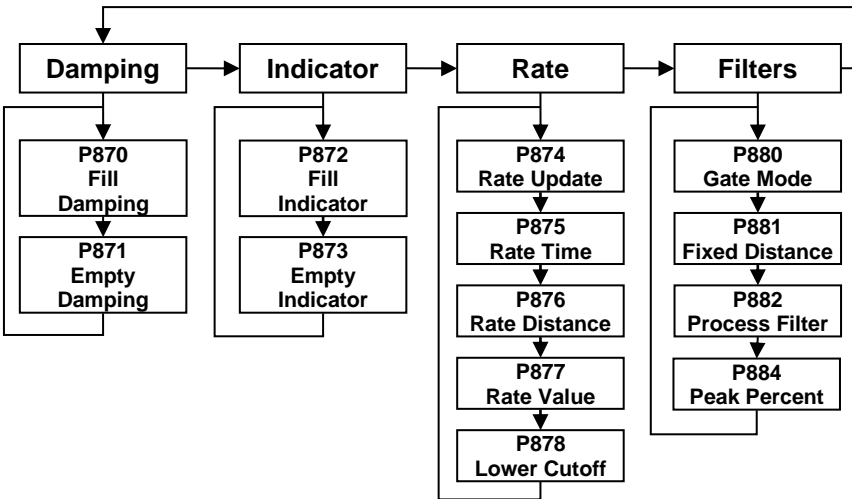

Echo Processing Menu

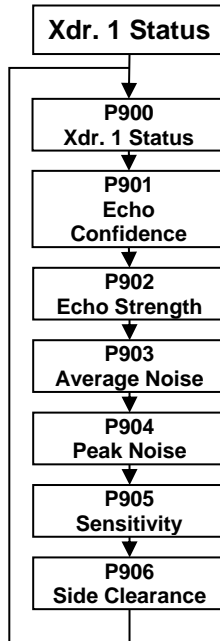

System Menu

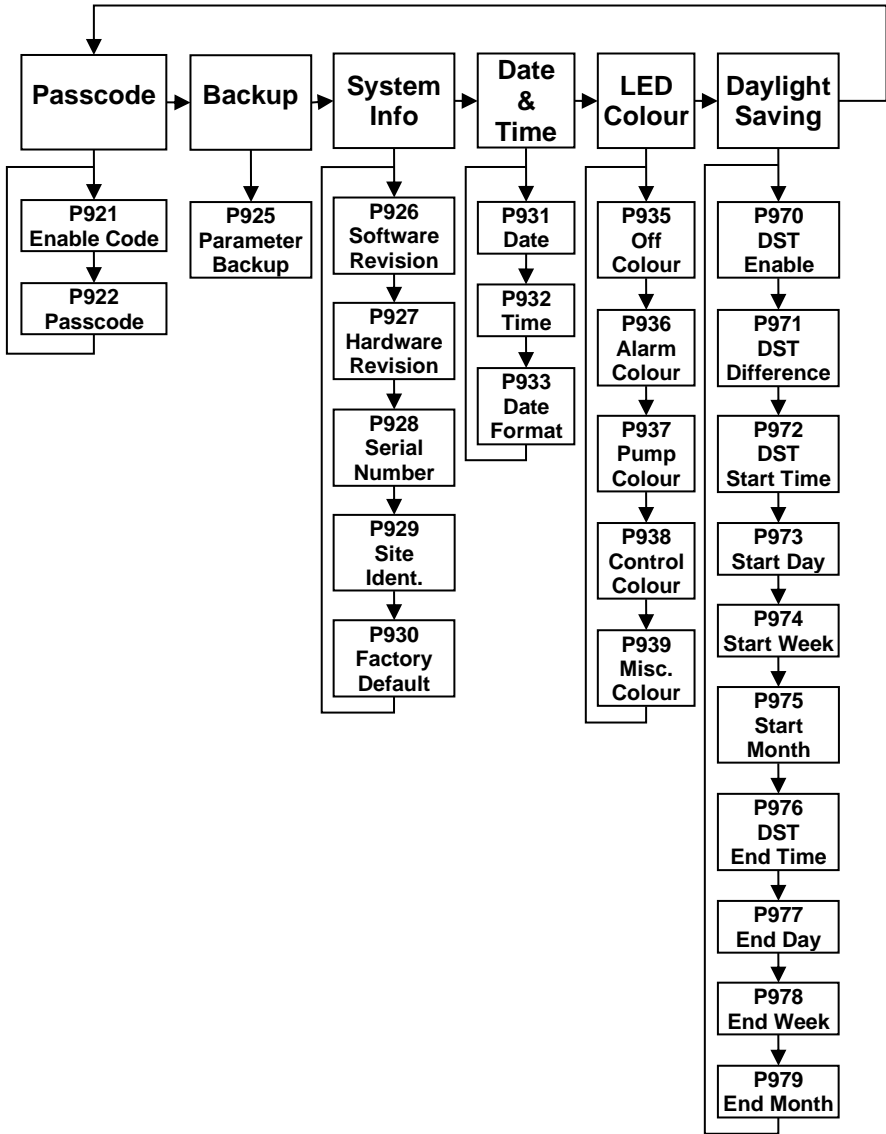

Device Comm Menu

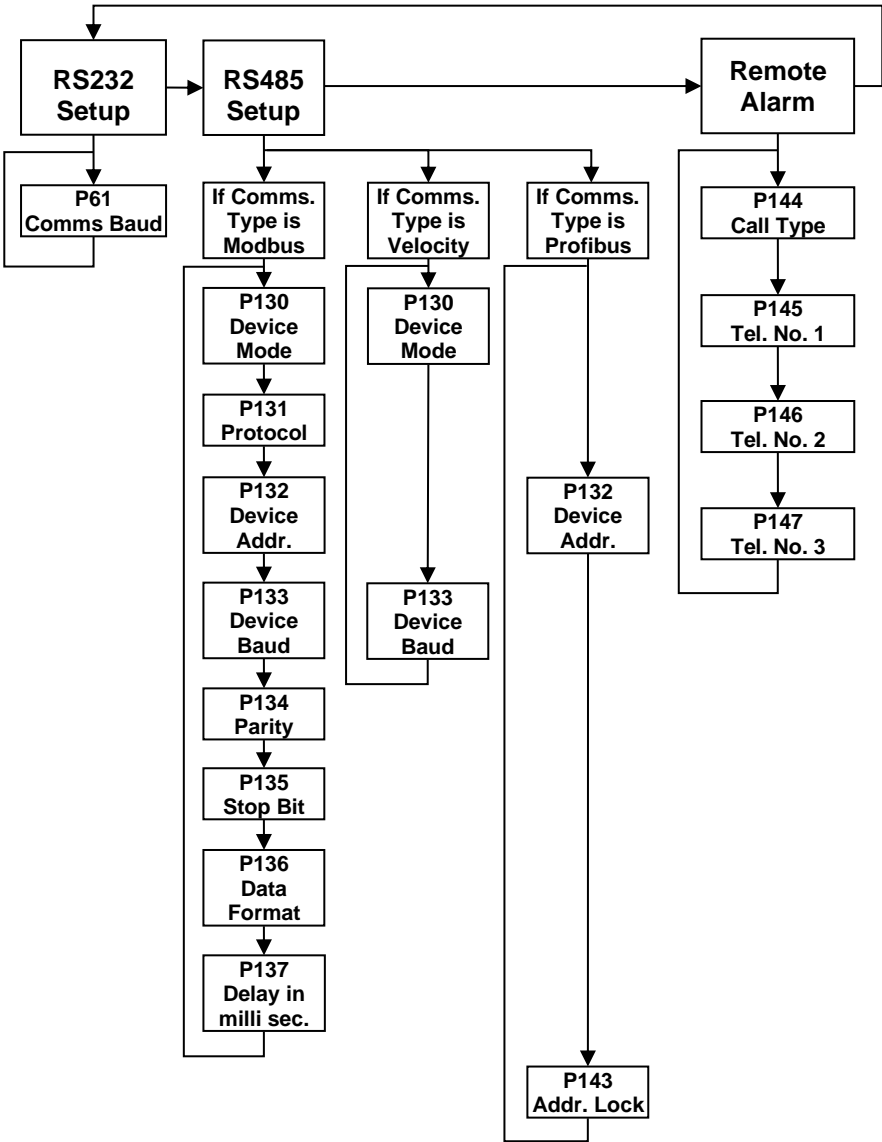

Test Menu

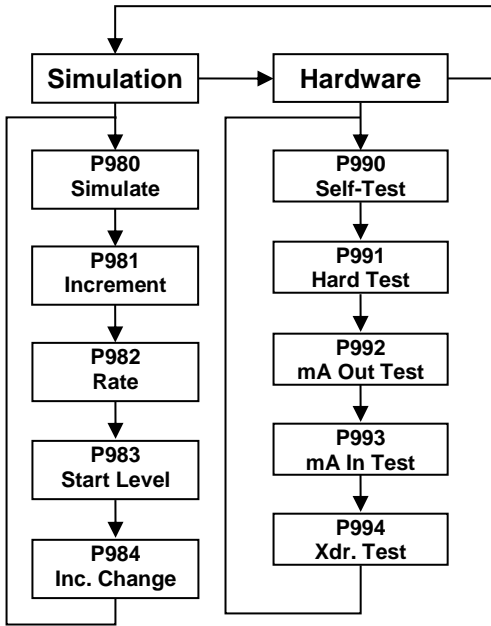

CHAPTER 8 PARAMETER LISTING AND DESCRIPTION

Application Parameters

Operation

P100 Mode of Operation

This parameter sets the mode of operation, when in run mode, and can be set to one of the following:

OPTION	DESCRIPTION
1 = Distance (Default)	Display shows the distance from the transducer face to the surface of the material measured.
2 = Level	Shows how full a vessel is.
3 = Space	Shows how empty a vessel is.
4 = OCM Head	Display shows how high the head is.
5 = OCM Flow	Display shows the instantaneous flow.

P101 Xducer (Transducer)

This parameter should be set to the transducer being used with the unit, and can be set to one of the following:

OPTION	DESCRIPTION
0 = Auxiliary	Use an alternative mA input device to provide level input, e.g. Pressure transducer
1 = dB Mach3	Transducer is a dB Mach3. Range = 0 to 2.425 metres
2 = dB6	Transducer is a dB6. Range = 0.3 to 6.00 metres
3 = dB10	Transducer is a dB10. Range = 0.3 to 10 metres
4 = dB15	Transducer is a dB15. Range = 0.5 to 15.00 metres
7 = dB S6	Transducer is a dB S6. Range = 0.2 to 6.00 metres
9 = Duet (Default)	Transducer is a Duet. Range 0.3 to 1.50 metres
*11 = dB R16	Transducer is a mmWAVE radar. Range = 0.077 to 16 metres
*12 = dB R8	Transducer is a mmWAVE radar. Range = 0.077 to 8 metres

Important Notice

*Please consult your local Pulsar distributor for the versions of firmware that the mmWAVE radars are available in.

P102 Material

This parameter should be set to the type of material being monitored.

OPTION	DESCRIPTION
1 = Liquid (Default)	Used for liquids and flat solid materials.
2 = Solid	Used for sold material that is heaped or at an angle.
3 = Closed Tank	Use for applications within a closed tank or where a secondary echo response may become focused to create a larger echo than the first.

Dimensions

P104 Measurement Units

This parameter sets the units you want to use for programming and display.

OPTION	DESCRIPTION
1 = metres (Default)	All units of measurement are Metres
2 = cm	All units of measurement are Centimetres
3 = mm	All units of measurement are Millimetres
4 = feet	All units of measurement are Feet
5 = inches	All units of measurement are Inches

P105 Empty Level

This parameter is to be set to the **maximum distance** from the **face** of the transducer to the **empty point**, in **P104 Measurement Units**. Note this value affects span as well, (see the following important information notices), so should be set before span.

Important Notice

When changing the Empty Distance (P105) you can also recalculate the values for the Span so that it equals the empty distance (P105) minus Near Blanking (P107) and the Relay Setpoints, so that they remain at the same percentage values of the empty distance as they were before you changed the empty distance (P105). You'll be asked the question "Recalculate Span?" Yes (enter 1), Span is then recalculated. Any other answer will leave the span at its original value. You'll then be asked if you want to "Recalculate Setpoints?", if you choose yes (enter 1), all Relay Setpoints will be recalculated as a % of the new empty distance. Any other answer will leave the setpoints at their original values.

Important Notice

When using **DUET**, the **empty distance** is measured from the face of the **lower transducer** to the **empty point** in **P104 Measurement Units**.

When using the **dB Mach 3** the **empty distance** is measured from the end of the **horn** to the **empty point** in **P104 Measurement Units**.

P106 Span

This parameter should be set to the maximum distance from the **Empty Level (P105)** to the maximum material level. It is automatically set to be equal to the **Empty Level (P105)** less the **Near Blanking distance (P107)** when you set the empty level.

P107 Near Blanking

This parameter is the distance from the face of the transducer that is not measurable and is pre-set to the minimum value dependant on the **Transducer (P101)** selected. It should not be set to less than this figure, but can be increased, typically to ignore close in obstructions.

TRANSDUCER	NEAR BLANKING DISTANCE
P101 = Auxiliary	Default blanking distance = 0.00 metres
P101 = dB Mach3	Default blanking distance = 0.00 metres
P101 = dB6	Default blanking distance = 0.30 metres
P101 = dB10	Default blanking distance = 0.30 metres
P101 = dB15	Default blanking distance = 0.50 metres
P101 = dB S6	Default blanking distance = 0.20 metres
P101 = Duet (Default)	Default blanking distance = 0.30 metres
P101 = dB R16	Default blanking distance = *0.077 metres
P101 = dB R8	Default blanking distance = *0.077 metres

*The signal emanates from the curved face of the radar, but for the purposes of measurement it is taken from the drip shield.

P108 Far Blanking Distance

This is the distance (as a percentage of the **empty level P105**) beyond the empty point that the unit will be able to measure, and by default is pre-set to 20% of the empty level.

If the surface being monitored can be extended beyond the **empty level (P105)** then the far blanking distance can be increased to a max. of 100% of the empty level, provided it does not exceed the max range of the transducer being used. This parameter is always entered as a % of the empty level.

mA Input

The 4-20mA (Auxiliary) input can be used to replace the transducer for applications where an ultrasonic transducer cannot be used.

P119 mA Status

If P101 = Auxiliary

This indicates the current state of the auxiliary input if it has been selected:

OPTION	DESCRIPTION
0 = mA OK (Default)	mA input is present and functioning correctly
1 = mA Open	No input device is being detected
2 = Short	Input is indicating a fault condition

P120 Low mA In

This parameter sets the current input figure that represents empty when using the optional current input, instead of an ultrasonic transducer.

Default = 4ma

P121 High mA In

This parameter sets the current input figure that represents (full) span when using the optional current input, instead of an ultrasonic transducer.

Default = 20ma

P122 Low Level In

This parameter sets the distance (in **P104 measurement units**) to empty point when using the optional current input, (Aux. input) instead of an ultrasonic transducer.

P123 High Level In

This parameter sets the distance (in **P104 measurement units**) that is full (span) when using the optional current input, (Aux. input) instead of an ultrasonic transducer.

P124 Low mA Trim

This parameter allows you to “calibrate” the FlowCERT to the **Low mA Input** from the device being used. If the expected low value, from the device connected to the mA Input, is not displayed, then you can trim it using this parameter.

P124 High mA Trim

This parameter allows you to “calibrate” the FlowCERT to the **High mA Input** from the device being used. If the expected high value, from the device connected to the mA Input, is not displayed, then you can trim it using this parameter.

Relay Parameters

All relay related parameters are prefixed with a **2****.

The second digit of the three-figure parameter number denotes the relay number as follows:

- 2**1*** parameters for Relay **1**
- 2**2*** parameters for Relay **2**
- 2**3*** parameters for Relay **3**
- 2**4*** parameters for Relay **4**
- 2**5*** parameters for Relay **5**

The third digit selects specific parameter for the setting of the relays, which can be selected individually and results in the following parameter numbers for each relay:

- Relay 1 2**10** to 2**18**
- Relay 2 2**20** to 2**28**
- Relay 3 2**30** to 2**38**
- Relay 4 2**40** to 2**48**
- Relay 5 2**50** to 2**58**

P210, 220, 230, 240, 250 - Relay Type

This parameter defines what type each relay should be, see the table below for available options:

OPTION	DESCRIPTION
0 = Not in use (Default)	Relay is not in use or programmed and the LED will always be off.
1 = Alarm	Relay is programmed as an alarm relay, which will de-energise ON , and energise OFF . This will ensure an alarm is raised if the power fails to the unit.
2 = Pump	Relay is programmed as a pump relay, which will energise ON , and de-energise OFF .
3 = Control	Relay is programmed as a control relay, which will energise ON , and de-energise OFF .
4 = Miscellaneous	Relay is programmed as a miscellaneous relay, which will energise ON , and de-energise OFF .

Alarms

P210, 220, 230, 240, 250 = 1 (Alarm)

The **second parameter** for each relay determines the **function** of the alarm.

P211, 221, 231, 241, 251 – Relay Function

OPTION	DESCRIPTION
0 = Off (Default)	Relay will not operate.
1 = Alarm	Alarm is based on the level in the vessel, and the type of level alarm (P212, 222, 232, 242, 252) and two setpoints must be set (P213, 223, 233, 243, 253 & 214, 224, 234, 244, 254). Setpoints are entered in display units or % of span as referenced to empty level.
2 = Rate of Change	Alarm is based on the rate of change of level in the vessel, and the type of rate of change alarm (212, 222, 232, 242, 252), and two setpoints must be set (213, 223, 233, 243, 253 & 214, 224, 234, 244, 254). Setpoints are entered in Display Units per minute or % of span per minute and a negative value should be entered for a Rate Alarm on a de-creasing level, and a positive value for an increasing level.
3 = Temperature	Alarm is based on the temperature, and the type of temperature alarm (P212, 222, 232, 242, 252) and two setpoints must be set (P213, 223, 233, 243, 253 & P214, 224, 234, 244, 254). The temperature used depends on the temperature source selected (P852). Setpoints entered in °C.
4 = Loss of Echo	Alarm is raised if the Failsafe Timer (P809) expires. No setpoints are required.
5 = Loss of Clock	Alarm is raised if the expires. No setpoints are required.
11 = Flow	Alarm is based on flow, when available and the ID of the alarm. Both setpoints must be set (P213, 223, 233, 243, 253 & P214, 224, 234, 244, 254). Setpoints are entered in the display units of flow.
12 = Velocity	Alarm is based on the velocity, when available, and the ID of the alarm. Both setpoints must be set (P213, 223, 233, 243, 253 & P214, 224, 234, 244, 254). Setpoints entered in m/s.
13 = Loss of Comms	Alarm is raised if there is a comms failure. No setpoints are required. <i>Available in firmware version 7.5.0 and greater</i>

Important Notice

The Loss of Echo, Loss of Clock and Loss of Comms will also be shown on the display as “Lost Echo”, Lost Clock” and Lost Comm” respectively.

The third parameter for each relay determines the **Alarm ID** for the relay you wish to set.

P212, 222, 232, 242, 252 – Relay Alarm ID

When P211, 221, 231, 241, 251 =4 (Loss of Echo) or 5 (Loss of Clock)

This parameter has no function and will not be displayed.

P211, 221, 231, 241, 251 = 1 (Level), 2 = Rate of Change or 3 (Temp)

This parameter defines which **alarm type**, or **identification**, the relay should respond to, as follows:

OPTION	DESCRIPTION	SETPOINTS
1 = General (Default)	Relay goes “ON” when the value reaches the ON setpoint and goes “OFF” when the value reaches the OFF setpoint.	P213, 223, 233 is ON Setpoint. P214, 224, 234 is OFF Setpoint
2 = High	Relay goes “ON” when the value rises to the ON setpoint and goes “OFF” when the value lowers to the OFF setpoint.	ON > OFF Relay Setpoints P213, 223, 233 and P214, 224, 234 Setpoints, can be set in any order as the unit ‘knows’ that you are setting a high-level alarm.
3 = HiHi	Same as 2 = High, but different identifier	
4 = Low	Relay goes “ON” when the value lowers to the ON setpoint and goes “OFF” when the value rises to the OFF setpoint.	ON < OFF Relay Setpoints P213, 223, 233 and P214, 224, 234. Setpoints, can be set in any order as the unit ‘knows’ that you are setting a low-level alarm.
5 = LoLo	Same as 4 = Low, but different identifier	

OPTION	DESCRIPTION	SETPOINTS
6 = In bounds	Relay goes "ON" if value is inside the zone between the two setpoints.	Relay Setpoints, P213, 223, 233 and P214, 224, 234 can be set in any order as the unit 'knows' that you are setting an inbounds alarm.
7 = Out of bounds	Relay goes "ON" if value is outside the zone between the two setpoints.	Relay Setpoints P213, 223, 233 and P214, 224, 234 can be set in any order as the unit 'knows' that you are setting an out of bounds alarm.

The **fourth parameter** and the **fifth parameter** for each relay set the **Alarm "ON"** and **"OFF"** points. For a **high alarm**, the **"ON"** is set **higher than "OFF"**. For **low alarm** then **"ON"** is set **lower than "OFF"**. See the appropriate **alarm ID**, table (**P212, 222, 232**) for further information.

When P211, 221, 231, 241, 251 = 4 (Loss of Echo) or 5 (loss of Clock)

This parameter has no function and will not be displayed.

When P211, 221, 231, 241, 251 = 1 (Level), 2 (Rate of Change), 3 (Temp), 11 (Flow) or 12 (Velocity).

P213, 223, 233, 243, 253 – Relay Setpoint 1

Determines the **'ON'** or **'OFF'** point for the alarm according to the **ID** selected.

P214, 224, 234, 244, 254 – Relay Setpoint 2

Determines the **'ON'** or **'OFF'** point for the alarm according to the **ID** selected.



To set figures in % press the  hotkey to show and enter % figure, relative to empty level.

Important Notice

Setpoints are entered in values according to the **function** selected.

Level - entered in Display Units or % of span as referenced to Empty Level.

Rate of Change - entered in Display Units per minute or % of span per minute.

For an alarm on an increasing level enter setpoints as a positive value, for an alarm on a decreasing level enter setpoints as a negative value.

Temperature - entered in °C.

See the appropriate **alarm function**, table (P211, 221, 231) for further information.

Pumps

P210, 220, 230, 240, 250 = 2 (Pump)

When a relay is being used for a **pump** function, the **second parameter** determines the **pump duty** that will be used to determine the operating cycle.

P211, 221, 231, 241, 251 – Relay Function

This parameter defines which **pump duty** the relay should respond to as follows:

PUMP DUTY	DESCRIPTION
0 = Off (Default)	Relay is always de-energised
1 = Fixed duty assist	All pumps are used to assist each other (run at the same time) and each pump has its own setpoints. (P213, 223, 233, 243, 253 & P214, 224, 234, 244, 254).
2 = Fixed duty backup	If a pump fails to meet the demand (due to malfunction, intake blockage etc.), then it is stopped, and another pump shall take over. Each pump has its own setpoints. (P213, 223, 233, 243, 253 & P214, 224, 234, 244, 254).
3 = Alternate duty assist	All pumps are used to assist each other (run at the same time). Each pump has its own setpoints, (P213, 223, 233, 243, 253 & P214, 224, 234, 244, 254) but each time all pumps have stopped, the setpoints are sequentially rotated between the pumps to ensure equal pump use.
4 = Alternate duty backup	If a pump fails to meet the demand (due to malfunction, intake blockage etc.), then it is stopped, and another pump shall take over. Each pump has its own setpoints, (P213, 223, 233, 243, 253 & P214, 224, 234, 244, 254) but each time all pumps have stopped, then the setpoints are sequentially rotated between the pumps to ensure equal pump use.

PUMP DUTY	DESCRIPTION
5 = Duty backup and assist	<p>First pump comes on, if it cannot cope, it goes off and next pump comes on (duty backup). This continues until the last pump comes on and if it cannot cope the first pump comes back on to assist the last pump (duty assist) if the level continues to rise all other pumps will come on (assist) in turn until the level decreases to the pump off points. Each pump has its own setpoints, (P213, 223, 233, 243, 253 & P214, 224, 234, 243, 253).</p>
6 = Service ratio duty assist	<p>All pumps are used to assist each other (run at the same time) and each pump has its own setpoints (P213, 223, 233, 243, 253 & P214, 224, 234, 244, 254). And a service ratio setting. The third setpoint (P215, 225, 235, 245, 255) is used to set the service ratio. Each time a pump is required to start then the pump with the least running hours (with respect to the service ratio) is started (i.e. the setpoints are re-assigned accordingly). For example, if two pumps A and B have the service ratio set to 2 and 1 respectively, then pump A will operate for twice as many hours as pump B.</p>
7 = Service ratio duty backup	<p>If a pump fails to meet the demand (due to malfunction, intake blockage and so on), then it is stopped, and another pump shall take over. Each time a pump is required to start then the pump with the least running hours (with respect to the service ratio) is started (i.e. the setpoints are re-assigned accordingly). Each pump has its own setpoints (P213, 223, 233, 243, 253 & P214, 224, 234, 244, 254). The third setpoint (P215, 225, 235, 245, 255) is used to set the service ratio. For example, if two pumps A and B have the service ratio set to 2 and 1 respectively, then pump A will operate for twice as many hours as pump B.</p>

PUMP DUTY	DESCRIPTION
8 = First On First Off Alternate duty assist	The first pump switched on is the first pump to be switched off, etc. regardless of the set points, so the setpoints are dynamically changed to enable this.
9 = Service Ratio Standby	When a service ratio duty is being used, on all other pumps in use, the standby pump can be started on a ratio basis only, when it will assume the setpoints of the next pump to start. The third setpoint (P215, 225, 235, 245, 255) is used to set the service ratio.
10 = Two Pump Sets	There are four pumps. Two rotate their start-up sequence with each other. If the two pumps cannot keep up, the level rise to the setpoints of the other two pumps which take over and rotate their sequence with each other.

Important Notice

The pumps are started and stopped at the “ON” and “OFF” setpoints. To *pump down* (reduce level) then set “ON” higher than “OFF”. To *pump up* (increase level) then set “ON” lower than “OFF”.

The **third parameter** for each relay determines the pump group. You can have two groups of pumps, and all similar duties within that group will operate together.

P212, 222, 232, 242, 252 – Relay Pump Group

By **default**, all pump groups are set to **1**, but if you want to have another group, then set this parameter to 2, for each pump relay that should operate together as part of a second group.

The **fourth parameter** and the **fifth parameter** for each relay set the **pump "ON"** and **"OFF"** points, which are entered in **Measurement units P104**. For **pump down** the **"ON"** is set **higher than "OFF"**. For **pump up** then **"ON"** is set **lower than "OFF"**. See the appropriate **pump duty**, function table (**P212, 222, 232, 242, 252**) for further information.

P213, 223, 233, 243, 253 – Relay Setpoint 1

This parameter determines the **'ON'** point of the pump.

P214, 224, 234, 244, 254 – Relay Setpoint 2

This parameter determines the **'OFF'** point of the pump.

The **sixth parameter** will determine the **service ratio** that will be used to switch the pump, when **pump duty** selected is a Service Ratio duty.

P215, 225, 235, 245, 255 – Relay Setpoint 3

This parameter determines the Service Ratio in values of %. See the appropriate **pump duty** function, table (**P211, 221, 231, 241, 251**), for further information.

P219, 229, 239, 249, 259 – Relay Max Rate

This parameter will allow a **pump** to be **switched** at a pre-determined **Rate of change of Level**, irrespective of the **"ON"** level setpoint P213, 223, 233, 243, 253. Once a pump relay has been switched **"ON"** by the pre-determined **Rate of Change**, it will remain energised until the level reaches the **"OFF"** level setpoint **P214, 224, 234, 244, 254**.

Max. Rate is entered in Measurement Units (P104) per minute and can be entered as either positive (increasing level) or negative (decreasing level) values.

Control

P210, 220, 230, 240, 250 = 3 (Control)

When a relay is being set up as a **control** relay, the **second parameter** that will be displayed in the menu determines its **function**.

P211, 221, 231, 241, 251 – Relay Function

This function allows the relay to be assigned to specific **control** functions (other than pumps and alarms) several of these functions work in relation to time.

This can be used to activate devices based on elapsed time or running cycles, such as a timed rake control to keep a ram lubricated if idle for long periods, or flush valve operation.

PUMP DUTY	DESCRIPTION
0 = Off (Default)	Relay is always de-energised
1 = Time	Relay will energise "ON" after the Cycle time that is set in Relay Setpoint 2 (P214, 224, 234, 244, 254). And turns "OFF", de-energises , after the On-Time Period that is set in Relay Setpoint 1 (P213, 223, 233, 243, 253)
2 = Step Time	Step Time Control allows relays to be used to control a device, such as a motorised valve or gate, in order to maintain the level within two predetermined points. Relays will energise "ON" when Step Time condition is in effect and de-energises "OFF" when Step Time goes off. One relay will be required to control an increase in level, ('open' the device) and a second relay is required to control a decrease in level, ('close' the device). Alarm ID (P212, 222, 232, 242, 252) is used to assign the relay to control either the open or close condition. Step Time Control relay requires three setpoints. The first set point (P213, 223, 233, 243, 253) determines the level , at which the relay is to be activated, (N.B. level setpoint for open relay, increase the level, must be lower than the setpoint for the close relay, decrease the level). The relay will energise "ON" after the Limit time that is set in Relay Setpoint 3 (P215, 225, 235, 245, 255). And turns "OFF", de-energises , after the Drive Period that is set in Relay Setpoint 2 (P214, 224, 234, 244, 254).

The **third parameter** for each relay determines the **assignment** or **condition** of the relay, where required.

P212, 222, 232, 242, 252 – Relay Alarm ID/Pump Group

P211, 221, 231, 241, 251 = 2 (Step Time)

If the relay is selected for Step Time, then this parameter is used to assign the relay to the 0 = **Open** condition (increase level) or 1 = **Close** condition (decrease level).

The **fourth parameter**, **fifth parameter** and **sixth parameter** are set to determine the switch points, "**ON**" and "**OFF**" for the relay and where required the order of start. See **control function**, table (**P211, 221, 231, 241, 251**) for further information.

P213, 223, 233, 243, 253 – Relay Setpoint 1

P211, 221, 231, 241, 251 = 1 (Time)

This parameter determines the "Time Period" that the relay will remain "ON". Relay Setpoints are entered in Minutes. See the appropriate relay function tables (P211, 221, 231, 241, 251) for further information.

P211, 2210, 231, 241, 251 = 2 (Step Time)

Relay Setpoint 1 is entered in values of Measurement Units (P104) See the appropriate relay function tables (P211, 221, 231, 241, 251) for further information.

P214, 224, 234, 244, 254 – Relay Setpoint 2

P211, 221, 231, 241, 251 = 1 (Time)

This parameter determines the "Cycle Time" for the operation of the relay. See the appropriate relay function tables (P211, 221, 231, 241, 251) for further information.

P211, 2210, 231, 241, 251 = 2 (Step Time)

Relay Setpoints are entered in Seconds to set Drive Period, the time that the relay will remain 'ON'.

See the appropriate relay Function tables (P211, 221, 231, 241, 251) for further information.

*P215, 225, 235, 245, 255 – Relay Setpoint 3***P211, 221, 231, 241, 251 = 2 (Step Time)**

This parameter is used to determine the Limit Time between each Drive Period. Relay Setpoints are entered in Minutes, during which time the relay will remain 'OFF'.

See the appropriate relay **Function** tables (**P211, 221, 231, 241, 251**) for further information.

Miscellaneous**P210, 220, 230, 240, 250 = 4 (Miscellaneous)**

When a relay is set to be a **miscellaneous relay**, the **second parameter** determines its **function**.

P211, 221, 231, 241, 251 – Relay Function

This function allows the relay to work in relation to a clock or a specific event and will be set to activate in relation to Real Time.

PUMP DUTY	DESCRIPTION
0 = Off (Default)	Relay is always de-energised
1 = Clock	Relay will energise ON at a specified time each day as set in Relay Setpoint 1 (P213, 223, 233, 243, 253). And turns OFF, de-energises , after the specified-On Time period as set in Relay Setpoint 2 (P214, 224, 234, 244, 254).
2 = Totaliser	Relay will energise ON momentarily each time the specified volume has passed as set in Relay setpoint 1 (P213, 223, 233, 243, 253), this parameter sets the multiplication factor which will be applied to the on-board totaliser (P820) to determine the switch point of the relay. E.g. if the totaliser is set to totalise in cubic metres and the relay is required to provide a closure every 10,000 litres Relay setpoint 1 would be set to 10. Relay setpoint 2 (P214, 224, 234, 244, 254) is used to select the time the relay will remain closed in seconds.

The **third parameter** has **no function** when **miscellaneous relay** is chosen and will not be displayed.

Important Notice

The pumps are started and stopped at the “ON” and “OFF” setpoints. To *pump down* (reduce level) then set “ON” higher than “OFF”. To *pump up* (increase level) then set “ON” lower than “OFF”.

The **fourth parameter**, and **fifth parameter**, are set to determine the switch points, “ON” and “OFF” for the relay. See **miscellaneous** function table (**P211, 221, 231, 241, 251**) for further information.

P210, 220, 230, 240, 250 = 1 (Clock)*P213, 223, 233, 243, 253– Relay Setpoint 1*

Relay Setpoints are entered in Hours & Minutes (HH:MM) to set Time at which relay will energise. Default = **00:00 (HH:MM)**

P214, 224, 234, 244, 254– Relay Setpoint 2

Relay Setpoints are entered in seconds to set the time period that the relay will remain ‘ON’. **Default = 0.00 secs.**

P210, 220, 230, 240, 250 = 2 (Totaliser)*P213, 223, 233, 243, 253– Relay Setpoint 1*

Relay Setpoints are entered as a factor by which the on-board totaliser (P820) should be multiplied by to provide a relay closure. **Default = 0.00**

P214, 224, 234, 244, 254– Relay Setpoint 2

Relay Setpoints are entered in seconds to set the time period that the relay will remain ‘ON’. **Default = 0.00 secs.**

P219, 229, 239, 249, 259 – Relay Max Rate

This parameter will allow a **pump** to be **switched** at a pre-determined **Rate of change of Level**, irrespective of the “ON” level setpoint P213, 223, 233, 243, 253. Once a pump relay has been switched “ON” by the pre-determined **Rate of Change**, it will remain energised until the level reaches the “OFF” level setpoint **P214, 224, 234, 244, 254**.

Max. Rate is entered in Measurement Units (P104) per minute and can be entered as either positive (increasing level) or negative (decreasing level) values.

Common Relay parameters

P216, 226, 236, 246, 256 – Relay Allocation

This parameter determines which input the relay will act on. You can set it to the transducer (default), or the optional auxiliary (current) input, or an average of the two. In most cases, this will not need to be changed from the default.

OPTION	DESCRIPTION
1 = Xducer 1 (Default)	Relay acts on Xducer 1 calculated values
2 = Auxiliary (optional)	Relay acts on optional current input levels

P217, 227, 237, 247, 257 – Relay Closures

The FlowCERT will record how many times each relay is closed, this parameter displays the number of times the relay has activated since the relay has been in use. It can be reset with any value.

P218, 228, 238, 248, 258 – Relay Fail Safe

The FlowCERT has a general fail-safe parameter **P808**. However, this can be overridden so that each individual relay has its own independent fail-safe mode.

This parameter determines what the relay will do in the event of the **Failsafe Time (P809)** expiring.

OPTION	DESCRIPTION
0 = Default	Relay assumes system default mode set in P808
1 = Hold	Relay remains in its current state
2 = De-energise	Relay will De-energise
3 = Energise	Relay will energise

Data Log parameters

The data log parameters contain the following information:

Totaliser Audits

P460 to P479 Total Audits

Parameters **P460-P479** show the **date** and total **flow** for the last **ten days**, the first on the list are the most recent and last ones are the oldest. When all ten total audits are full the oldest is pushed out and all totals increment through to allow the new days total to be registered in the first day's total audit parameter allocation.

Important Notice

The pumps are started and stopped at the "ON" and "OFF" setpoints. To pump down (reduce level) then set "ON" higher than "OFF". To pump up (increase level) then set "ON" lower than "OFF".

P480 Clear Logs

This parameter enables **all** of the Total Audits (P460 – P479) to be cleared to factory default values.

Temperature

The following parameters give information on temperature conditions seen by the **Temperature source (P852)** in °C. All of these parameters are read only and cannot be changed, though if P852 is changed they will be reset.

P580 Minimum Temperature

This parameter displays the minimum temperature recorded.

P581 Minimum Temperature Date

This parameter displays the date when the minimum temperature was recorded.

P582 Minimum Temperature Time

This parameter displays the time when the minimum temperature was recorded.

P583 Maximum Temperature

This parameter displays the maximum temperature recorded.

P584 Maximum Temperature Date

This parameter displays the date when the maximum temperature was recorded.

P585 Maximum Temperature Time

This parameter displays the time when the maximum temperature was recorded.

P585 Current Temperature

This parameter displays the current temperature.

OCM Parameters**PMD Setup***P700 Primary Measuring Device Type*

This parameter is used to select the **type of Primary Measuring Device** and enable additional parameters required to calculate the flow of the particular Primary Measuring Device chosen (P701). Options are as follows:

0 = Off (Default)

- 1 = Exponent
- 2 = BS3680 Flume
- 3 = BS3680 Weir
- 4 = Area/Velocity
- 5 = Special
- 6 = Universal

P701 Primary Measuring Device

Enter the Primary Measuring Device used:

If P700 = 1 Exponent

- 1 = Suppressed Rectangular Weir
- 2 = Trapezoidal (Cipolletti) Weir
- 3 = Venturi Flume
- 4 = Parshall Flume
- 5 = Leopold Lagco Flume
- 6 = V-Notch Weir
- 7 = Others
- 8 = Rectangular Weir with End contractions

If P700 = 2 BS3680 Flume

- 1 = Rectangular
- 2 = Rectangular with hump
- 3 = U-throated
- 4 = U-throated with hump

If P700 = 3 BS3680 Weir

- 1 = Rectangular
- 2 = V-Notch Full 90 degree (full 90°)
- 3 = V-Notch 53 degree 8' (half 90°)
- 4 = V-Notch 28 degree 4' (quarter 90°)
- 5 = Broad Crested (Rectangular) Weir

If P700 = 4 Area Velocity

The calculation of flow using Velocity Area is only possible when a velocity sensor is used to provide an input signal proportional to the velocity of the flow.

- 1 = Circular straight (U-channel), circular bottom, straight sides
- 2 = Rectangular
- 3 = Trapezoidal
- 4 = Round Pipe
- 5 = Fixed Pipe

If P700 = 5 Special

- 1 = Palmer Bowlus Flume
- 2 = H-Flume
- 3 = V-Notch angle (other than BS3680)

If P700 = 6 Universal

Where the Primary Measuring device does not match any of the devices contained in the above categories then a universal volume calculation can be performed. A head Vs flow chart is used, to enter a number of **Breakpoints** for head and flowrate (**P730-793**), which is either provided by the manufacturer or created based on the dimensions of the device.

- 1 = Universal Linear calculation
- 2 = Universal Curved flow calculation
- 3 = Universal Linear Area x Velocity (optional)
- 4 = Universal Curved Area x Velocity (optional)

If P700 = 7 Area Velocity Universal

When the water flow/velocity in the application falls to a certain level that the velocity sensor is unable to register a valid velocity, as set in **P693** (Min. Speed) by the amount set in **P694 (Speed Hysteresis)** flow calculations will switch to a pre-defined 32-point universal level to flow curve fit (**P730-793**).

- 1 = Circular straight (U-channel), circular bottom, straight sides
- 2 = Rectangular
- 3 = Trapezoidal
- 4 = Round Pipe
- 5 = Fixed Pipe

Example:

P683 Max velocity = 6 m/s

A = 6 m/s

P682 Min velocity = 0 m/s

B = 1.2 m/s

P693 Speed Min. Speed = 1 m/s

C = 0.8 m/s

P694 Speed Hysteresis = 0.2 m/s

D = -0.8 m/s

E = -1.2 m/s

F = -6 m/s

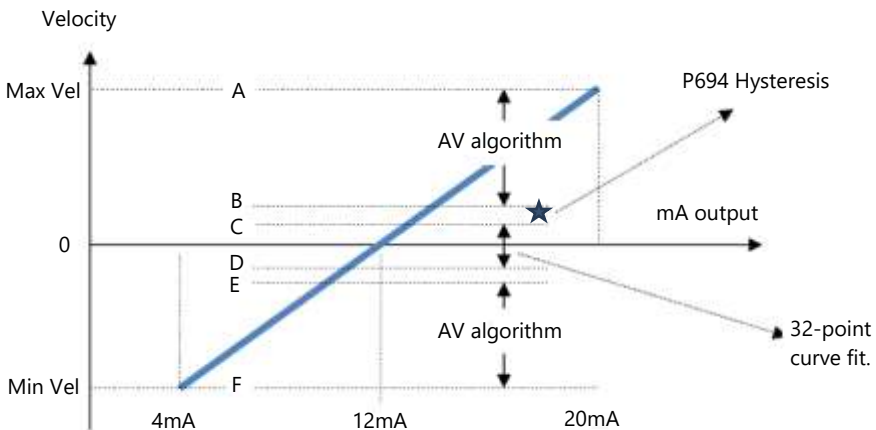

Assuming the velocity is positive and greater than 1.2 m/s i.e., the system operates in positive region between A and B. Flow rate will be positive which indicates forward flow and forward totaliser (P820, 821) will be incremented accordingly.

When the flow velocity falls below C (0.8 m/s), the calculation will be switched to a 32-point curve fit, which takes the level reading and outputs flow rate. The flow rate in this case is positive since it is the only direction available since it last registered. Therefore, the forward flow rate and totalisers will be registered. This continues as long as the flow velocity is above point E (-1.2 m/s).

There are 2 scenarios:

1. If the flow velocity rises above point B (1.2 m/s), the calculation will be reversed back to the AV algorithm, which calculates the flow according to Area x Velocity. The flow direction is still positive and hence the positive totalisers will be registered.
2. However, if the velocity continues to fall below point E (-1.2 m/s), the calculation will be reversed to AV algorithm, but the flow direction is now negative and negative totalisers (P504 – 506) will be registered. This will continue until flow velocity rises above point D (-0.8 m/s) when the 32-point curve fit will be reinstated.

Important Notice

P693 Speed Min. Speed and **P694 Speedy Hysteresis** are only available when **P700 = 7 A/V Universal**.

For further information please consult your local Pulsar distributor.

P702 Calculation

Select the required **calculation method**, both will give the same answer, but the difference is the information required to complete the calculation. For ratiometric it is normally sufficient to know the maximum flow at the maximum head. Choose between:

1 = Absolute

2 = Ratiometric (Default)

P703 Minimum Head

This parameter is used to enter the **distance**, above empty, that represents **zero head** and **flow**. This feature is used in Primary Measuring Devices where the zero reference is at a higher level than the channel bottom, at the point of measure. Enter distance in **Measurement Units P104**.

P704 Maximum Head

Enter the **head** value that represents **maximum flow**, enter in **Measurement Units P104**.

Note any change to the value of this parameter will be reflected in P106 (Span) and vice versa.

P705 Maximum Flow

When **P702 = 2 Ratiometric** enter the **flow rate** value that occurs at **maximum head (P704)**, enter in **volume units (P706)** per **time units (P707)**.

When **P702 = 1 Absolute**, and all relevant flow parameters have been entered, the **maximum flow** that occurs **at maximum head P704** will be calculated, after the unit is returned to RUN mode, and displayed in this parameter in **volume units (P706)** per **time units (P707)**.

*This value can be edited to allow mA output range adjustments for A*V applications.

P706 Volume Units

Select the Volume Units to be used to display and calculate the flow rate from the options below:

OPTION	DESCRIPTION
1 = Litres (Default)	Flow will be calculated and displayed in Litres
2 = Cubic metres	Flow will be calculated and displayed in Metres³
3 = Cubic feet	Flow will be calculated and displayed in Feet³
4 = UK Gallons	Flow will be calculated and displayed in UK Galls.
5 = US Gallons	Flow will be calculated and displayed in US Galls.
6 = Mill. US Gallons	Flow will be calculated and displayed in Millions US Galls.

P707 Time Units

Select the Time Units to be used with the Volume Units to determine the desired flow rate from the options below:

OPTION	DESCRIPTION
1 = per Second	Flowrate will be calculated and displayed in Volume units/ Second
2 = per Minute	Flowrate will be calculated and displayed in Volume units/ Minute
3 = per Hour	Flowrate will be calculated and displayed in Volume units/ Hour
4 = per Day (Default)	Flowrate will be calculated and displayed in Volume units/ Day

P708 Flow Decimal

This parameter determines the number of decimal places in the flow rate reading during run mode. It can be set between 0 and 3. **Default = 2**

P709 Flow Cutoff

This parameter is used to select the minimum flow, in a % of flow rate, which is to be totalised. Enter values in % of maximum flow. **Default = 5%**

Dimensions

P710 Dimension A

This parameter is used to enter dimension "A" of the Primary Measuring Device, where applicable, **see dimensions table for further details.**

P711 Dimension B

This parameter is used to enter dimension "B" of the Primary Measuring Device, where applicable, **see dimensions table for further details.**

P712 Dimension C

This parameter is used to enter dimension "C" of the Primary Measuring Device, where applicable, **see dimensions table for further details.**

P713 Dimension D

This parameter is used to enter dimension "D" of the Primary Measuring Device, where applicable, **see dimensions table for further details.**

Dimensions table

PRIMARY MEASURING DEVICE	P710 Dim 'A'	P711 Dim 'B'	P712 Dim 'C'	P713 DIM 'B'
P700 = 1 Exponent P701 = 1 Supp. Rectangular Weir P702 = 1 Absolute	Crest Width	<i>Not Required</i>	<i>Not Required</i>	<i>Not Required</i>
P700 = 1 Exponent P701 = 2 Trapezoidal P702 = 1 Absolute	Crest Width	<i>Not Required</i>	<i>Not Required</i>	<i>Not Required</i>
P700 = 1 Exponent P701 = 5 Leopold Lagco Flume P702 = 1 Absolute	Throat Diameter	<i>Not Required</i>	<i>Not Required</i>	<i>Not Required</i>
P700 = 1 Exponent P701 = 6 V Notch P702 = 1 Absolute	V-Notch Angle	<i>Not Required</i>	<i>Not Required</i>	<i>Not Required</i>
P700 = 2 BS 3680 Flume P701 = 1 Rectangular	Approach Width	Throat Width	Throat Length	<i>Not Required</i>
P700 = 2 BS 3680 Flume P701 = 2 Rectangular with hump	Approach Width	Throat Width	Throat Length	Hump Height
P700 = 2 BS 3680 Flume P701 = 3 U-Throated	Approach Width	Throat Width	Throat Length	<i>Not Required</i>
P700 = 2 BS 3680 Flume P701 = 3 U-Throated with hump	Approach Width	Throat Width	Throat Length	Hump Height
P700 = 3 BS 3680 Weir P701 = 1 Rectangular	Approach Width	Crest Width	Crest Height	<i>Not Required</i>
P700 = 3 BS 3680 Weir P701 = 3 Rect. Broad crested	Approach Width	Crest Width	Crest Height	<i>Not Required</i>
P700 = 4 Area Velocity P701 = 1 Circular Straight	Base Diameter	<i>Not Required</i>	<i>Not Required</i>	<i>Not Required</i>
P700 = 4 Area Velocity P701 = 2 Rectangular	Channel Width	<i>Not Required</i>	<i>Not Required</i>	<i>Not Required</i>
P700 = 4 Area Velocity P701 = 3 Trapezoidal	Channel Width Top	Channel Width Bottom	Channel Depth	<i>Not Required</i>
P700 = 4 Area Velocity P701 = 4 Round Pipe	Inside Diameter	<i>Not Required</i>	<i>Not Required</i>	<i>Not Required</i>
P700 = 4 Area Velocity P701 = 5 Fixed Pipe	Inside Diameter	Fixed Head	<i>Not Required</i>	<i>Not Required</i>

PRIMARY MEASURING DEVICE	P710 Dim 'A'	P711 Dim 'B'	P712 Dim 'C'	P713 DIM 'B'
P700 = 1 Exponent P701 = 1 Supp. Rectangular Weir P702 = 1 Absolute	Crest Width	<i>Not Required</i>	<i>Not Required</i>	<i>Not Required</i>
P700 = 1 Exponent P701 = 2 Trapezoidal P702 = 1 Absolute	Crest Width	<i>Not Required</i>	<i>Not Required</i>	<i>Not Required</i>
P700 = 1 Exponent P701 = 5 Leopold Lagco Flume P702 = 1 Absolute	Throat Diameter	<i>Not Required</i>	<i>Not Required</i>	<i>Not Required</i>
P700 = 1 Exponent P701 = 6 V Notch P702 = 1 Absolute	V-Notch Angle	<i>Not Required</i>	<i>Not Required</i>	<i>Not Required</i>
P700 = 2 BS 3680 Flume P701 = 1 Rectangular	Approach Width	Throat Width	Throat Length	<i>Not Required</i>
P700 = 2 BS 3680 Flume P701 = 2 Rectangular with hump	Approach Width	Throat Width	Throat Length	Hump Height
P700 = 2 BS 3680 Flume P701 = 3 U-Throated	Approach Width	Throat Width	Throat Length	<i>Not Required</i>
P700 = 2 BS 3680 Flume P701 = 3 U-Throated with hump	Approach Width	Throat Width	Throat Length	Hump Height
P700 = 3 BS 3680 Weir P701 = 1 Rectangular	Approach Width	Crest Width	Crest Height	<i>Not Required</i>
P700 = 3 BS 3680 Weir P701 = 3 Rect. Broad crested	Approach Width	Crest Width	Crest Height	<i>Not Required</i>
P700 = 4 Area Velocity P701 = 1 Circular Straight	Base Diameter	<i>Not Required</i>	<i>Not Required</i>	<i>Not Required</i>
P700 = 4 Area Velocity P701 = 2 Rectangular	Channel Width	<i>Not Required</i>	<i>Not Required</i>	<i>Not Required</i>
P700 = 4 Area Velocity P701 = 3 Trapezoidal	Channel Width Top	Channel Width Bottom	Channel Depth	<i>Not Required</i>
P700 = 4 Area Velocity P701 = 4 Round Pipe	Inside Diameter	<i>Not Required</i>	<i>Not Required</i>	<i>Not Required</i>
P700 = 4 Area Velocity P701 = 5 Fixed Pipe	Inside Diameter	Fixed Head	<i>Not Required</i>	<i>Not Required</i>

PRIMARY MEASURING DEVICE	P710 Dim 'A'	P711 Dim 'B'	P712 Dim 'C'	P713 DIM 'B'
P700 = 5 Special	Flume	<i>Not</i>	<i>Not</i>	<i>Not</i>
P701 = 1 Palmer Bowlus	Size	<i>Required</i>	<i>Required</i>	<i>Required</i>
P700 = 5 Special	Flume	<i>Not</i>	<i>Not</i>	<i>Not</i>
P701 = 2 H-Flume	Size	<i>Required</i>	<i>Required</i>	<i>Required</i>
P700 = 5 Special	V-Notch	<i>Not</i>	<i>Not</i>	<i>Not</i>
P701 = 3 V-Notch Angle	Angle	<i>Required</i>	<i>Required</i>	<i>Required</i>

P714 Roughness Coefficient (Ks)

When P700 = 2, BS3680 Flume this parameter is used to enter the roughness coefficient of the flume in millimetres, **see table below for further details.**

Surface Classification	Value of Ks	
	Good Example mm	Normal Value mm
Plastics etc.		
Perspex, PVC or other smooth faced		0.003
Asbestos cement		0.015
Resin-bonded glass-fibre moulded against smooth forms of sheet metal or well sanded and painted timber	0.03	0.06
Metal		
Smooth, machined, and polished metal	0.003	0.006
Uncoated sheet metal, rust free	0.015	0.03
Painted metal	0.03	0.06
Galvanised metal	0.06	0.15
Painted or coated casting	0.06	0.15
Uncoated casting	0.15	0.3
Concrete		
In-situ or precast construction using steel formwork, with all irregularities rubbed down or filled in.	0.06	0.15
In-situ or precast construction using plywood or timber framework	0.3	0.6
Smooth troweled cement rendering	0.3	0.6
Concrete with thin film of sewage slime	0.6	1.5
Wood		
Planned timber or plywood	0.3	0.6
Well sanded and painted	0.03	0.06

P715 Water Temperature

When P700 = 2, BS3680 Flume this parameter is used to enter the mean water temperature in °C.

Calculations

The following parameters P720 to P725 are values calculated by the unit, dependent on application, and are "Read Only", therefore have no default values.

P720 Area

Displays the calculated value of the area when, P700 = 2 BS3690 flumes and P700 = 4 Area Velocity.

P721 Cv

Displays the calculated value for Cv when, P700 = 2 BS3680 flumes.

P722 Cd

Displays the calculated value for Cd when, P700 = 2 BS3680 flumes.

P723 Ce

Displays the calculated value for Ce when, P700 = 2 BS3680 weirs.

P724 Cu

Displays the calculated value for Cu when, P700 = 2 BS3680 flume and P701 = 3 or 4 U-Throated flumes.

P725 Kb

Displays the calculated value for Kb when, P700 = 3 BS3680 weirs and P701 = 1 Rectangular weir.

Device mode = Velocity

The calculation of flow using Velocity Area is only possible when the current input or velocity sensor is used to provide an input signal proportional to the velocity of the flow.

When P130 Device Mode = 0 Off or 1 Modbus, using current input

Parameters P726 to P729 are used to configure the optional 4 -20mA input for a velocity sensing device. When an **Area/Velocity** application is selected the unit will automatically allocate the 4-20mA input to a velocity input device and it is therefore not necessary to allocate **P101 Transducer = 0** (Auxiliary).

P726 Low mA In

This parameter sets the mA current input figure that is used to represent minimum velocity (P728) when the current input is allocated to a velocity input device. **Default = 4 mA**

P727 High mA In

This parameter sets the mA current input figure that is used to represent maximum velocity (P729) when the current input is allocated to a velocity input device. **Default = 20 mA**

P728 Low Velocity In

This parameter sets the minimum velocity, at low mA In (P726) when the current input is allocated to a velocity input device. **Default = 0 m/sec**

P729 High Velocity In

This parameter sets the maximum velocity, at high mA In (P727) when the current input is allocated to a velocity input device. **Default = 0.3 m/sec**

When P130 Device Mode = 2 Velocity, using Speedy or MicroFlow velocity sensor.

The velocity sensor cannot be accessed directly by the user and is therefore configured by changing specific parameters within the FlowCERT which will then be passed to the Velocity sensor via the digital communications interface. Parameters P680 to P695 are used to configure the "speedy" velocity sensor. Parameters P680, P683, P684, P687, P688 and P695 are used to configure the "MicroFlow" velocity sensor.

P680 Speedy Update Interval

This parameter sets the update or polling interval, in seconds, at which the FlowCERT will obtain an updated velocity reading from the velocity sensor. When set to zero no update is obtained from the sensor.

Default = 5 seconds

P681 Sound Velocity in Water

Sets the initial value for the velocity of sound in water, this value is only used when the Speedy is initialised and is used for the first few readings or if temperature values are not available from the sensor. The sound velocity is then dynamically updated within the Speedy dependant on temperature.

Default = 1450 m/s

P682 Minimum Flow Velocity

Sets the minimum value for flow velocity, below which, flow values will be ignored. **Default = 0 m/second**

P683 Maximum Flow Velocity

Sets the maximum value for flow velocity, above which, flow values will be ignored. **Default = 6 m/second**

P684 Damping Factor

Sets the value of damping applied to the sensor's velocity measurement.

Default = 5 seconds

Note: This parameter is ignored by the "MicroFlow" (its internal default = 24) until a different value is set. 0 = least damping, 28 = most damping.

P685 Peak Width

Sets the evaluation width in percentage, the Speedy locates the frequency at each histogram evaluation which contains the most edge measurements within a frequency window defined by the peak width.

For example, consider a frequency of 1000Hz, with a peak width of 20%, the speedy will consider all measurement values between 800Hz and 1200Hz.

Default = 20 %

P686 Minimum Signal Quality

Defines the minimum relationship between edges that have to be considered for calculation and edges to reject (e.g. due to being out of peak width). The measurement will not be processed in the damping buffer if it does not satisfy the minimum signal quality. **Default = 35%**

P687 Stability

Sets the time, in seconds, of how long the latest valid measurement will be held. **Default = 20s**

Note: This parameter controls the response of the "MicroFlow". Fast response = value lower than 12, Slow response = value greater than 12.

P688 Gain

Used to enter a fixed gain value in dB, this parameter is only used if the gain mode, P690, is set to manual and is intended mainly for test purposes. Pulsar recommends using automatic gain control for taking measurements.

Default = 30 dB

P689 Speedy Level

Sets the initial value for the head of water above the Speedy, this value is only used when the Speedy is initialised and is used for the first few readings. The level is then dynamically updated by the FlowCERT.

Default = 300 mm

P690 Automatic Gain Control

This parameter can be used to switch between automatic and fixed gain.

OPTION	DESCRIPTION
0 = No	Use manual fixed value – see P688 Gain
1 = Yes (Default)	Use automatic gain - recommended

P691 High Level Trigger

This parameter can be used to set the sensitivity of the “speedy” velocity sensor.

OPTION	DESCRIPTION
0 = No	Low – very susceptible to interference
1 = Yes (Default)	High – recommended trigger setting

P693 Min Speed

This parameter is only available when P700 = 7 AV Universal. The FlowCERT will switch to a 32-point curve if the velocity falls below the value set in this parameter, minus the value set in **P694**. The FlowCERT will revert to normal operation when the velocity reaches the value set in this parameter plus that set in **P694**. **Default = 0.00 m/s**

P694 Speedy Hysteresis

This parameter is only available when P700 = 7 AV Universal. This determines the value of the velocity window (in m/s), as well as that set in **P693**, to revert to a breakpoint curve fit, or return to normal flow operation. **Default = 0.00 m/s**

P695 Correction Factor

This parameter is used to enter a correction factor, when required for the velocity readings displayed on the unit. In percentage terms 1 is 100%, 0.5 would be 50 % and 2 would be 200 %. **Default = 1**

Breakpoints

P730 – P793 Breakpoints

Where the Primary Measuring device does not match any of the pre-programmed devices contained in the FlowCERT, then a universal volume calculation can be performed. A head Vs flow chart is used, to enter a number of **Breakpoints** for the **head** and **flow (P730-793)**, which is either provided by the manufacturer or created based on the dimensions of the device.

Breakpoints should be entered in **pairs of head** and the corresponding **flow** for that head. The **first pair** entered must be for **zero head** and **flow** and the **last pair** entered must be for **maximum head** and **flow**. The higher number of breakpoints (pairs) entered then the greater accuracy there will be. There are a maximum number of 32 breakpoints (pairs) for head and flow that can be entered.

Tables

P796 Reset Breakpoints

This parameter allows the resetting, to the default value, of all previously set breakpoints (P730-793), without having to access them individually. When it is necessary to reset or amend particular breakpoints this can be achieved by directly accessing the desired parameter (P730-793) and changing as required.

P797 Number of Breakpoints Set

This parameter allows you to review the number of breakpoints that have been set, without the need to access each individual one in turn, this is a "Read Only" parameter and no values can be entered.

Average Flow

P863 Average Flow

This parameter will display the Average Flow for the time period set in **Average Time (P864)**. It is read only and cannot be changed.

P864 Average Time

This parameter will set the time period over which the Average Flow (P863) is to be calculated before being displayed.

Display Parameters

Options

P800 Display Units

This parameter determines whether the reading displayed is in **Measurement Units (P104)**, or as a **percentage of span**.

OPTION	DESCRIPTION
1 = Measured (Default)	Display is in selected unit's dependent in Mode (P100)
2 = Percentage	Display is in percentage of span dependent in Mode (P100)

P801 Decimal Places

This parameter determines the number of decimal places on the reading during run mode.

Minimum = 0 (No decimal places), Maximum 3 = (3 decimal Places)

Default = 2 (2 decimal Places).

P802 Display Offset

The value of this parameter is added to the reading before it is displayed, in **Measurement Units (P104)**.

It does not affect the relay setpoints or the mA output, only the reading on the display.

You could use this feature if for example you wanted to reference the reading to sea level, where you would enter the distance between **Empty Level (P105)** and sea level. If the empty level point is below sea level, then enter a negative value.

P804 Display Conversion

The reading is multiplied by the value of this parameter before being displayed. The default is 1.0, but if for example you wanted to display the reading in yards, then set the **Measurement Units (P104)** to feet and set **P804** to 3.

Failsafe

P808 Failsafe Mode

By default, if a fail-safe condition occurs, then the display, relays and the mA output are held at their last **known** values until a valid reading is obtained.

If required, then you can change this so that the unit goes to **high** (100% of span), or **low** (empty) as follows:

OPTION	DESCRIPTION
1 = Known (Default)	Remain at its last known value
2 = High	Will fail to the high value (100% span)
3 = Low	Will fail to the low value (empty)

— See Also *P218, P228, P238, P248, P258 - Relay Fail-safe and P840 mA Output Fail-safe*

Important Notice

In the event of a fail-safe condition occurring, the display, relays and mA Output can be configured to fail to a condition which is independent of each other. To set independent Relay Failsafe see P218, 228, 238, 248, 258. And for independent mA Output Failsafe see P840.

P809 Failsafe Time

In the event of a failsafe condition the failsafe timer determines the time before failsafe mode is activated. **Default = 2mins**

If the timer activates, the unit goes into **failsafe**, as determined by **P808 (Display), P218, 228, 238 (Relays) and P840 (mA Output)**. When this happens, you will see the message “**Failed Safe!**” on the display, along with a message explaining why (lost echo or transducer fault, for example). When a valid measurement is obtained then the display, relays and mA output will be restored, and the timer is reset.

Auxiliary

P810 Units

This parameter determines whether the **Measurement units (P104)** are displayed on the auxiliary line of the display in run mode.

OPTION	DESCRIPTION
0 = No	Measurement units will not be displayed
1 = Yes (Default)	Measurement units will be displayed

P811 Alarm Messages

This parameter determines whether notification messages are displayed on the auxiliary line of the display in run mode when an alarm relay is switched on or off. The message is in the form “Alarm High ON”, where the ‘High’ is determined by the setting of the relay **Alarm ID (P212, 222, 232)**.

OPTION	DESCRIPTION
0 = No (Default)	Alarm messages will not be displayed
1 = Yes	Alarm messages will be displayed

P812 General Control or Pump Messages

This parameter determines whether notification messages are displayed on the auxiliary line of the display in run mode when a pump or general control relay is switched on or off. The message is in the form "General 1 ON", where the number displayed is the number of the relay.

OPTION	DESCRIPTION
0 = No (Default)	Pump messages will not be displayed
1 = Yes	Pump messages will be displayed

P813 Control Messages

This parameter determines whether notification messages are displayed on the auxiliary line of the display in run mode when a control relay is switched on or off. The message is in the form "Time ON".

OPTION	DESCRIPTION
1	Control messages will not be displayed
1 = Yes	Control messages will be displayed

P814 Miscellaneous Messages

This parameter determines whether notification messages are displayed on the auxiliary line of the display in run mode when a miscellaneous relay is switched on or off. The message is in the form "Clock ON".

OPTION	DESCRIPTION
0 = No (Default)	Miscellaneous messages will not be displayed
1 = Yes	Miscellaneous messages will be displayed

P815 Auxiliary Source

This parameter determines whether the instantaneous velocity readings are displayed on the auxiliary line of the display in run mode.

OPTION	DESCRIPTION
0 = Off (Default)	Auxiliary display not used to display measurement readings.
1 = Velocity	Instantaneous velocity measurement will be displayed

P816 Totaliser (R)

This parameter determines whether or not the resettable totaliser will be displayed in the auxiliary line of the display in run mode. When selected the auxiliary display will scroll between the resettable totaliser and the totaliser units selected. **Default = 0 (Off).**

The resettable totaliser can be reset whilst in run mode via the "Totaliser" hot key  by pressing "0" whilst Total (R) is displayed.

Totaliser

P820 Totaliser

Displays the current value of the, non-resettable totaliser. During run mode this totaliser can be viewed via the "Totaliser" hot key, . Unlike the resettable totaliser this totaliser cannot be reset whilst in run mode, it can however be reset whilst in program mode by accessing **P820 Totaliser** and entering **zero**.

P821 Totaliser (R)

Displays the current value of the, resettable totaliser. This **totaliser** can be allocated to appear, during **run mode**, on the auxiliary display line (**P816**) or alternatively via the "Totaliser" hot key.

P822 Totaliser Decimal Places

This parameter determines the number of decimal places in the totaliser during run mode. It can be set between 1 and 3. **Default = 2**

P823 Totaliser Multiplication Factor

This parameter determines the number of decimal places in the totaliser during run mode. It can be set between 1 and 3. **Default = 2**

Use this parameter if the totaliser increments by too large or small amount, enter the factor by which the actual flow rate is multiplied by before incrementing the totaliser.

Example: If flowrate is being calculated and displayed in ltrs/second and it is desired to increment the totaliser in cubic metres select 7 = *1000.

When viewing, the totaliser display will state, "Units are: L*1000", and the totaliser will be incremented every 1000 litres. The options are:

OPTION	DESCRIPTION
1 = 1/1000	Totaliser will increment every 1/1000 th units of flow
2 = 1/100	Totaliser will increment every 1/100 th units of flow
3 = 1/10	Totaliser will increment every 1/10 th units of flow
4 = *1 (Default)	Totaliser will increment every 1 units of flow
5 = 10	Totaliser will increment every 10 units of flow
6 = 100	Totaliser will increment every 100 units of flow
7 = 1,000	Totaliser will increment every 1000 units of flow
8 = 10,000	Totaliser will increment every 10,000 units of flow
9 = 100,000	Totaliser will increment every 100,000 units of flow
10 = 1,000,000	Totaliser will increment every 1,000,000 units of flow

P824 Totaliser Enable

This parameter determines if the totaliser is enabled or not, the options are as follows:

OPTION	DESCRIPTION
0 = Off	Totaliser will be disabled
1 = On (Default)	Totaliser will be enabled

Bargraph

P829 Bargraph

By default, the Bargraph will be representative of the reading obtained, as determined by the **Mode P100**.

The options, dependant on the **value** entered for **Mode P100**, are as follows:

OPTION	DESCRIPTION
1 = Level	Bargraph will be representative of Level
2 = Head (Default)	Bargraph will be representative of Head
3 = Flow	Bargraph will be representative of Flow

mA Output 1 Parameters

Range

P830 mA 1 Range

This parameter determines the range of the mA output, from the following:

OPTION	DESCRIPTION
0 = Off	mA output disabled
1 = 0 to 20 mA	mA output directly proportional to the mA mode (P831) , so if the reading is 0% the output is 0 mA. If the reading is 100% the output is 20 mA.
2 = 4to 20 mA (Default)	mA output directly proportional to the mA mode (P831) , so if the reading is 0% the output is 4 mA. If the reading is 100% the output is 20 mA.
3 = 20 to 0 mA	mA output inversely proportional to the mA mode (P831) , so if the reading is 0% the output is 20 mA. If the reading is 100% the output is 0 mA.
4 = 20 to 4 mA	mA output inversely proportional to the mA mode (P831) , so if the reading is 0% the output is 20 mA. If the reading is 100% the output is 4 mA.

Operation

P831 mA 1 Mode

This parameter determines how the mA Output relates to what is measured. By **default**, it operates exactly the same as the display (**P100**), but it can be set to operate as follows:

OPTION	DESCRIPTION
0 = Default	mA output relative to Mode P100
1 = Distance	mA output relative to Distance .
2 = Level	mA output relative to Level .
3 = Space	mA output is relative to space .
4 = OCM Head	mA output relative to OCM Head
5 = OCM Flow	mA output is relative to OCM flow .
6 = Average Flow	mA output is relative to Average flow
7 = Velocity	mA output is relative to Velocity (only available when a velocity sensor is used).

Setpoint

By **default**, the mA Output will represent the **empty (0 or 4mA)** dependant on (**P830 mA Range**) and **100%** of the operational **span (20mA)**, but you may wish to have the output represent a section of the operational span. For example, the application has an operational span of 6 metres, but **output** is to **represent empty (0 or 4mA)** dependant on (**P830 mA Range**) to a **level of 5 metres (20mA)**. If so P834 (Low Level) should be set to 0.00 metres and P835 (High Level) should be set to 5 metres.

P834 mA 1 Low Level

This parameter sets the level, distance, or space, depending on the selected **mA Out Mode (P831)** at which the low mA output will occur (**0 or 4mA** dependant on (**P830 mA Range**)). **Default = 0.00 m**

*For AV applications, the output is scaled for flow by editing the **P705** value.

P835 mA 1 High Level

This parameter sets the level, distance or space, depending on the selected **mA Out Mode (P831)** at which the high mA output will occur (**20mA**).

Default = 6.00 m

*For AV applications, the output is scaled for flow by editing the **P705** value.

Limits

P836 mA 1 Low Limit

This parameter sets the lowest level that the mA output will drop to, the default is 0mA, but you can override this if the device you connect to cannot for example accept less than 2mA, yet you want to use the 0-20mA range.

Default = 0.00mA

P837 mA 1 High Limit

This parameter sets the highest level that the mA output will rise to, the default is 20 mA, but you can override this if the device you connect to cannot for example accept more than 18 mA, yet you want to use the 0-20 mA range. **Default = 20.00mA**

Trim

P838 mA 1 Low Trim

If the device you are connected to is not calibrated, and not showing the correct **low value** (reading), then you can trim it using this parameter. You can either type in the offset directly or use the arrow keys to move the output up and down until you get the expected result (reading) on the device that is connected.

P839 mA 1 High Trim

If the device you are connected to is not calibrated, and not showing the correct **high value** (reading), then you can trim it using this parameter. You can either type in the offset directly or use the arrow keys to move the output up and down until you get the expected result (reading) on the device that is connected.

Failsafe

P840 mA 1 Failsafe Mode

This parameter determines what happens to the mA output in the event of the unit going into fail-safe mode. The **default** is to do the same as the **system fail-safe (P808)**, but this can be overridden to force the mA output to an independent fail-safe mode as follows:

OPTION	DESCRIPTION
0 = Default	mA output will fail as per P808
1 = Hold	mA output will retain its last known value.
2 = Low	mA output will fail to its low condition.
3 = High	mA output will fail to its high condition.

Allocation

P841 mA 1 Allocation

By default, the mA output will be representative of the reading obtained, as determined by the **Mode P100**. This parameter is automatically set to the correct default option when selecting the **Mode P100** and **Xducer (P101)**, and under normal circumstances will not require changing.

The options, dependant on the **value** entered for **Mode P100**, are as follows:

OPTION	DESCRIPTION
1 = Auxiliary	mA output relates to Aux Input
2 = Xducer 1 (Default)	mA output relates to Xducer 1 level .

mA Output 2 Parameters

Range

P890 mA 2 Range

This parameter determines the range of the mA output, from the following:

OPTION	DESCRIPTION
0 = Off	mA output disabled
1 = 0 to 20 mA	mA output directly proportional to the mA mode (P891) , so if the reading is 0% the output is 0 mA. If the reading is 100% the output is 20 mA.
2 = 4to 20 mA (Default)	mA output directly proportional to the mA mode (P891) , so if the reading is 0% the output is 4 mA. If the reading is 100% the output is 20 mA.
3 = 20 to 0 mA	mA output inversely proportional to the mA mode (P891) , so if the reading is 0% the output is 20 mA. If the reading is 100% the output is 0 mA.
4 = 20 to 4 mA	mA output inversely proportional to the mA mode (P891) , so if the reading is 0% the output is 20 mA. If the reading is 100% the output is 4 mA.

Operation

P891 mA 2 Mode

This parameter determines how the mA Output relates to what is measured. By **default**, it operates exactly the same as the display (**P100**), but it can be set to operate as follows:

OPTION	DESCRIPTION
0 = Default	mA output relative to Mode P100
1 = Distance	mA output relative to Distance .
2 = Level	mA output relative to Level .
3 = Space	mA output is relative to space .
4 = OCM Head	mA output relative to OCM Head
5 = OCM Flow	mA output is relative to OCM flow .
6 = Average Flow	mA output is relative to Average flow
7 = Velocity	mA output is relative to Velocity (only available when a velocity sensor is used).

Setpoint

By **default**, the mA Output will represent the **empty (0 or 4mA)** dependant on (**P890 mA Range**) and **100%** of the operational **span (20mA)**, but you may wish to have the output represent a section of the operational span. For example, the application has an operational span of 6 metres, but **output** is to **represent empty (0 or 4mA)** dependant on (**P890 mA Range**) to a **level of 5 metres (20mA)**. If so P894 (Low Level) should be set to 0.00 metres and P895 (High Level) should be set to 5 metres.

P892 mA 2 Low Level

This parameter sets the level, distance, or space, depending on the selected **mA Out Mode (P891)** at which the low mA output will occur (**0 or 4mA** dependant on (**P890 mA Range**)). **Default = 0.00 m**

*For AV applications, the output is scaled for flow by editing the **P705** value.

P893 mA 2 High Level

This parameter sets the level, distance or space, depending on the selected **mA Out Mode (P891)** at which the high mA output will occur (**20mA**).

Default = 6.00 m

*For AV applications, the output is scaled for flow by editing the **P705** value.

Limits

P894 mA 2 Low Limit

This parameter sets the lowest level that the mA output will drop to, the default is 0mA, but you can override this if the device you connect to cannot for example accept less than 2mA, yet you want to use the 0-20mA range.

Default = 0.00mA

P895 mA 2 High Limit

This parameter sets the highest level that the mA output will rise to, the default is 20 mA, but you can override this if the device you connect to cannot for example accept more than 18 mA, yet you want to use the 0-20 mA range. **Default = 20.00mA**

Trim

P896 mA 2 Low Trim

If the device you are connected to is not calibrated, and not showing the correct **low value** (reading), then you can trim it using this parameter. You can either type in the offset directly or use the arrow keys to move the output up and down until you get the expected result (reading) on the device that is connected.

P897 mA 2 High Trim

If the device you are connected to is not calibrated, and not showing the correct **high value** (reading), then you can trim it using this parameter. You can either type in the offset directly or use the arrow keys to move the output up and down until you get the expected result (reading) on the device that is connected.

Failsafe

P898 mA 2 Failsafe Mode

This parameter determines what happens to the mA output in the event of the unit going into fail-safe mode. The **default** is to do the same as the **system fail-safe (P808)**, but this can be overridden to force the mA output to an independent fail-safe mode as follows:

OPTION	DESCRIPTION
0 = Default	mA output will fail as per P808
1 = Hold	mA output will retain its last known value.
2 = Low	mA output will fail to its low condition.
3 = High	mA output will fail to its high condition.

Allocation

P899 mA 2 Allocation

By default, the mA output will be representative of the reading obtained, as determined by the **Mode P100**. This parameter is automatically set to the correct default option when selecting the **Mode P100** and **Xducer (P101)**, and under normal circumstances will not require changing.

The options, dependant on the **value** entered for **Mode P100**, are as follows:

OPTION	DESCRIPTION
1 = Auxiliary	mA output relates to Aux Input
2 = Xducer 1 (Default)	mA output relates to Xducer 1 level .

Compensation Parameters

Offset

P851 Measurement Offset

The value of this parameter is added to the measured distance, in **Measurement Units (P104)**.

This Offset will be added to the level, as derived from the transducer, and will affect everything including the reading on the display, the relay setpoints and the mA output.

Temperature

P852 Temperature Source

This parameter determines the source of the temperature measurement. By **default**, it is set to automatic (**P852=1**), which will automatically detect if a temperature sensor is available from the transducer. If for any reason, no temperature input is received, then the **Fixed Temp** value is used, as set by **P854**.

The temperature source can be specifically set as follows:

OPTION	DESCRIPTION
1 = Automatic (Default)	Will automatically select transducer temperature sensor, if available, or fixed temperature (P854) if no temperature sensor found.
2 = Xducer	Always uses temperature reading from transducer.
3 = Fixed	Always uses fixed temperature (P854)

P852 Temperature Source

This parameter sets the temperature, in degrees centigrade to be used if **P852 (Temperature Source) =3. Default = 20°C.**

Velocity

P860 Sound Velocity

This parameter allows for the velocity of sound to be changed according to the atmosphere the transducer is operating in. By default, the velocity is set for sound travelling in air at an ambient temperature of 20 degrees centigrade (at 1bar, atmospheric pressure). **Default = 342.72 m/sec.**

Stability Parameters

Damping

Damping is used to damp the display, to enable it to keep up with the process but ignore minor surface fluctuations.

P870 Fill Damping

This parameter determines the **maximum rate** at which the unit will respond to an **increase in level**. It should be set slightly higher than the maximum vessel fill rate. **Default = 10m/min.**

P871 Empty Damping

This parameter determines the **maximum rate** at which the unit will respond to a **decrease in level**. It should be set slightly higher than the maximum vessel empty rate. **Default = 10m/min.**

Indicator

P872 Fill Indicator

This parameter determines the rate at which the LCD **fill** indicator activates. **Default = 10m/min.**

P873 Empty Indicator

This parameter determines the rate at which the LCD **empty** indicator activates. **10m/min.**

Rate

P874 Rate Update

This parameter determines the way in which the rate is calculated. If set to **continuous (P874=0)**, then the rate is calculated and displayed continuously, i.e. any change seen from shot to shot is calculated and displayed, but if set to use **values P874=1(Default)** then the **values** set in **P875** and **P876** are used to calculate and display the rate.

P875 Rate Time

This parameter is the period (in seconds) over which the material level rate of change is averaged before the **Rate Value (P877)** is updated. If the **Rate Distance (P876)** is exceeded before the **Rate Time (P875)** has expired, then the **Rate Value (P877)** will be updated immediately. **Default = 60sec.**

P876 Rate Distance

This parameter is the rate **Measurement Units (P104)** over which the material level must change before the **Rate Value (P877)** is updated. If the **Rate Time (P875)** expires before the **Rate Distance (P876)** is exceeded, then the **Rate Value (P877)** will be updated immediately. **Default = 0.05m**

P877 Rate Value

This parameter displays the current rate of change of material level, in **Measurement Units (P104)** per minute. It is read only.

P878 Lower Cutoff

This parameter is used to select the minimum Rate to be calculated and can be used to eliminate unwanted updates from effects of ripples/waves on the surface of the material.

Filters

The following three parameters can be used to filter out unwanted changes of level caused by a 'rippled' or agitated surface.

P880 Gate Mode

This parameter determines the operation of the gate, which is established around the processed echo and is used to track the echoes movement and update the display. If set to **Fixed**, P880 = 0 (**Default**) then the width of the gate is determined by the value of **P881 Fixed Distance**. When set to **Calculated**, P880=1 then the gate width is automatically calculated and **updated** according to the values of **P870, P871, P874, P875 and P876**. Please consult Pulsar for further information and assistance on changing the value of this parameter.

P881 Fixed Distance

This parameter determines the width of gate to be used in tracking an echo and under normal circumstances will not require changing, but it can be increased in the cases where the surface is moving extremely fast (in excess of 10m/min) to ensure smooth processing of the changing level.

P882 Process Filter

This parameter determines the number of 'cycles' that will be taken before a change in level is processed and the display updated.

OPTION	DESCRIPTION
1 = Fast	level will be updated every cycle
2 = Medium	level will be updated every 8 cycles
3 = Slow (Default)	level will be updated every 16 cycles

P882 Process Filter

This parameter is used if you choose a solids application, **P102 Material = 2 (Solids)**, where there maybe angles of repose on the material, and can be used to determine where in the returned echo the displayed level is.
Default = 50%

Echo Processing Parameters

Transducer 1 Status

P900 Transducer 1 Status

This parameter shows the current state of the transducer. The value means the following:

OPTION	DESCRIPTION
0= OK	Transducer working correctly.
1= Disabled	Transducer is not being used (mA input is being used instead, so P101=1)
2= Stuck High	Indicates that the power and signal lines on the transducer terminals are crossed over, or the signal line is shorted to earth.
3= Not Found	No transducer is detected.

P901 Echo Confidence 1

This parameter displays the most recent echo confidence from the transducer. It is useful to help find the best mounting location for the transducer, where you should aim to get the highest figure. It is a percentage of confidence that the echo reporting the level is the correct one.

P902 Echo Strength 1

This parameter displays the most recent echo strength figure for the transducer, where a higher figure indicates a better returned echo.

P903 Average Noise 1

This is the mean noise reading for the transducer. It is measured while the transducer is not firing and gives an indication of the average amount of electrical noise present on the cabling.

P904 Peak Noise 1

This is the peak noise reading for the transducer. It is measured while the transducer is not firing and gives an indication of the maximum amount of electrical noise present on the cabling.

System Parameters

Passcode

P921 Enable Code

Enables the passcode (**P922**), which means the passcode must be entered to go into program mode. If **disabled** (set to **0**), then no passcode is required, and ENTER is used to enter program mode. **Default = 1 (Enabled)**

P922 Passcode

This is the passcode that must be used to enter program mode. The **default** is **1997**, but this can be changed to another value from 0 to 9999.

Backup

P925 Parameter Backup & Restore

This parameter is used to make a backup of all parameters, for example to ensure a default set is maintained within the unit. If alterations are made to the parameters that do not work as intended, then the backup set can be restored into the unit.

You can make two separate backup copies if you wish, called backup 1 and backup 2, and restore from either. The options are:

OPTION	DESCRIPTION
1= Backup 1	Make backup to area 1 of all parameters
2= Backup 2	Make backup to area 2 of all parameters
3= Restore 1	Restore all parameters from area 1
4= Restore 2	Restore all parameters from area 2

System Information

The following three parameters do not affect how the unit performs, but details, contained in them, may be required, by Pulsar, when making technical enquiries.

P926 Software Revision

This parameter will display the current software revision. It is read only and cannot be changed.

P927 Hardware Revision

This parameter will display the current hardware revision. It is read only and cannot be changed.

P928 Serial Number

This parameter will display the serial number of the unit. It is read only and cannot be changed.

P929 Site Identification

This parameter allows you to give each unit an individual reference number, for identification purposes. You can set any number between 1 and 99999.

P930 Factory Defaults

This parameter resets all parameter values to the original Factory Set values that were installed when the unit was tested before despatch to you.

To reset parameters, enter 1 (Yes), and press ENTER, then you will see a message "Entr if sure", you should press ENTER again. If you press any other key at this point, the parameters will not be reset, and you will see a message confirming this.

Once you have done this, program the unit, to the desired application.

Date & Time

The date and time is used, to control specific relay functions and date stamp certain events that are contained in the Data Logs. It is also used in conjunction with the system watchdog that keeps an eye on the times the unit has started.

P931 Date

This parameter displays the **current date**, in the format as set by **P933 (Date Format)** and can be reset if required.

P932 Time

This parameter displays the **current time** and can be reset if required, in the format HH: MM (24-hour format). This is set initially at the factory for UK time.

P933 Date Format

This parameter allows you to alter the format that the date is displayed to your choice of DD: MM: YY, MM: DD: YY or YY: MM: DD. The default is DD: MM: YY.

LED Colour

Each relay has an associated LED, located on the unit's front panel, which indicates the status of the relay. By default, the LED of any relay that has been programmed but is in its "OFF" state will be illuminated 'yellow'. When "ON" **alarm** relays will cause the **LED** to illuminate **Red** and **pump, control** and **miscellaneous** relays will cause the **LED** to illuminate **green**. LED's of any relays that have not been programmed will not be illuminated. Customised settings for the colour of LED's can be achieved by using the following parameters.

P935 Off Relay Colour

This parameter selects the colour that a **programmed relay** should be when it is in its "OFF" state. The **default** is **3 = yellow**, but can be changed to 'no colour', red or green.

P936 Alarm Relay Colour

This parameter selects the colour that an **alarm** relay should be when it is in its "ON" state. The **default** is **1 = red**, but can be changed to 'no colour', green or yellow.

P937 Pump Relay Colour

This parameter selects the colour that a **pump** relay should be when it is in its "ON" state. The **default** is **2 = green**, but can be changed to 'no colour', red or yellow.

P938 Control Relay Colour

This parameter selects the colour that a **control** relay should be when it is in its "ON" state. The **default** is **2 = green**, but can be changed to 'no colour', red or yellow.

P939 Miscellaneous Relay Colour

This parameter selects the colour that a **miscellaneous** relay should be when it is in its "ON" state. The **default** is **2 = green**, but can be changed to 'no colour', red or yellow.

All relays that are not programmed will show, 'no colour', i.e. they are off.

Watchdog

You can check how many times the unit has been switched on and look at the date and time of the last ten starts. This can be useful if there have been power failures or if for any reason the FlowCERT restarts due to a fault condition. The FlowCERT can be backed up from a battery which automatically cuts in during power failure, battery backed up units will continue uninterrupted operation and therefore will not register a loss of mains power. If, however the battery was to fail during a mains power interruption, a start-up would be recorded once power has been restored.

The following parameters can be accessed by directly entering the parameter number. To do this, enter the **program mode** and then **type** in the appropriate **parameter number**.

P940 Number of Starts

This parameter shows how many times the unit has been powered up.

P941-P960 Start Date & Time

Parameters **P941** and **P942** show the **date** and **time** that the unit was last started. There are **ten start dates & times** recorded, which are parameters **P943-P960**. The first on the list are the most recent, and the last ones are the oldest. These are read only and cannot be changed.

Important Notice

In order to ensure the correct operation of Daylight Saving Time P932 Time should be checked, and adjusted if necessary, to ensure that it is set for the current valid time.

Daylight Saving Time

P970 DST Enable

When **Enabled** (set to **1**) the internal clock will be automatically adjusted to compensate for the difference between standard time and **Daylight-Saving Time**. **Default = 1 (Yes)**

P971 DST Difference

This parameter sets the time difference between standard time and **Daylight-Saving Time**. The time difference is entered in HH:MM. **Default = 01:00**

P972 DST Start Time

This parameter is used to set the **time** of day at which **Daylight-Saving Time** will **start**, the time is entered in the format HH: MM (24-hour format). **Default = 02:00**

P973 Start Day

Use this parameter to enter the **day** of the week (**P974**) that **Daylight Saving Time** is to **start**.

OPTION	DESCRIPTION
2= Monday	DST will start on a Monday
3= Tuesday	DST will start on a Tuesday
4= Wednesday	DST will start on a Wednesday
5= Thursday	DST will start on a Thursday
6= Friday	DST will start on a Friday
7= Saturday	DST will start on a Saturday
8= Sunday (Default)	DST will start on a Sunday

P974 Start Week

This parameter will determine the **week** of the month (**P975**) in which **Daylight-Saving Time** is to **start**.

OPTION	DESCRIPTION
1= Week 1	DST will start on day (P973) in the first week (P974) of the month (P975) .
2= Week 2	DST will start on day (P973) in the second week (P974) of the month (P975) .
3= Week 3	DST will start on day (P973) in the third week (P974) of the month (P975) .
4= Week 4	DST will start on day (P973) in the fourth week (P974) of the month (P975) .
5= Last (Default)	DST will start on day (P973) in the last week (P974) of the month (P975) .

P975 Start Month

This parameter is used to select the **month**, in which **Daylight-Saving Time** will **start**.

OPTION	DESCRIPTION
1= January	DST will start during the month of January
2= February	DST will start during the month of February
3= March (Default)	DST will start during the month of March
4= April	DST will start during the month of April
5= May	DST will start during the month of May
6= June	DST will start during the month of June
7= July	DST will start during the month of July
8= August	DST will start during the month of August
9= September	DST will start during the month of September
10= October	DST will start during the month of October
11= November	DST will start during the month of November
12= December	DST will start during the month of December

P976 DST End Time

This parameter is used to set the **time** of day at which **Daylight-Saving Time** will **end**, the time is entered in the format HH: MM (24-hour format).
Default = 02:00.

P977 DST End Day

Use this parameter to enter the **day** of the week (**P974**) that **Daylight Saving Time** is to **end**.

OPTION	DESCRIPTION
2= Monday	DST will end on a Monday
3= Tuesday	DST will end on a Tuesday
4= Wednesday	DST will end on a Wednesday
5= Thursday	DST will end on a Thursday
6= Friday	DST will end on a Friday
7= Saturday	DST will end on a Saturday
8 = Sunday (Default)	DST will end on a Sunday

P978 End Week

This parameter will determine the **week** of the month (**P975**) in which **Daylight-Saving Time** is to end.

OPTION	DESCRIPTION
1= Week 1	DST will end on day (P973) in the first week (P974) of the month (P975) .
2= Week 2	DST will end on day (P973) in the second week (P974) of the month (P975) .
3= Week 3	DST will end on day (P973) in the third week (P974) of the month (P975) .
4= Week 4	DST will end on day (P973) in the fourth week (P974) of the month (P975) .
5= Last (Default)	DST will end on day (P973) in the last week (P974) of the month (P975) .

P979 End Month

This parameter is used to select the **month**, in which **Daylight-Saving Time** will **end**.

OPTION	DESCRIPTION
1= January	DST will end during the month of January
2= February	DST will end during the month of February
3= March	DST will end during the month of March
4= April	DST will end during the month of April
5= May	DST will end during the month of May
6= June	DST will end during the month of June
7= July	DST will end during the month of July
8= August	DST will end during the month of August
9= September	DST will end during the month of September
10= October (Default)	DST will end during the month of October
11= November	DST will end during the month of November
12= December	DST will end during the month of December

*Device Comm.**RS232 Set Up**P061 Comms Baud*

This parameter is used to set the speed (Baud Rate) of the RS232 communications and can be changed to suit the connecting device.

Default = 19200

RS 485 Set Up

For Profibus (optional), please refer to the RS485 communications manual.

P130 Device Mode

This parameter determines the mode of operations for a standard FlowCERT with Modbus/Velocity sensor capability.

OPTION	DESCRIPTION
0 = Off (Default)	RS485 communication is disabled.
1 = Modbus	RS485 communication is used for Modbus. Please refer to the RS485 communications manual for functionality.
2 = Velocity	RS485 communication is used for a MicroFlow or Speedy velocity sensor. This will enable the use of a velocity sensor for Area/Velocity flow calculations. This option disables the current input for use with a 4-20mA velocity sensor.

P133 Comms Baud

This parameter is used to set the speed (Baud Rate) of the RS485 digital communications interface for the velocity sensor and can be changed to suit the "speedy" model used.

Default = 9600

For further information on comms parameters and connections, please refer to Pulsar’s Communications manual.

Remote Alarm

When a Modem is connected, via the RS232 port, (Consult Pulsar or your local distributor for further details), the following parameters are used to set up the FlowCERT so that when the level reaches a specific alarm point, as determined by the setting of the relay(s) the unit will dial and connect to a remote telephone number to provide details of the event.

P144 Call Type

This parameter determines what type of connection is made via the modem.

OPTION	DESCRIPTION
0 = Off (Default)	Remote alarm function is disabled
1 = Ring	This option initiates a connection to a remote modem/computer which will then allow remote communication with the unit. Please consult Pulsar or your local distributor for further details.
2 = SMS	This option initiates a predetermined message which is sent to the remote telephone number detailing date and time the alarm was initiated, the site ID, alarm condition and level at the time the alarm was initiated.

P145 Tel. No.1

This parameter is used to enter the number of '0's that appear at the beginning of the telephone number to be dialled to receive the message.

OPTION	DESCRIPTION
0= None	No '0's present at the beginning of the telephone number to be dialled.
1 = Add 0 (Default)	1 '0' present at the beginning of the telephone number to be dialled.
2= Add 00	2 '0's present at the beginning of the telephone number to be dialled.

P146 Tel. No2

This parameter is used to enter the next 6 digits, following the '0's, of the telephone number to be dialled. If there are less than 6 digits following the '0's, then just enter the digits required, if there are more than 6 digits following the '0's then enter the first 6 digits and then proceed to P147 to enter the remainder.

P147 Tel. No3

This parameter is used to enter any remaining digits of the telephone number to be dialled after completion of P145 and P146 above.

Example

Telephone number to be dialled is: 0 1234 123456

P145 Tel. No. 1 = 1 (One '0' at the beginning of the telephone number)

P146 Tel. No. 2 = 123412 (The next 6 digits following the '0's).

P147 Tel. No. 3 = 3456 (Remaining digits of telephone number).

P148 Timed Out

This parameter will set the time period that the unit will wait for a reply before disconnecting.

Default = 90 seconds

P149 Retry No.

This parameter will set the number of times the telephone number will be re-dialled if no reply is received. If set to '0' then the number will be re-dialled continually until a reply is received, if set to '-1' then the number will not be re-dialled at all. Any other value entered between 1 and 99 will determine the number of re-dials to be attempted.

Default = 0

Test Parameters

Simulation

P980 Simulate

Test mode is used to simulate the application and confirm that all parameters and relay setpoints have been entered as expected. During simulation, there is a choice of whether the relays will change state (hard simulation) or not (soft simulation), but the LED's will always change colour as programmed, and the current output will change. If you want to test the logic of the system that the relays are connected to then select a hard simulation, but if you do not want to change the relay state, then select a soft simulation.

There are two simulation modes, **automatic** and **manual**. Automatic simulation will move the level up and down between empty level or the pre-determined **Start Level (P983)** and Pump/Control relay switch points, if you wish to change the direction of the level movement e.g. to go beyond relay setpoints, this can be done by using the arrow keys. In manual simulation, using the arrow keys will allow you to move the level up and down as required.

The choices for you to enter are as follows.

- 1= Manual soft simulation
- 2= Automatic soft simulation
- 3= Manual hard simulation
- 4= Automatic hard simulation

To return to program mode, press 'CANCEL' and test mode will end.

Important Notice

Pump start delay (which by default is 10 seconds) is set to 0 during simulation.

P981 Increment

By **default**, simulation mode will move by **0.1m** steps in manual simulation and by **0.1m/min** in automatic simulation. Altering the increment can change this value.

P982 Rate

In automatic mode, the rate at which the level will move up and down, is determined by distance, **P981 Increment** and the time, **P982 Rate** which by **default** is set to **1min** and can be changed as required. To increase the rate at which the level moves increase the **Increment (P981)** or decrease the **Rate (P982)**. To decrease the rate at which the level moves decrease the **Increment (P981)** or increase the **Rate (P982)**.

P983 Start Level

When using automatic simulation this parameter can be used to pre-determine the point at which the simulated level will start at and return to. This can be used to simulate the lowest point to which the level would normally operate.

P984 Inc. Change

When using automatic simulation, you can incrementally increase or decrease the rate whilst running simulation. The rate is increased /decreased incrementally by the value **P984 (Incremental Change)** by using the "**decimal point**" key to **increase** and the "**plus/minus**" key to **decrease** the rate of change.

Default = 0.1m

Hardware

P990 Self Test

If you enter 1 for this parameter, then the unit will perform a self-test. This will confirm that the various parts of the circuitry are working correctly. You will see confirmation messages that the clock and the EEPROM are working correctly, and error messages for any parts that fail.

P991 Hard Test

When this parameter is selected, the unit will test the following in turn.

- **LED's.** Watch them change colour as shown on the display, and press, ENTER, if they operated as shown.
- **Relays.** Press a numeric key corresponding to the number of the relay you wish to test, and the relay will change state each time the key is pressed. If you press any other key, other than a valid relay number, then the test will end.
- **Segments.** All the segments on the LCD are lit up, so you can see if they all work. Press, ENTER, to end the test. The LED's all go green at the same time.
- **Keys.** You should press each key, to confirm it works, with a counter showing how many more keys you have to press. Be sure to press the **CANCEL** key last, as this will show if all keys were pressed or not. If they were not, then an error message is displayed.

P992 mA Out Test

This parameter will allow you to force a specified current on the mA output, to test the equipment that it is connected to, and to make sure the unit is working correctly. The figure you enter will be generated by the mA output.

P993 mA In Test

This parameter will allow you to test the mA input, by injecting a known mA signal from an external source you can check the unit is working correctly and as expected.

P994 Transducer Test

If you enter 1 for this parameter it will continually fire the transducer, so you can check the wiring, until you press any key to cancel.

P995 Keys Test

You should press each key, to confirm it works, with a counter showing how many more keys you have to press. Press the **CANCEL** key last, as this will confirm if all keys were pressed or not. If they were not, then an error message is displayed.

P996 Relay Test

Press a numeric key corresponding to the number of the relay you wish to test, and the relay will change state each time the key is pressed. If you press any other key, other than a valid relay number, then the test will end.

CHAPTER 9 TROUBLESHOOTING

This section describes many common symptoms, with suggestions as to what to do. If the issue persists, please contact your local Pulsar distributor.

SYMPTOM	WHAT TO DO
Display blank, transducer not firing.	Check power supply, voltage selector switch and fuse.
Displays "No Xducer"	Check wiring to transducer.
Displays "Xducer Flt"	There is a fault with the transducer wiring, so check wiring to transducer.
Displays 'Failed Safe'	The transducer has not been able to lock on to a target. Check transducer wiring, check P900 status. Check to see if transducer is 'clicking', check for any obstructions in the application.
Incorrect reading being displayed for current level.	Measure actual distance from transducer head to surface of material. Enter Program Mode and directly access P21 (Set Distance) type in the measured distance, ENTER, ENTER again when prompted, wait until SET displayed and return to Run Mode, display should now update to correct reading.
Material level is consistently incorrect by the same amount.	Check empty level, (P105) display offset, (P802) and measurement offset (P851).
LED's change colour at relevant relay switch points but relays do not change state.	Check supply to unit and ensure voltage selector set to correct position.
Controller shows 'Lost comms' when a velocity sensor is connected.	Check power supply. Check wiring to velocity sensor. If the sensor has been connected to a new unit, then it may require power cycling to enable a connection to the FlowCERT's Baud rate.

CHAPTER 10 DISPOSAL

Incorrect disposal can cause adverse effects to the environment.

Dispose of the device components and packaging material in accordance with regional environmental regulations including regulations for electrical \ electronic products.

Transducers

Remove power, disconnect the Transducer, cut off the electrical cable and dispose of cable and Transducer in accordance with regional environmental regulations for electrical \ electronic products.

Controllers

Remove power, disconnect the Controller and remove battery (if fitted).

Dispose of Controller in accordance with regional environmental regulations for electrical \ electronic products.

Dispose of batteries in accordance with regional environmental regulations for batteries.



 EU WEEE Directive Logo

This symbol indicates the requirements of Directive 2012/19/EU regarding the treatment and disposal of waste from electric and electronic equipment.

NOTES



www.pulsarmeasurement.com

SUPPORT@PULSARMEASUREMENT.COM

Copyright © 2020 Pulsar Measurement Ltd.

Registered Address: 1 Chamberlain Square CS, Birmingham B3 3AX

Registered No.: 3345604 England & Wales

Rev 1.0